

---

# N6900/N7900 Series Advanced Power System

N6950A, N6951A, N6952A, N6953A, N6954A,  
N6970A, N6971A, N6972A, N6973A, N6974A, N6976A, N6977A,  
N7950A, N7951A, N7952A, N7953A, N7954A,  
N7970A, N7971A, N7972A, N7973A, N7974A, N7976A, N7977A,  
and N7909A Power Dissipator Unit



<b>Legal and Safety Information</b> .....	<b>11</b>
<b>Legal Notices</b> .....	<b>11</b>
Software .....	11
License Files .....	11
Warranty .....	12
Certification .....	12
US Government Rights .....	12
Waste Electrical and Electronic Equipment (WEEE) Directive 2002/96/EC .....	12
<b>Safety Notices</b> .....	<b>13</b>
<b>Safety Symbols</b> .....	<b>14</b>
<b>1 Quick Reference</b> .....	<b>15</b>
<b>Introduction to the Instrument</b> .....	<b>16</b>
Advanced Power System at a Glance .....	16
Front Panel at a Glance .....	17
Front Panel Display at a Glance .....	18
Front Panel Keys at a Glance .....	19
Rear Panel at a Glance .....	20
Power Dissipator at a Glance .....	21
<b>Front Panel Menu Reference</b> .....	<b>22</b>
<b>Command Quick Reference</b> .....	<b>26</b>
ABORT Subsystem .....	26
CALibrate Subsystem .....	26
DISPlay Subsystem .....	26
FETCh Subsystem .....	27
FORMat Subsystem .....	27
HCOPy Subsystem .....	28
IEEE-488 Common Commands .....	28
INITiate Subsystem .....	28
LXI Command .....	28
MEASure Subsystem .....	29
OUTPut Subsystem .....	29
SENSe Subsystem .....	30
[SOURce:]ARB Subsystem .....	31
[SOURce:]CURRent Subsystem .....	32
[SOURce:]DIGital Subsystem .....	32
[SOURce:]FUNctioN Command .....	33
[SOURce:]LIST Subsystem .....	33
[SOURce:]POWer Query .....	33
[SOURce:]Resistance Subsystem .....	34
[SOURce:]STEP Command .....	34
[SOURce:]VOLTage Subsystem .....	34
STATus Subsystem .....	35
SYSTem Subsystem .....	35
TRIGger Subsystem .....	36
<b>Model Features and Options</b> .....	<b>37</b>
Model Features .....	37
Accessories/Options .....	39

<b>Specifications and Characteristics</b> .....	<b>40</b>
Introduction .....	40
Specifications - Keysight N6900 Series .....	41
Specifications - Keysight N7900 Series .....	42
Specifications - Keysight N6900/N7900 High Voltage Series .....	44
Supplemental Characteristics - Keysight N6900 Series .....	45
Supplemental Characteristics - Keysight N7900 Series .....	49
Supplemental Characteristics - Keysight N6900/N7900 High Voltage Series .....	52
Common Characteristics .....	54
Output Impedance Graphs .....	56
Inductive Load Boundary .....	58
Output Quadrants .....	59
Voltage Programming Response .....	60
Output Dynamic Response .....	60
Measurement Accuracy and Resolution - with shorter measurement intervals .....	61
Dimension Diagrams - all dimensions in millimeters .....	62
<b>2 Installing the Instrument</b> .....	<b>65</b>
<b>Before Installation or Use</b> .....	<b>66</b>
Inspect the Unit .....	66
Check for Items Supplied .....	66
Review Safety Information .....	67
Observe Environmental Conditions .....	67
Provide Adequate Air Flow .....	67
<b>Single Unit Connections</b> .....	<b>68</b>
Line Cord Connection .....	68
Sense Connections .....	69
Output Connections .....	69
Single Load Connections .....	71
Multiple Load Connections .....	72
Remote Sense Connections .....	72
Additional Load Considerations .....	75
<b>Parallel Connections</b> .....	<b>76</b>
Parallel Description .....	76
Sharing Cable Fabrication .....	77
Load, Sense, and Sharing Connections .....	77
<b>Series Connections</b> .....	<b>79</b>
Series Description .....	79
Load, Sense, and Diode Connections .....	80
Series Diode Considerations .....	81
Capacitance Limits .....	82
Additional Cautions When Using a Boost Supply in Series .....	82
<b>Power Dissipator Connections</b> .....	<b>83</b>
The N7909A Power Dissipator .....	83
Power Cable Fabrication .....	83
Power Dissipator Connections - 1 kW Units .....	84
Power Dissipator Connections - 2 kW Units .....	85
<b>Interface Connections</b> .....	<b>86</b>

GPIB Connections .....	86
USB Connections .....	86
LAN Connections - site and private .....	87
Digital Port Connections .....	88
<b>Rack Mounting .....</b>	<b>89</b>
Installing the Instrument .....	89
<b>Black Box Recorder .....</b>	<b>91</b>
Installing the BBR .....	91
<b>3 Getting Started .....</b>	<b>92</b>
<b>Using the Front Panel .....</b>	<b>93</b>
Turn the Unit On .....	93
Set the Output Voltage .....	93
Set the Output Current .....	94
Set Over-voltage Protection .....	95
Enable the Output .....	96
Use Built-in Help System .....	97
<b>Remote Interface Configuration .....</b>	<b>98</b>
Introduction .....	98
USB Configuration .....	98
GPIB Configuration .....	98
LAN Configuration .....	99
Modifying the LAN Settings .....	100
Using the Web Interface .....	103
Using Telnet .....	104
Using Sockets .....	104
Interface Lockout .....	104
<b>4 Using the Advanced Power System .....</b>	<b>105</b>
<b>Programming the Output .....</b>	<b>106</b>
Set the Output Priority Mode .....	106
Set the Output Voltage .....	106
Set the Output Current .....	107
Set the Slew Rate .....	107
Set the Output Bandwidth .....	108
Set the Output Resistance .....	109
Enable the Output .....	110
Configure the Output Relays .....	110
<b>Programming Output Protection .....</b>	<b>112</b>
Introduction .....	112
Set the Over-Voltage Protection .....	113
Set the Over-Current Protection .....	113
Output Watchdog Timer .....	114
User-Defined Protection .....	115
Clear Output Protection Functions .....	115
Protection Shutdown Behavior .....	115
<b>Programming Output Transients .....</b>	<b>117</b>
Output Transients .....	117
Common Actions for All Transients .....	117

Programming a Step Transient .....	120
Programming a List Transient .....	121
Programming an Arbitrary Waveform .....	125
<b>Sequencing the Output .....</b>	<b>127</b>
Turn-On Turn-Off Behavior .....	127
Turn-On/Turn-Off Delays .....	128
Enabling/Disabling the Output .....	128
Sequencing Multiple Units .....	129
<b>Making Measurements .....</b>	<b>132</b>
Average Measurements .....	132
Number of Power Line Cycles (NPLC) .....	132
Measurement Windowing .....	133
Seamless Current Measurement Ranging .....	133
Amp-Hour and Watt-Hour Measurements .....	134
Temperature Measurements .....	134
Digitized Measurements .....	135
Measurement Triggering .....	137
<b>Using Expression Signal Routing .....</b>	<b>142</b>
Signal Routing Overview .....	142
Defining Signal Expressions .....	143
Configuring Threshold Comparators .....	145
Specifying Signal Expression Targets .....	146
Expression Constraints .....	147
Expression Examples .....	148
<b>Programming the Digital Port .....</b>	<b>151</b>
Digital Control Port .....	151
Bi-Directional Digital I/O .....	152
Digital Input .....	153
Expression<1-8> .....	153
External Trigger I/O .....	154
Fault Output .....	154
Inhibit Input .....	155
Fault/Inhibit System Protection .....	155
Output Couple Control .....	156
<b>External Data Logging (Elog) .....</b>	<b>158</b>
External Data Logging .....	158
Select the Measurement Function and Range .....	158
Specify the Integration Period .....	159
Select the Elog Trigger Source .....	160
Initiate and Trigger the Elog .....	160
Periodically Retrieve the Data .....	161
Terminate the Elog .....	161
<b>Black Box Data Recording .....</b>	<b>162</b>
Black Box Recorder .....	162
Logged Data .....	163
BBR Status .....	163
BBR Period .....	163
BBR Length .....	163

Snapshot Operation .....	164
Snapshot Event Tags .....	164
BBR Clock Setup .....	165
BBR Alignment .....	165
<b>Current Sharing Operation .....</b>	<b>167</b>
Introduction .....	167
Enable the Current Sharing Function .....	168
Program the On Couple and Off Couple Function .....	168
Program the Output Voltage and Current .....	169
Program a Step Function for Additional Output Changes .....	170
Enable the Output and Trigger Additional Output Changes .....	171
Specification Effects .....	172
Current Sharing Effects .....	173
<b>Current Sinking Operation .....</b>	<b>174</b>
Current Sinking .....	174
Power Dissipator Operation .....	175
Querying the Power Dissipator .....	175
<b>System-Related Operations .....</b>	<b>177</b>
Instrument Identification .....	177
Instrument State Storage .....	177
Front Panel Display .....	178
Front Panel Lock-Out .....	178
Password Protection .....	179
<b>Priority Mode Tutorial .....</b>	<b>180</b>
Voltage Priority .....	180
Current Priority .....	181
<b>Current Sharing Tutorial .....</b>	<b>182</b>
Current Sharing Calculations .....	182
Sharing Deviation for Units of Equal Power (either 1 kW or 2 kW) .....	183
Sharing Deviation for Units of Mixed Power (1 kW paralleled with 2 kW) .....	183
<b>5 Using the Power Assistant Software .....</b>	<b>185</b>
<b>Introduction .....</b>	<b>186</b>
<b>Using the Meter View .....</b>	<b>187</b>
<b>Configuring Signal Routing .....</b>	<b>189</b>
Routing Signals .....	189
Downloading the Routing .....	190
Saving the Routing File .....	191
Viewing the SCPI Commands .....	191
Source Icon Descriptions .....	192
Operator Icon Descriptions .....	193
Target Icon Descriptions .....	194
Signal Routing Examples .....	194
<b>Black Box Data Recording .....</b>	<b>198</b>
Making a Snapshot .....	198
Retrieving the Snapshot .....	198
Viewing the Snapshot .....	199
Configuring the Display .....	199

Viewing Snapshot Events .....	200
Exporting the Snapshot Data .....	201
Saving the Snapshot File .....	201
<b>6 SCPI Programming Reference .....</b>	<b>202</b>
IO Libraries and Instrument Drivers .....	202
Web Interface .....	202
Example Programs .....	202
<b>Introduction to the SCPI Language .....</b>	<b>203</b>
Introduction .....	203
Keywords .....	204
Queries .....	204
Command Separators and Terminators .....	204
Syntax Conventions .....	205
Parameter Types .....	206
Device Clear .....	207
Typical Command Processing Times .....	207
<b>Commands by Subsystem .....</b>	<b>209</b>
ABORt Subsystem .....	210
ARB Subsystem .....	211
CALibrate Subsystem .....	214
CURRent Subsystem .....	218
DIGital Subsystem .....	222
DISPlay Subsystem .....	225
FETCh Subsystem .....	226
FORMat Subsystem .....	230
FUNCTion Command .....	231
HCOPy Subsystem .....	232
IEEE-488 Common Commands .....	233
INITiate Subsystem .....	239
LIST Subsystem .....	240
LXI Command .....	243
MEASure Subsystem .....	244
OUTPut Subsystem .....	247
POWER Query .....	254
RESistance Subsystem .....	255
SENSe Subsystem .....	256
[SOURce] Subsystem .....	263
STATus Subsystem .....	264
STEP Command .....	269
SYSTem Subsystem .....	270
TRIGger Subsystem .....	276
VOLTage Subsystem .....	280
<b>Status Tutorial .....</b>	<b>285</b>
Status Registers .....	285
Operation Status Group .....	285
Questionable Status Group .....	286
Standard Event Status Group .....	287

Status Byte Register .....	288
Error and Output Queues .....	288
Status Diagram .....	289
<b>Trigger Tutorial .....</b>	<b>290</b>
Trigger Sources .....	290
Trigger Destinations .....	290
Trigger Diagram .....	291
<b>Reset State (*RST) .....</b>	<b>292</b>
<b>SCPI Error Messages .....</b>	<b>296</b>
<b>Compatibility Commands .....</b>	<b>304</b>
Channel Parameter .....	304
Aliased Commands .....	304
Code Compatible Commands .....	304
Commands and Parameters that Work Differently .....	306
<b>7 Verification and Calibration .....</b>	<b>307</b>
<b>Recommended Test Equipment and Setups .....</b>	<b>308</b>
Test Equipment .....	308
Measurement Techniques .....	309
Test Considerations .....	309
Verification Setups .....	310
Calibration Setups .....	310
<b>Performance Verification .....</b>	<b>311</b>
Introduction .....	311
Voltage Programming and Readback Accuracy .....	311
Constant Voltage Load Effect .....	312
Constant Voltage Ripple and Noise .....	312
Transient Recovery Time .....	313
Current Programming and Readback Accuracy .....	314
Constant Current Load Effect .....	314
Current Sink Capability Verification .....	315
<b>Calibration Procedure .....</b>	<b>316</b>
Introduction .....	316
Calibration Interval .....	317
Enter Calibration Mode .....	317
Voltage Calibration .....	317
Voltage Common Mode Rejection Ratio Calibration .....	318
Current Temperature Coefficient Calibration .....	318
Current Calibration .....	319
Current Sharing Calibration .....	320
Resistance Bottom-Out Calibration .....	321
Enter a Calibration Date .....	321
Save Calibration and Log Out .....	321
<b>Test Record Forms .....</b>	<b>322</b>
N6950A/N6970A .....	322
N6951A/N6971A .....	323
N6952A/N6972A .....	324
N6953A/N6973A .....	325

N6954A/N6974A .....	326
N6950A/N6970A with Option 301 .....	327
N6951A/N6971A with Option 301 .....	328
N6952A/N6972A with Option 301 .....	329
N6953A/N6973A with Option 301 .....	330
N6954A/N6974A with Option 301 .....	331
N7950A/N7970A .....	332
N7951A/N7971A .....	333
N7952A/N7972A .....	334
N7953A/N7973A .....	335
N7954A/N7974A .....	336
N6976A .....	337
N6977A .....	338
N7976A and N6976A with Option 301 .....	339
N7977A and N6977A with Option 301 .....	340
<b>8 Service and Maintenance .....</b>	<b>341</b>
<b>Introduction .....</b>	<b>342</b>
Types of Service Available .....	342
Before Returning the Unit .....	342
Repackaging for Shipment .....	342
Cleaning .....	343
<b>Self-Test Procedure .....</b>	<b>344</b>
Power-On Self-Test .....	344
User-Initiated Self-Test .....	344
<b>Firmware Update .....</b>	<b>345</b>
Firmware Versions .....	345
Software Required .....	345
Update Procedure .....	346
Restricting Access .....	346
<b>Option Installation .....</b>	<b>347</b>
Obtaining the License .....	347
<b>Instrument Sanitize .....</b>	<b>348</b>
Sanitizing the Black Box Recorder .....	348
<b>Calibration Switches .....</b>	<b>349</b>
Accessing the Calibration Switch .....	349
Switch Functions .....	349
<b>Battery Replacement .....</b>	<b>350</b>
Installing the Battery .....	350
<b>Redundant Ground for 400 Hz Operation .....</b>	<b>352</b>
Hardware and Tools Required (customer -supplied) .....	352
Installation Procedure .....	352
<b>Disassembly .....</b>	<b>353</b>
Electrostatic Discharge (ESD) Precautions .....	353
Tools Required .....	353
General Disassembly Procedure .....	353
<b>Index .....</b>	<b>355</b>

## Legal and Safety Information

### Legal Notices

### Safety Notices

### Safety Symbols

## Legal Notices

© Copyright Keysight Technologies 2013 - 2023, 2024, 2026

Edition 10, updated March 2026

Manual part number N7900-90901

No part of this manual may be reproduced in any form or by any means (including electronic storage and retrieval or translation into a foreign language) without prior agreement and written consent from Keysight Technologies as governed by United States and international copyright laws.

Keysight Technologies  
550 Clark Drive, Suite 101  
Budd Lake, NJ 07828 USA

## Software

This product uses Microsoft Windows CE. Keysight highly recommends that all Windows-based computers connected to Windows CE instruments use current anti-virus software.

The hardware and/or software described in this document are furnished under a license and may be used or copied only in accordance with the terms of such license.

## License Files

From gifencode C source code:

- \* Code drawn from ppmtogif.c, from the pbmplus package Based on GIFENCOD
- \* by David Rowley <mgardi@watdscu.waterloo.edu>. A Lempel-Zim
- \* compression based on "compress". Modified by Marcel Wijkstra
- \* <wijkstra@fwi.uva.nl> Copyright (C) 1989 by Jef Poskanzer. Permission
- \* to use, copy, modify, and distribute this software and its
- \* documentation for any purpose and without fee is hereby granted,
- \* provided that the above copyright notice appear in all copies and that
- \* both that copyright notice and this permission notice appear in
- \* supporting documentation. This software is provided "as is" without
- \* express or implied warranty. The Graphics Interchange Format(c) is the
- \* Copyright property of CompuServe Incorporated. GIF(sm) is a Service
- \* Mark property of CompuServe Incorporated. ;

## Warranty

The material contained in this document is provided "as is," and is subject to being changed, without notice, in future editions. Further, to the maximum extent permitted by applicable law, Keysight disclaims all warranties, either express or implied, with regard to this manual and any information contained herein, including but not limited to the implied warranties of merchantability and fitness for a particular purpose. Keysight shall not be liable for errors or for incidental or consequential damages in connection with the furnishing, use, or performance of this document or of any information contained herein. Should Keysight and the user have a separate written agreement with warranty terms covering the material in this document that conflict with these terms, the warranty terms in the separate agreement shall control.

## Certification

Keysight Technologies certifies that this product met its published specifications at time of shipment from the factory. Keysight Technologies further certifies that its calibration measurements are traceable to the United States National Institute of Standards and Technology, to the extent allowed by the Institute's calibration facility, and to the calibration facilities of other International Standards Organization members

## US Government Rights

The Software is "commercial computer software," as defined by Federal Acquisition Regulation ("FAR") 2.101. Pursuant to FAR 12.212 and 27.405-3 and Department of Defense FAR Supplement ("DFARS") 227.7202, the U.S. government acquires commercial computer software under the same terms by which the software is customarily provided to the public. Accordingly, Keysight provides the Software to U.S. government customers under its standard commercial license, which is embodied in its End User License Agreement (EULA), a copy of which can be found at [www.keysight.com/find/sweula](http://www.keysight.com/find/sweula). The license set forth in the EULA represents the exclusive authority by which the U.S. government may use, modify, distribute, or disclose the Software. The EULA and the license set forth therein, does not require or permit, among other things, that Keysight: (1) Furnish technical information related to commercial computer software or commercial computer software documentation that is not customarily provided to the public; or (2) Relinquish to, or otherwise provide, the government rights in excess of these rights customarily provided to the public to use, modify, reproduce, release, perform, display, or disclose commercial computer software or commercial computer software documentation. No additional government requirements beyond those set forth in the EULA shall apply, except to the extent that those terms, rights, or licenses are explicitly required from all providers of commercial computer software pursuant to the FAR and the DFARS and are set forth specifically in writing elsewhere in the EULA. Keysight shall be under no obligation to update, revise or otherwise modify the Software. With respect to any technical data as defined by FAR 2.101, pursuant to FAR 12.211 and 27.404.2 and DFARS 227.7102, the U.S. government acquires no greater than Limited Rights as defined in FAR 27.401 or DFAR 227.7103-5 (c), as applicable in any technical data.

## Waste Electrical and Electronic Equipment (WEEE) Directive 2002/96/EC

This product complies with the WEEE Directive 2002/96/EC) marketing requirement. The affixed product label (see below) indicates that you must not discard this electrical/electronic product in domestic household waste.

Product Category: With reference to the equipment types in the WEEE directive Annex 1, this product is classified as "Monitoring and Control instrumentation" product.

Do not dispose in domestic household waste.

To return unwanted products, contact your local Keysight office.



## Safety Notices

The following general safety precautions must be observed during all phases of operation of this instrument. Failure to comply with these precautions or with specific warnings or instructions elsewhere in this manual violates safety standards of design, manufacture, and intended use of the instrument. Keysight Technologies assumes no liability of the customer's failure to comply with the requirements.

**WARNING**

### General

Do not use this product in any manner not specified by the manufacturer. The protective features of this product may be impaired if it is used in a manner not specified in the operation instructions.

**WARNING**

### Before Applying Power

Verify that all safety precautions are taken. Make all connections to the unit before applying power. Note the instrument's external markings described under "Safety Symbols".

**WARNING**

### SHOCK HAZARD Ground the Instrument

This product is provided with protective earth terminals. To minimize shock hazard, the instrument must be connected to the AC power mains through a grounded power cable, with the ground wire firmly connected to an electrical ground (safety ground) at the power outlet. Any interruption of the protective (grounding) conductor or disconnection of the protective earth terminal will cause a potential shock hazard that could result in personal injury..

**WARNING**

### Do Not Operate in an Explosive Atmosphere

Do not operate the instrument in the presence of flammable gases or fumes.

**WARNING**

### Do Not Remove the Instrument Cover

Only qualified, service-trained personnel who are aware of the hazards involved should remove instrument covers. Always disconnect the power cable and any external circuits before removing the instrument cover.

**WARNING**

### Fuses

The instrument contains an internal fuse, which is not user accessible.

**WARNING**

### Do Not Modify the Instrument

Do not install substitute parts or perform any unauthorized modification to the product. Return the product to a Keysight Sales and Service Office for service and repair to ensure that safety features are maintained.

**WARNING**

### In Case of Damage

Instruments that appear damaged or defective should be made inoperative and secured against unintended operation until they can be repaired by qualified service personnel.

## Safety Symbols

**WARNING**

A WARNING notice denotes a hazard. It calls attention to an operating procedure, practice, or the like that, if not correctly performed or adhered to, could result in personal injury or death. Do not proceed beyond a WARNING notice until the indicated conditions are fully understood and met.

**CAUTION**

A CAUTION notice denotes a hazard. It calls attention to an operating procedure, practice, or the like that, if not correctly performed or adhered to, could result in damage to the product or loss of important data. Do not proceed beyond a CAUTION notice until the indicated conditions are fully understood and met.



Direct current



Alternating current



Frame or chassis terminal



Standby supply. Unit is not completely disconnected from AC mains when switch is off.



Caution, risk of electric shock



Caution, refer to accompanying documents



Earth ground terminal



The CE mark is a registered trademark of the European Community.



The ETL mark is a registered trademark of Intertek.



The C-tick mark is a registered trademark of the Spectrum Management Agency of Australia. This signifies compliance with the Australian EMC Framework regulations under the terms of the Radio Communications Act of 1992.



South Korean Class A EMC Declaration  
This equipment is Class A suitable for professional use and is for use in electromagnetic environments outside of the home.



Contains one or more of the 6 hazardous substances above the maximum concentration value (MCV), 40 Year EPUP.

1SM1-A

This text indicates that the instrument is an Industrial Scientific and Medical Group 1 Class A product (CISPER 11, Clause 4).

ICES/NMB-001

This text indicates product compliance with the Canadian Interference- Causing Equipment Standard (ICES-001).

# 1

## Quick Reference

**Legal and Safety Information**

**Introduction to the Instrument**

**Front Panel Menu Reference**

**Command Quick Reference**

**Model Features and Options**

**Specifications and Characteristics**

This document includes user, service, and programming information for the Keysight Regenerative Power System (RPS) Family.

### **Documentation, Firmware, and Technical Support**

This document is provided on a Product Reference CD that is shipped with your instrument. You can also download this document at [www.keysight.com/find/APS-doc](http://www.keysight.com/find/APS-doc). Manuals are available under Technical Support in the Document Library tab.

For the latest firmware revision go to [Firmware Updates](#).

If you have questions about your shipment, or if you need information about warranty, service, or technical support, contact Keysight Technologies.

Contacting Keysight Technologies

Use [www.keysight.com/find/assist](http://www.keysight.com/find/assist) for information on contacting Keysight worldwide, or contact your Keysight Technologies Representative.

If you find a Keysight product or solution is impacted by a cybersecurity issue, please report it using this link: [Report a Product Cybersecurity Issue | Keysight](#)

© Copyright Keysight Technologies 2013 - 2021

## Introduction to the Instrument

### **Advanced Power System at a Glance**

#### **Front Panel at a Glance**

#### **Front Panel Display at a Glance**

#### **Front Panel Keys at a Glance**

#### **Rear Panel at a Glance**

#### **Power Dissipator at a Glance**

## **Advanced Power System at a Glance**

The Advanced Power System (APS) includes 1U and 2U rack-mountable DC power supplies and power dissipators with performance and features that are optimized for automated test systems.

The APS models are available in power levels of 1 kW and 2 kW. Voltage levels range from 9 V to 160 V. Current levels range from 12.5 A to 200 A.

The output and system features are described as follows. Not all output features are available on every power supply. The **Models and Options** section describes the features that apply only to specific models.

### **Output features**

- Full programming capability is provided for the entire range of output voltage and current
- Output can operate in voltage priority or current priority mode
- High-speed up and down output programming
- Output resistance programming
- Turn-on/turn-off delays allow output on/off sequencing across multiple units
- Current sharing capability for paralleled outputs
- Protection capability includes over-voltage, over-current, over-temperature, and open sense lead detection
- Two-quadrant operation provides current sourcing and sinking capability
- 10% rated current-sink capability standard; 100% rated current-sink capability with N7909A power dissipators
- Output disconnect relays are included on N7900 models, and are available as options on N6900 models

## Measurement features

- 5.12  $\mu$ s sample rate
- Real-time power measurements
- Amp-Hour and Watt-Hour Measurements
- Seamless current measurements across ranges on **N7900 models** and **N6900 Opt 301**
- Digitized measurement capability on N7900 models **N7900 models** and **N6900 Opt 302**
- Continuous "external" data logging on N7900 models **N7900 models** and **N6900 Opt 302**
- Continuous "Black Box" data recording available as an installable accessory

## System features

- Save and recall up to 10 instrument states in non-volatile memory
- Customized signal routing capability
- GPIB (IEEE-488), LAN, and USB remote programming interfaces are built in
- Front panel menu setup for GPIB and LAN parameters
- LXI Core 2011 compliant, including a built-in Web server
- SCPI (Standard Commands for Programmable Instruments) compatibility

## Front Panel at a Glance

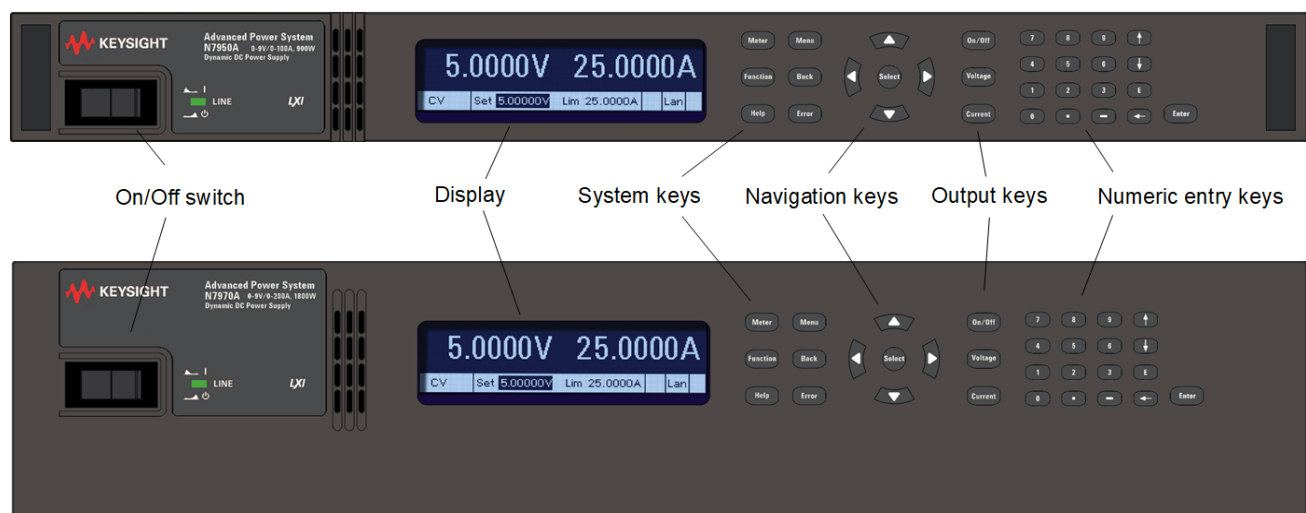

## Front Panel Display at a Glance

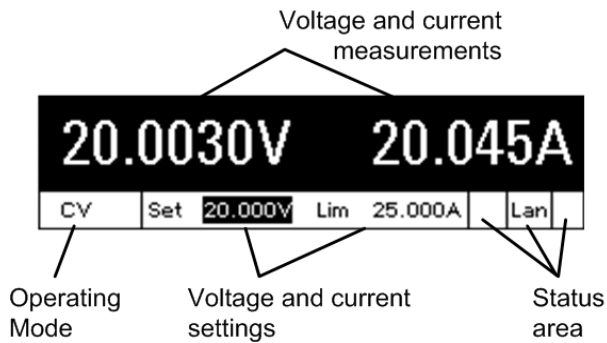

<b>Voltage and current measurements</b>	Displays the actual output voltage and current
<b>Operating mode</b>	Indicates one of the following: OFF = the output is off CV = the output is in constant voltage mode CC = the output is in constant current mode CP+ = the output is disabled by the positive power limit CP- = the output is disabled by the negative power limit VL+ = the output is in positive voltage limit mode CL+/- = the output is in positive or negative current limit mode OV = the output is disabled by the over-voltage protection OV- = the output is disabled by the negative over-voltage protection OC = the output is disabled by the over-current protection OT = the over-temperature protection has tripped PF = the output is disabled by a power-fail condition SF = a sense lead fault has been detected P = the instrument has been paralleled with another instrument Inh = the output is disabled by an external inhibit signal Unr = the output is unregulated Prot = the output is disabled by a protection condition on another unit Edp = the output is disabled by excessive output dynamics protection UProt = a user-defined protection signal has disabled the output IPK+/- = the output is in positive or negative peak current limit CSF = a current sharing fault has occurred T-on = the output is turning on T-off = the output is turning off
<b>Voltage and current settings</b>	Displays the programmed voltage and current. These settings may not match the measured output voltage or current. For example, in constant voltage operation, the output current setting (limit) may be set to 1 A, but the actual (measured) output current must be less than 1 A for the output to remain in constant voltage mode. If the Current limit is reached, the output will no longer be operating in constant voltage mode, but will be in current limit mode. In this case, the actual output voltage will now be less than the output voltage setting.
<b>Status area</b>	Indicates the following remote interface activity: Err = an error has occurred (press Error key to display error message) Lan = the LAN is connected and has been configured IO = there is activity on one of the remote interfaces

## Front Panel Keys at a Glance

The following table lists the main parts of the front panel, generally from left to right:

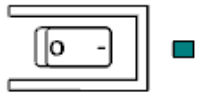

The On/Off switch turns the unit on or off. The indicator next to the On/Off switch shows the display status. **Green** indicates normal operation. **Yellow** indicates that the display is in screen saver mode. It is also on during the boot-up process. Press any key to exit screen saver mode.

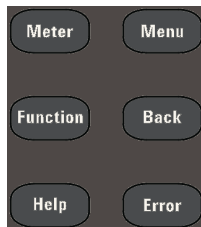

The System keys access the following front panel meter and command menus:

Meter returns the display to metering mode. Also toggles between current and power measurements.

Menu accesses the command menu.

Function key is reserved for future use.

Back backs out of a menu without activating any changes.

Help accesses information about the displayed menu control.

Error displays any error messages in the error queue.

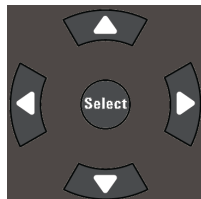

The navigation keys do the following:

The Arrow keys move around in the command menus. They also select alpha characters in alpha-numeric entry fields.

The Select key lets you make a selection in the command menus. It also lets you enter edit mode for editing the numeric parameters.



The Output keys do the following:

On/Off controls the output.

Voltage lets you change the voltage setting.

Current lets you change the current setting.



The Numeric entry keys do the following:

The 0 through 9 keys enter numbers.

The (.) key is the decimal point.

The - key is used to enter a minus sign.

The up/down arrow keys increment or decrement voltage or current settings. They also select letters in alphabetic entry fields.

The E key enters an exponent. Add the value to the right of the E.

The Backspace key deletes digits as it backspaces over them.

The Enter key enters a value. If you exit a field without pressing the Enter key, the value is ignored.

### NOTE

Press the Help key to get context sensitive help.

## Rear Panel at a Glance

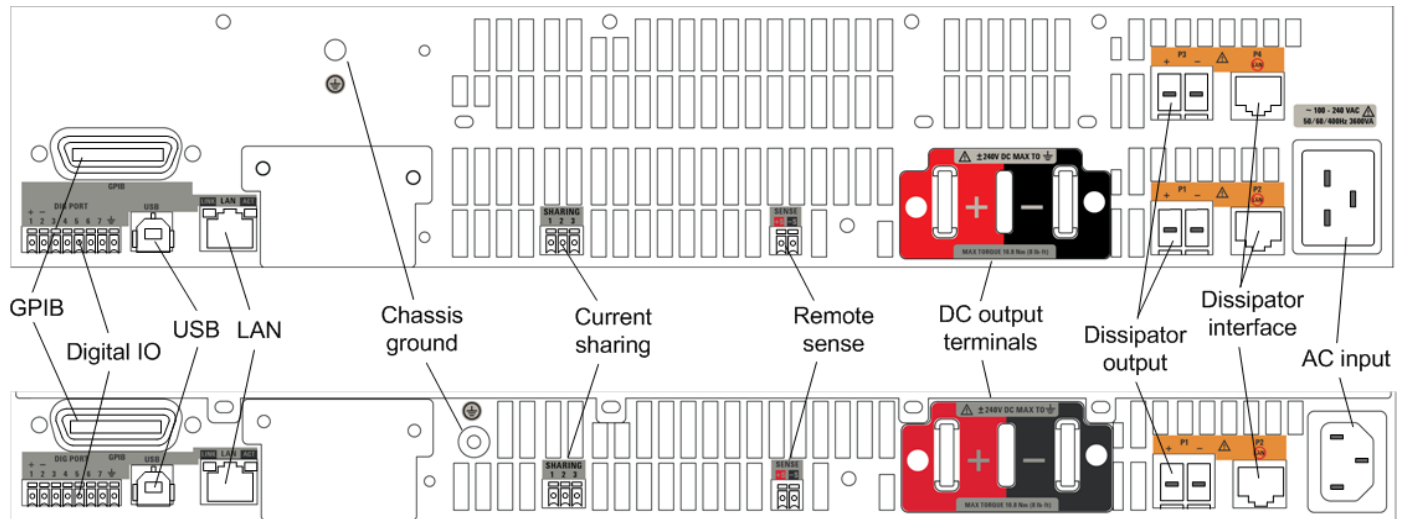

The following table lists the main parts of the rear panel, generally from left to right:

GPIB	The GPIB interface connector
Digital IO	The digital IO pins
USB	The USB interface connector
LAN	The LAN interface connector
Chassis ground	The chassis ground terminal. Provides an earth ground
Current sharing	The current sharing connector
Remote sense	The remote sense terminals
DC output	The positive and negative output terminals
P1 Dissipator output	Power connections to the N7909A. 1 kW power supplies require one power dissipator. 2 kW power supplies require two power dissipators to sink the rated output power.
P2 Dissipator interface	Power dissipator interface. One interface required per dissipator. Only connect the supplied CAT6A cable to the P2 interface.
AC input	The AC lint input

### WARNING

For protection from electrical shock, the power cord ground must not be defeated. If only a two-contact electrical outlet is available, connect the instrument's chassis ground screw (see above) to a good earth ground.

## Power Dissipator at a Glance

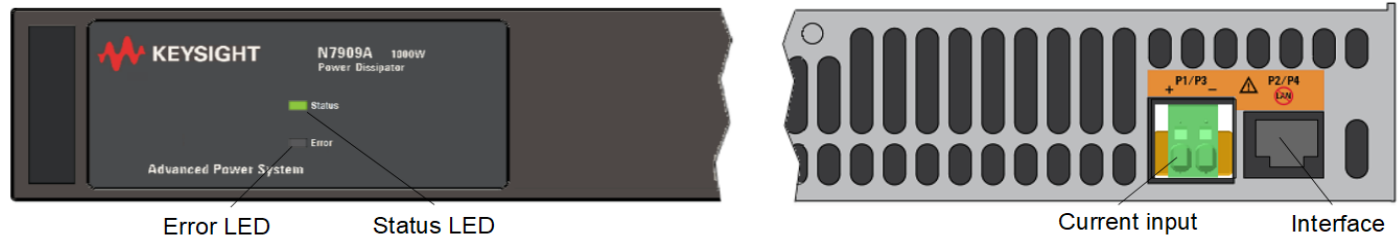



The following table lists the main parts of the front and rear panels:

Status LED	Green - the N7909A has been recognized by the power supply and is fully operational. Yellow - power is available, but no communication established with the power supply.
Error LED	Red - a fault has occurred. This can occur because a cable has been disconnected or because of a hardware failure. The LED will flash in case of a thermal overload.
P1/P3 Current input	The power connections to the power supply. 1 kW power supplies require one power dissipator. 2 kW power supplies require two power dissipators to sink the rated output power.
P2/P4 Interface	The N7909A interface. One interface connection is required for each power dissipator. Only connect the supplied CAT6A cable to the P2 interface.

## Front Panel Menu Reference

This is an overview of the front-panel menus. Press the **Menu** key to access the front panel menus.

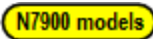
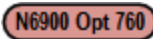
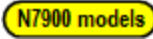
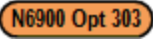
For a brief tutorial on how to navigate the front panel menu, refer to [Use the front panel menu](#).

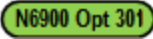
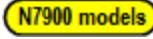
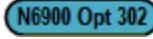
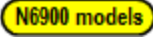
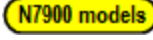
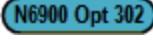
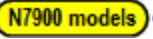
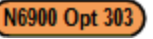
1st Menu Level	2nd Level	3rd & 4th Levels	Description	
<b>Output</b>	Voltage		Programs output voltage settings	
	Current		Programs output current settings	
	Mode		Programs output priority mode	
	Sequence		Displays sequence commands	
		Delay		Programs output on/off delay
		Couple		Configures output state coupling
	Advanced			Displays Advanced commands
		Slew		Programs output current or voltage slew rates
		Polarity		Programs output polarity  
		Resistance		Programs output resistance
		Bandwidth		Programs output voltage bandwidth Specifies the low-pass pole frequency  
		CurrSharing		Enables/disables output current sharing
<b>Measure</b>	Range		Select current measurement range  	
	Sweep		Configures measurement sampling  	
	NPLC		Specifies number of power line cycles 	
	Window		Select measurement window  	
	Control		Initiates, triggers, and aborts acquisitions; displays trig state	
	AhWh		Measures or resets amp-hours and watt hours	
	Temp		Displays ambient temperature and over-temperature margin	
<b>Transient</b>	Mode		Selects voltage and current transient modes	
	Step		Configures voltage or current steps and trigger signals	
	List		Displays List commands  	

1st Menu Level	2nd Level	3rd & 4th Levels	Description
		Pace	Specifies Dwell or Trigger paced list
		Repeat	Specifies number of list repetitions, or continuous list
		Terminate	Specifies list termination conditions
		Config	Configures individual list step settings
		Reset	Aborts the list and resets all list settings
	Arb		Displays Arb commands <b>N7900 models</b> <b>N6900 Opt 303</b>
		Repeat	Specifies number of Arb repetitions, or continuous Arb
		Terminate	Specifies Arb termination conditions
		Config	Configures individual Arb settings
	TrigSource		Specifies the transient and CD Arb trigger source
	Control		Initiates, triggers, and aborts transients; displays trig state
<b>Protect</b>	OVP		Configures over-voltage protection settings
	OCP		Configures over-current protection settings
	Inhibit		Configures inhibit input mode settings
	WDog		Configures output watchdog protections settings
	SFD		Enables/disables sense fault detection
	Mode		Specifies turn-off behavior for all protection conditions
	Clear		Clears protection conditions and displays output status
<b>States</b>	Reset		Resets all instrument settings to the reset (*RST) state
	SaveRecall		Saves and recalls instrument settings
	PowerOn		Selects the power-on instrument state
<b>System</b>	IO		Displays IO commands
		LAN	Displays LAN commands
		Settings	View the currently active network settings
		Modify	Modify the network configuration (IP, Name, DNS, WINS, mDNS, Services)
		Apply	Applies the configuration changes and restarts unit
		Cancel	Cancels the configuration changes
		Reset	Performs an LXI LCI reset of LAN settings and restarts

## 1 Quick Reference

1st Menu Level	2nd Level	3rd & 4th Levels	Description
		Defaults	Resets the network to the as-shipped defaults and restarts
		USB	Displays USB identification string
		GPIB	Display or change the GPIB address
		DigPort	Displays DigPort commands
		Pins	Configures the individual digital port pins
		Data	Reads/writes data to the digital port
	BBR		Displays Black Box Recorder commands
		Status	Displays the BBR status
		Period	Configures the BBR logging period
		Snapshot	Takes a snapshot of the BBR data
	Signal		Displays signal commands
		Define	Defines the individual signal expressions
		Couple	Configures the output on/output couple source
		Protect	Configures the user-protection function
		Status	Configures the user-status source
		Threshold	Configures the signal threshold comparators
	Preferences		Displays Preferences commands
		Clock	Sets the real-time clock for the Black Box Recorder
		Display	Configures the screen saver and start-up meter view
		LineFreq	Sets the line frequency preferences
		Lock	Locks the front panel keys with a password
		Relay	Sets the output relay preferences <b>N7900 models</b> <b>N6900 Opt 760</b> <b>N6900 Opt 761</b>
	Admin		Displays Admin commands
		Login	Enter a password to access the Admin functions
		Cal	Displays calibration commands
		Vprog	Calibrates voltage programming
		Curr	Calibrates current programming and measurement
		Misc	Calibrates CMRR, CurrTC, CurrSharing, and ResBout

1st Menu Level	2nd Level	3rd & 4th Levels	Description
		Count	View the calibration count
		Date	Saves the calibration date
		Save	Saves the calibration data
		IO	Enables/disables the LAN, USB, and GPIB
		Sanitize	Performs NISPOM secure erase of all user data
		Update	Password protected firmware update
		Options	Installs firmware options
		Password	Changes the admin password
	About		Displays model, options, serial number, and firmware

## Command Quick Reference

Some [optional] commands have been included for clarity. All settings commands have a corresponding query. See the [Syntax Conventions](#) for SCPI.

### ABORT Subsystem

#### ABORt

- :ACQuire Cancels any triggered measurements.
- :ELOG Stops external data logging.
- :TRANsient Cancels any triggered actions.

### CALibrate Subsystem

#### CALibrate

- :COUNT? Returns the number of times the unit has been calibrated.
- :CURRent
  - [[:LEVel] <value> Calibrates the current programming and measurement.
  - :MEASure <value> Calibrates the low range current measurement.
  - :SHARing Calibrates the Imon signal for paralleled units.
  - :TC Calibrates the temperature coefficient.
- :DATA <value> Enters the calibration value read by the external meter.
- :DATE <"date"> Enters the calibration date in nonvolatile memory.
- :LEVel P1|P2|P3 Advances to the next level in the calibration.
- :PASSword <value> Sets a numeric password to prevent unauthorized calibration.
- :RESistance
  - :BOUT Calibrates the bottom out resistance.
- :SAVE Saves the calibration constants in non-volatile memory.
- :STATe 0|OFF|1|ON Enables or disables calibration mode.
- :VOLTage
  - [[:LEVel] <value> Calibrates the local voltage programming and measurement.
  - :CMRR Calibrates the voltage common mode rejection ratio.

### DISPlay Subsystem

#### DISPlay

- [[:WINDow]
  - [[:STATe] 0|OFF|1|ON Turns the front panel display on or off.
  - :VIEW METER\_VI|METER\_VP|METER\_VIP Selects the parameters to display on the front panel.
- :SAVer
  - [[:STATe] 0|OFF|1|ON Turns the front panel screen saver on or off.

## FETCH Subsystem

### FETCH

[ :SCALar ]

:CURRent

[ :DC ]? [ <start\_index>, <points> ] Returns the averaged measurement.

:ACDC? Returns the RMS measurement (AC + DC).

:HIGH? Returns the High level of a pulse waveform.

:LOW? Returns the Low level of a pulse waveform.

:MAXimum? Returns the maximum or minimum value.

:MINimum?

:POWer

[ :DC ]? Returns the averaged measurement.

:MAXimum? Returns the maximum or minimum value.

:MINimum?

:VOLTagE

[ :DC ]? [ <start\_index>, <points> ] Returns the averaged measurement.

:ACDC? Returns the RMS measurement (AC + DC).

:HIGH? Returns the High level of a pulse waveform.

:LOW? Returns the Low level of a pulse waveform.

:MAXimum? Returns the maximum or minimum value.

:MINimum?

:AHOuR? [IGNORE\_OVLD] Returns the accumulated amp-hours.

:ARRAY

:CURRent

[ :DC ]? [ <start\_index>, <points> ] Returns the instantaneous measurement.

:POWer

[ :DC ]? Returns the instantaneous measurement.

:VOLTagE

[ :DC ]? [ <start\_index>, <points> ] Returns the instantaneous measurement.

:ELOG? <maxrecords> Returns the most recent external datalog records.

:WHOuR? [IGNORE\_OVLD] Returns the accumulated watt-hours.

## FORMat Subsystem

### FORMat

[ :DATA ] ASCII | REAL Specifies the format of the returned data.

:BORDER NORMal | SWAPPed Specifies how binary data is transferred.

## HCOPy Subsystem

HCOPy

:SDUMp

:DATA? [BMP|GIF|PNG] Returns an image of the front panel display.

:DATA

:FORMat BMP|GIF|PNG Specifies the format for front panel images returned.

## IEEE-488 Common Commands

- \*CLS Clear status command.
- \*ESE <value> Event status enable command and query.
- \*ESR? Event status event query.
- \*IDN? Identification Query.
- \*LRN? Returns a sequence of SCPI commands.
- \*OPC Sets the OPC (operation complete) bit in the standard event register.
- \*OPC? Returns a 1 to the output buffer when all pending operations complete.
- \*OPT? Returns a string identifying any installed options.
- \*RCL <value> Recalls a saved instrument state.
- \*RST Resets the instrument to pre-defined values that are either typical or safe.
- \*SAV <value> Saves the instrument state to one of ten non-volatile memory locations.
- \*SRE <value> Service request enable command and query.
- \*STB? Status byte query.
- \*TRG Trigger command.
- \*TST? Self-test query.
- \*WAI Pauses additional command processing until all pending operations are complete.

## INITiate Subsystem

INITiate

[:IMMEDIATE]

:ACQUIRE Initiates the measurement trigger system.

:ELOG Initiates external data logging.

:TRANSient Initiates the transient trigger system.

:CONTinuous

:TRANSient 0|OFF|1|ON Continuously initiates the transient trigger system.

## LXI Command

LXI

:IDENTify

:STATe 0|OFF|1|ON Turns the front panel LXI identify indicator on or off.

## MEASure Subsystem

### MEASure

#### [ :SCALar ]

#### :CURRent

- [ :DC ]? Takes a measurement; returns the averaged current.
- :ACDC? Takes a measurement; returns the RMS current (AC + DC).
- :HIGH? Takes a measurement; returns the High level of a current pulse.
- :LOW? Takes a measurement; returns the Low level of a current pulse.
- :MAXimum? Takes a measurement; returns the maximum current.
- :MINimum? Takes a measurement; returns the minimum current.

#### :POWER

- [ :DC ]? Takes a measurement; returns the averaged power.
- :MAXimum? Takes a measurement; returns the maximum power.
- :MINimum? Takes a measurement; returns the minimum power.

#### :VOLTage

- [ :DC ]? Takes a measurement; returns the averaged voltage.
- :ACDC? Takes a measurement; returns the RMS voltage (AC + DC).
- :HIGH? Takes a measurement; returns the High level of a voltage pulse.
- :LOW? Takes a measurement; returns the Low level of a voltage pulse.
- :MAXimum? Takes a measurement; returns the maximum voltage.
- :MINimum? Takes a measurement; returns the minimum voltage.

#### :ARRAY

#### :CURRent

- [ :DC ]? Takes a measurement; returns the instantaneous current.

#### :POWER

- [ :DC ]? Takes a measurement; returns the instantaneous power.

#### :VOLTage

- [ :DC ]? Takes a measurement; returns the instantaneous voltage.

## OUTPut Subsystem

### OUTPut

#### [ :STATe ] 0|OFF|1|ON

Enables or disables the output.

#### :COUPlE

##### [ :STATe ] 0|OFF|1|ON

Enables or disables output coupling.

##### :DOFFset <value>

Sets a delay offset to synchronize coupled output state changes.

#### :MAX

##### :DOFFset?

Returns the delay offset required for this instrument.

#### :OFF

##### :SOURce EXPReSSion<1-8>|NONE

Sets the off-couple signal source to an expression.

#### :ON

## 1 Quick Reference

<code>:SOURce EXPReSSion&lt;1-8&gt; NONE</code>	Sets the on-couple signal source to an expression.
<code>:DELay</code>	
<code>:FALL &lt;value&gt;</code>	Sets the output turn-off sequence delay.
<code>:RISE &lt;value&gt;</code>	Sets the output turn-on sequence delay.
<code>:INHibit</code>	
<code>:MODE LATChing LIVE OFF</code>	Sets the operating mode of the remote inhibit digital pin.
<code>:PON</code>	
<code>:STATe RST RCL0</code>	Sets the output power-on state.
<code>:PROTection</code>	
<code>:CLEAr</code>	Resets the latched protection.
<code>:MODE</code>	Sets the turn-off behavior for all protection conditions.
<code>:TEMPerature</code>	
<code>:MARGin?</code>	Returns the margin remaining before the over-temperature trips.
<code>:USER</code>	
<code>[ :STATe] 0 OFF 1 ON</code>	Enables or disables the user-defined protection.
<code>:SOURce EXPReSSion&lt;1-8&gt; NONE</code>	Sets the user-defined protection source to an expression.
<code>:WDOG</code>	
<code>[ :STATe] 0 OFF 1 ON</code>	Enables or disables the I/O watchdog timer.
<code>:DELay &lt;value&gt;</code>	Sets the watchdog delay time.
<code>:RELay</code>	
<code>:LOCK</code>	
<code>[ :STATe] 0 OFF 1 ON</code>	Enables or disables the locked-closed state of the output relays.
<code>:POLarity NORMAl REVerse</code>	Sets the polarity of the output relays.
<code>:ENABle 0 OFF 1 ON</code>	Enables or disables the polarity reversal function.

## SENSe Subsystem

### SENSe

<code>:AHOuR</code>	
<code>:RESet</code>	Resets the amp-hour or watt-hour measurement to zero.
<code>:BBR</code>	
<code>:PERiod &lt;value&gt;</code>	Sets the recording period of the black box recorder in seconds.
<code>:CURRent</code>	
<code>[ :DC]</code>	
<code>:RANGe</code>	
<code>[ :UPPer] &lt;value&gt;</code>	Selects a DC current measurement range.
<code>:AUTO 0 OFF 1 ON</code>	Enables or disables seamless measurement auto ranging.
<code>:ELOG</code>	
<code>:CURRent</code>	
<code>[ :DC]</code>	
<code>:RANGe</code>	
<code>[ :UPPer] &lt;value&gt;</code>	Selects the Elog current measurement range.
<code>:AUTO 0 OFF 1 ON</code>	Enables or disables Elog seamless measurement autoranging.

:FUNction	
:CURRent 0 OFF 1 ON	Enables/disables current data logging.
:MINMax 0 OFF 1 ON	Enables/disables min/max current data logging.
:VOLTage 0 OFF 1 ON	Enables/disables voltage data logging.
:MINMax 0 OFF 1 ON	Enables/disables min/max voltage data logging.
:PERiod <value>	Sets the integration time of an Elog measurement.
:FAULt	
:STATe 0 OFF 1 ON	Enables or disables remote sense fault detection.
:SWEep	
:NPLCycles <value>	Sets the measurement time in number of power line cycles.
:OFFSet	
:POINts <value>	Defines the offset in a data sweep for triggered measurements.
:POINts <value>	Defines the number of points in a measurement.
:TINterval <value>	Defines the time period between measurement samples.
:THReshold<1 2 3 4>	
:AHOur	
[:LEVel] <value>	Sets the amp-hour level for comparator 1,2,3, or 4.
:CURRent	
[:LEVel] <value>	Sets the current level for comparator 1,2,3, or 4.
:FUNction	Sets the sensing function for comparator 1,2,3, or 4.
VOLT CURR POW AHO WHO	
:OPERation GT LT	Sets the comparison type for comparator 1,2,3, or 4.
:POWer	
[:LEVel] <value>	Sets the power level for comparator 1,2,3, or 4.
:VOLTage	
[:LEVel] <value>	Sets the voltage level for comparator 1,2,3, or 4.
:WHOur	
[:LEVel] <value>	Sets the watt-hour level for comparator 1,2,3, or 4.
:WHOur	
:RESet	Resets the accumulated watt-hour measurement.
:WINDow	
[:TYPE] HANNing RECTangular	Selects the measurement window.

## [SOURce:]ARB Subsystem

[SOURce:]	
ARB	
:COUNT <value> INFinity	Specifies the number of times the Arb repeats.
:CURRent	
:CDWell	
[:LEVel] <value>{,<value>} <Block>	Specifies the level of each point in the Arb.
:DWELl <value>	Specifies the dwell time of each point in the Arb.
:POINts?	Returns the number of points in the Arb.
:FUNction	

## 1 Quick Reference

:TYPE CURRENT VOLTage	Specifies either a voltage or current Arb.
:TERMinate	
:LAST 0 OFF 1 ON	Selects the output setting after the Arb ends.
:VOLTage	
:CDWell	
[:LEVel] <value>{,<value>} <Block>	Specifies the level of each point in the Arb.
:DWELl <value>	Specifies the dwell time of each point in the Arb.
:POINts?	Returns the number of points in the Arb.

## [SOURce:]CURRent Subsystem

[SOURce:]

CURRent

[:LEVel]

[:IMMediate]

[:AMPLitude] <value> Sets the output current when in current priority mode

:TRIGgered

[:AMPLitude] <value> Sets the triggered output current

:LIMit

[:POSitive]

[:IMMediate]

[:AMPLitude] <value> Sets the current limit when in voltage priority mode.

:NEGative

[:IMMediate]

[:AMPLitude] <value> Sets the current limit when in voltage priority mode.

:MODE FIXed|STEP|LIST|ARB

Sets the transient mode.

:PROTection

:DELay

[:TIME] <value> Sets the over-current protection delay.

:START SChange|CCTRans Specifies what starts the over-current protection delay timer.

:STATe 0|OFF|1|ON

Enables or disables the over-current protection.

:SHARing

[:STATe] 0|OFF|1|ON

Enables or disables current sharing on paralleled units.

:SLEW

[:IMMediate] <value>|INFinity Sets the current slew rate.

:MAXimum 0|OFF|1|ON Enables or disables the maximum slew rate override.

## [SOURce:]DIGital Subsystem

[SOURce:]

DIGital

:INPut

:DATA?

Reads the state of the digital control port.

:OUTPut

:DATA <value>	Sets the state of the digital control port.
:PIN<1-7>	
:FUNction <function>	Sets the function of the pins. DIO  DINPut  EXPRession<1-8>  FAULT  INHibit  ONCouple  OFFCouple  TOUTput  TINPut
:POLarity POSitive NEGative	Sets the polarity of the pins.
:TOUTput	
:BUS	
[:ENABLE] 0 OFF 1 ON	Enables or disables BUS triggers on digital port pins.

## [SOURce:]FUNCTION Command

[SOURce:]	
:FUNction CURRent VOLTage	Sets the output regulation - voltage priority or current priority.

## [SOURce:]LIST Subsystem

[SOURce:]	
LIST	
:COUNT <value>  INFinity	Sets the list repeat count.
:CURRent	
[:LEVel] <value>{,<value>}	Specifies the setting for each list step.
:POINTs?	Returns the number of list points.
:DWEll <value>{,<value>}	Specifies the dwell time for each list step.
:POINTs?	Returns the number of list points.
:STEP ONCE AUTO	Specifies how the list responds to triggers.
:TERMinate	
:LAST 0 OFF 1 ON	Determines the output value when the list terminates.
:TOUTput	
:BOSTep	
[:DATA] <Bool>{,<Bool>}	Generates a trigger out at the Beginning Of STep
:POINTs?	Returns the number of list points.
:EOSTep	
[:DATA] <Bool>{,<Bool>}	Generates a trigger out at the End Of STep
:POINTs?	Returns the number of list points.
:VOLTage	
[:LEVel] <value>{,<value>}	Specifies the setting for each list step.
:POINTs?	Returns the number of list points.

## [SOURce:]POWER Query

[SOURce:]	
:POWER	
:LIMit?	Returns the output power limit of the instrument.

**[SOURce:]Resistance Subsystem**

```

[:SOURce]
  :RESistance
    [:LEVel]
      [:IMMediate]
        [:AMPLitude] <value> Sets the output resistance level.
      :STATe 0|OFF|1|ON      Enables or disables output resistance programming.

```

**[SOURce:]STEP Command**

```

[SOURce:]
  :STEP
    :TOUTput0|OFF|1|ON Specifies whether a trigger out is generated when a transient step occurs.

```

**[SOURce:]VOLTage Subsystem**

```

[SOURce:]
  VOLTage
    [:LEVel]
      [:IMMediate]
        [:AMPLitude] <value> Sets the output voltage when in voltage priority mode.
      :TRIGgered
        [:AMPLitude] <value> Sets the triggered output voltage.
      :BWIDTH LOW|HIGH1      Sets the voltage bandwidth. (for backward compatibility)
      :LEVel 0|1, <value>    Sets the programming pole frequency.
      :RANGe 0|1             Sets the voltage bandwidth.
      :LIMit
        [:POSitive]
          [:IMMediate]
            [:AMPLitude] <value> Sets the voltage limit when in current priority mode.
      :MODE FIXed|STEP|LIST|ARB Sets the transient mode.
      :PROTection
        [:LEVel] <value>     Sets the over-voltage protection level.
      :RESistance
        [:LEVel]
          [:IMMediate]
            [:AMPLitude] <value> Sets the output resistance when in voltage priority mode.
      :STATe 0|OFF|1|ON      Enables or disables resistance programming in voltage priority mode.
      :SLEW
        [:IMMediate] <value>|INFINITY Sets the voltage slew rate.
        :MAXimum 0|OFF|1|ON      Enables or disables the maximum slew rate override.

```

## STATus Subsystem

### STATus

:OPERation	
[:EVENT]?	Queries the operation event register.
:CONDition?	Queries the operation condition register.
:ENABle <value>	Sets the operation enable register.
:NTRansiton <value>	Sets the Negative transition filter
:PTRansiton <value>	Sets the Positive transition filter
:USER<1 2>	
:SOURce EXPReSSion<1-8> NONE	Selects an expression to drive the user-defined status bits.
:PRESet	Presets all Enable, PTR, and NTR registers.
:QUESTionable<1 2>	
[:EVENT]?	Queries the questionable event register.
:CONDition?	Queries the questionable condition register.
:ENABle <value>	Sets the questionable enable register.
:NTRansiton <value>	Sets the Negative transition filter
:PTRansiton <value>	Sets the Positive transition filter

## SYSTem Subsystem

### SYSTem

:BBR	
:EVENT <"string">	Adds an event string into the BBR event log.
:SNAPshot <value>	Captures a data snapshot of the specified length.
:STATus?	Returns the completion status of the snapshot in percent.
:STATE?	Returns true (1) if the Black Box Recorder is logging.
:TIME?	Returns the length of the Black Box Recorder data.
:COMMunicate	
:LAN TCPIP:CONTRol?	Returns the initial socket control connection port number.
:RLState LOCAL REMOte RWLock	Configures the remote/local state of the instrument.
:DATE <yyyy>,<mm>,<dd>	Sets the date of the system clock.
:ERRor?	Reads and clears one error from the error queue.
:LFRequency?	Returns the power-line reference frequency.
:LFRequency	
:MODE AUTO MAN50 MAN60	Specifies automatic or manual line frequency detection.
:PASSword	
:FPANel	
:RESet	Resets the front panel lockout password to zero.
:REBoot	Reboots the instrument to its power-on state.
:SECurity	
:IMMEDIATE	Clears all user memory and reboots the instrument.
:SIGNal	

## 1 Quick Reference

:DEFine EXPResion<1-8>, <"expression">	Defines up to eight signal expressions.
:TEMPerature	
:AMBient?	Returns the temperature at the air inlet.
:TIME <hh>,<mm>,<ss>	Sets the time of the system clock.
:VERSion?	Returns the SCPI version that the instrument complies with.

## TRIGger Subsystem

### TRIGger

:ACQuire	
[:IMMediate]	Generates an immediate trigger.
:CURRent	
[:LEVel] <value>	Sets the triggered level of the output.
:SLOPe POSitive NEGative	Sets the slope of the signal.
:INDices	
[:DATA]?	Returns the indices where triggers were captured.
:COUNT?	Returns the number of triggers captured during the acquisition.
:SOURce <source>	Selects the trigger source for the acquisition system: BUS  CURRent1  EXTernal  EXPResion<1-8>  PIN<1-7>  TRANSient1  VOLTage1
:TOUTput	
[:ENABle] 0 OFF 1 ON	Enables measurement triggers to be sent to a digital port pin.
:VOLTage	
[:LEVel] <value>	Sets the triggered level of the output.
:SLOPe POSitive NEGative	Sets the slope of the signal.
:ARB	
:SOURce <source>	Selects the trigger source for arbitrary waveforms: BUS  EXTernal  IMMediate  EXPResion<1-8>  PIN<1-7>
:ELOG	
[:IMMediate]	Generates an immediate trigger.
:SOURce <source>	Selects the trigger source for external data logging: BUS  EXTernal  IMMediate  PIN<1-7>
:TRANSient	
[:IMMediate]	Generates an immediate trigger.
:SOURce <source>	Selects the trigger source for the transient system: BUS  EXTernal  IMMediate  EXPResion<1-8>  PIN<1-7>

## Model Features and Options

### Model Features

Feature	Keysight N6900 models		Keysight N7900 dynamic models	
	● = included	1 kW	2 kW	1 kW
Voltage/Current Ratings	N6950A 9 V/100 A N6951A 20 V/50 A N6952A 40 V/25 A N6953A 60V/16.7A N6954A 80V/12.5A	N6970A 9 V/200 A N6971A 20V/100 A N6972A 40 V/50 A N6973A 60 V/33.3 A N6974A 80 V/25 A N6976A 120V/16.7A N6977A 160V/12.5A	N7950A 9 V/100 A N7951A 20 V/50 A N7952A 40 V/25 A N7953A 60V/16.7A N7954A 80V/12.5A	N7970A 9 V/200 A N7971A 20V/100 A N7972A 40 V/50 A N7973A 60 V/33.3 A N7974A 80 V/25 A N7976A 120V/16.7A N7977A 160V/12.5A
Current sinking up to 100% of rated current	Requires one N7909A power dissipator	Requires two N7909A power dissipators <sup>1</sup>	Requires one N7909A power dissipator	Requires two N7909A power dissipators <sup>1</sup>
Current sinking up to 10% of rated current	●	●	●	●
Disconnect relays <sup>2</sup>	Option 760 <sup>3</sup> Option 761	Option 760 <sup>3</sup> Option 761 <sup>4</sup>	N7950A <sup>3</sup> N7951A-N7954A	N7970 <sup>3</sup> N7971A-N7974A N7976A, N7977A <sup>4</sup>
Voltage programming and measurement	0.03% accuracy + offset		0.03% accuracy + offset	
Current programming and measurement	0.1% accuracy + offset With Option 301: 0.04% accuracy + offset		0.04% accuracy + offset	
Parallel operation		●		●
Status signal routing		●		●
Programmable output resistance		●		●
Power measurements		●		●
Amp-Hour and Watt-Hour Measurements		●		●
Low current measurement range		Option 301		●
Seamless current measurements		Option 301		●
Adjustable sample rate		Option 301		●
Array readback		Option 302		●
External data logging		Option 302		●

## 1 Quick Reference

Feature	Keysight N6900 models		Keysight N7900 dynamic models		
	● = included	1 kW	2 kW	1 kW	2 kW
Faster programming		Option 303		●	
Output lists		Option 303		●	
Arbitrary wavedforms		Option 303		●	
Black box recorder		Option BBR			Option BBR

<sup>1</sup> 2 kW models with one power dissipator can sink 50% of their rated current.

<sup>2</sup> An **AC network** is always present across the output terminals.

<sup>3</sup> Polarity reverse relays (in Option 760) are not available on models N6950A, N6970A, N7950A, and N7970A.

<sup>4</sup> Models N6976A Opt 760, N6977A Opt 760, N7976A, and N7977A include solid state disconnect relays in addition to galvanic disconnect relays for faster protection disconnect.

## Accessories/Options

Accessory/ Option Number	Description
Keysight N7909A	1 kW power dissipator. 1 unit is required for 1 kW power supplies to sink the rated power; 2 units are required for 2 kW power supplies to sink the rated power.
Keysight N7908A	Black Box Recorder board - Only available on units with serial numbers prior to MY59100101. Installs in an access port on the bottom of the unit. When installed, appears as Option BBR in the "About" screen and must be check-marked on the unit label under "Black Box Recorder".
Keysight N7910A	Rack Ear and Slide Accessory Kit - everything needed for mounting 1 kW models, 2 kW models, and the power dissipator in 19-inch EIA cabinets.
N6700-60012	1U Rack ears only - for 1 kW models and the power dissipator (1.75 in. high)
5063-9212	2U Rack ears only - for 2 kW models (3.5 in. high)
5063-9219	2U Rack ears with handles - for 2 kW models (3.5 in. high)
5003-1128	Rack slides only - for mounting 1 kW models, 2 kW models, and the power dissipator in 19-inch EIA cabinets.
Keysight E664AC	Rails only - for mounting 2 kW models in 19 inch EIA cabinets. Because of required airflow, you <b>cannot</b> use rails for mounting 1 kW models or the power dissipator.
Option 301	Improves the programming and measurement accuracy, and adds a seamless low-current measurement range. This option is included on all N7900 models.
Option 302	Adds voltage and current digitizers with programmable sample rates and external data logging. This option is included on all N7900 models.
Option 303	Adds output list, arbitrary waveform, and voltage compensation pole frequency capability. Also adds 6x improvement in up/down programming times. This option is included on all N7900 models.
Option 760	Disconnect relays including polarity reverse relays. Appears as option 760 in the "About" screen and on the unit label. This option is NOT available for Models N6950A and N6970A, and is NOT included on Models N7950A and N7970A.
Option 761	Disconnect relays without polarity reverse. Appears as option 761 in the "About" screen and on the unit label. This option is available for Models N6950A and N6970A, and is included on Models N7950A and N7970A.
Option UK6	Commercial calibration with test results data.
Option BBR	Black Box Recorder. Only available on units with serial numbers MY59100101 and later. Previously available as Keysight N7908A
PathWave BenchVue BV9200B & BV9201B	Advanced Power Control and Analysis Software

## Specifications and Characteristics

[Specifications - Keysight N6900 Series](#)

[Specifications - Keysight N7900 Series](#)

[Specifications - Keysight N6900/N7900 High Voltage Series](#)

[Supplemental Characteristics - Keysight N6900 Series](#)

[Supplemental Characteristics - Keysight N7900 Series](#)

[Supplemental Characteristics - Keysight N6900/N7900 High Voltage Series](#)

[Common Characteristics](#)

[Output Impedance Graphs](#)

[Inductive Load Boundary](#)

[Output Quadrants](#)

[Voltage Programming Response](#)

[Output Dynamic Response](#)

[Measurement Accuracy and Resolution](#)

[Dimension Diagrams](#)

## Introduction

Unless otherwise noted, specifications are warranted over the ambient temperature range of 0 to 40°C after a 30-minute warm-up period. Specifications apply at the output terminals, with the sense terminals connected to the output terminals (local sensing). Accuracy specifications are warranted for one year.

Supplemental characteristics are not warranted but are descriptions of performance determined either by design or by type testing. All supplemental characteristics are typical unless otherwise noted.

## Specifications - Keysight N6900 Series

1 kW Specifications	N6950A	N6951A	N6952A	N6953A	N6954A
DC Ratings					
Voltage source:	0 to 9 V	0 to 20 V	0 to 40 V	0 to 60 V	0 to 80 V
Current source:	0 to 100 A	0 to 50 A	0 to 25 A	0 to 16.7 A	0 to 12.5 A
Current sink 10% rating:	-10 A	-5 A	-2.5 A	-1.67 A	-1.25 A
Current sink 100% rating: <sup>1</sup>	-100 A	-50 A	-25 A	-16.7 A	-12.5 A
Power: <sup>2</sup>	900 W	1 kW	1 kW	1 kW	1 kW
Output ripple & noise <sup>3</sup>					
CV rms:			1 mV		
CV peak-to-peak:			9 mV		
Load regulation					
Voltage:	0.5 mV	0.75 mV	1.5 mV	2 mV	2 mV
Current:	8 mA	3 mA	1 mA	1 mA	0.8 mA
Voltage programming & measurement accuracy <sup>4, 5, 6</sup>					
Lead drop $\leq 1$ V max:	0.03% +1.5 mV	0.03% +3 mV	0.03% +6 mV	0.03% +9 mV	0.03% +12 mV
Lead drop $\leq 25\%$ of V rating:	0.03% +1.9 mV	0.03% +4 mV	0.03% +7.9 mV	0.03% +12 mV	0.03% +16 mV
<b>N6900 Opt 301</b>					
Lead drop $\leq 1$ V max:	0.03% +1 mV	0.03% +2 mV	0.03% +4 mV	0.03% +6 mV	0.03% +8 mV
Lead drop $\leq 25\%$ of V rating:	0.03% +1.4 mV	0.03% +3 mV	0.03% +5.9 mV	0.03% +9 mV	0.03% +12 mV
Current programming & measurement accuracy: <sup>4</sup>					
<b>N6900 Opt 301</b> Accuracy:	0.1% +30 mA	0.1% +15 mA	0.1% +8 mA	0.1% +5 mA	0.1% +4 mA
	0.04% +15 mA	0.04% +8 mA	0.04% +4 mA	0.04% +2.5 mA	0.04% +2 mA
<b>N6900 Opt 301</b> Current low range					
measurement accuracy:	0.05% +3 mA	0.05% +1 mA	0.05% +0.6 mA	0.05% +0.3 mA	0.05% +0.25 mA
Transient response <sup>7</sup>					
Recovery Time:	100 $\mu$ s	100 $\mu$ s	100 $\mu$ s	100 $\mu$ s	100 $\mu$ s
Settling band:	150 mV	150 mV	100 mV	150 mV	200 mV
2 kW Specifications	N6970A	N6971A	N6972A	N6973A	N6974A
DC Ratings					
Voltage source:	0 to 9 V	0 to 20 V	0 to 40 V	0 to 60 V	0 to 80 V
Current source:	0 to 200 A	0 to 100 A	0 to 50 A	0 to 33.3 A	0 to 25 A
Current sink 10% rating:	-20 A	-10 A	-5 A	-3.33 A	-2.5 A
Current sink 100% rating: <sup>1</sup>	-200 A	-100 A	-50 A	-33.3 A	-25 A
Power: <sup>2</sup>	1.8 kW	2 kW	2 kW	2 kW	2 kW
Output ripple & noise <sup>3</sup>					
CV rms:			1 mV		
CV peak-to-peak:			9 mV		
Load regulation					
Voltage:	0.5 mV	0.75 mV	1.5 mV	2 mV	2 mV
Current:	15 mA	6 mA	1.5 mA	1.5 mA	1.5 mA

## 1 Quick Reference

2 kW Specifications	N6970A	N6971A	N6972A	N6973A	N6974A
Voltage programming & measurement accuracy <sup>4, 5, 6</sup>					
Lead drop $\leq 1$ V max:	0.03% +1.5 mV	0.03% +3 mV	0.03% +6 mV	0.03% +9 mV	0.03% +12 mV
Lead drop $\leq 25\%$ of V rating:	0.03% +1.9 mV	0.03% +4 mV	0.03% +7.9 mV	0.03% +12 mV	0.03% +16 mV
<b>N6900 Opt 301</b>					
Lead drop $\leq 1$ V max:	0.03% +1 mV	0.03% +2 mV	0.03% +4 mV	0.03% +6 mV	0.03% +8 mV
Lead drop $\leq 25\%$ of V rating:	0.03% +1.4 mV	0.03% +3 mV	0.03% +5.9 mV	0.03% +9 mV	0.03% +12 mV
Current programming & measurement accuracy <sup>4</sup>	0.1% +60 mA	0.1% +30 mA	0.1% +15 mA	0.1% +10 mA	0.1% +8 mA
<b>N6900 Opt 301</b> accuracy:	0.04% +30 mA	0.04% +15 mA	0.04% +8 mA	0.04% +5 mA	0.04% +4 mA
<b>N6900 Opt 301</b> Current low range measurement accuracy:	0.05% +6 mA	0.05% +2 mA	0.05% +1.2 mA	0.05% +0.6 mA	0.05% +0.5 mA
Transient response <sup>7</sup>					
Recovery Time:	100 $\mu$ s	100 $\mu$ s	100 $\mu$ s	100 $\mu$ s	100 $\mu$ s
Settling band:	150 mV	150 mV	100 mV	150 mV	200 mV

<sup>1</sup> Current sinking up to 100% of rated current requires one power dissipator for 1 kW models, and two power dissipators for 2 kW models. 2 kW models with one power dissipator can sink 50% of their rated current.

<sup>2</sup> Maximum continuous power available is derated at 1% of rating per degree C from 40°C to 55°C

<sup>3</sup> From 20 Hz to 300 kHz for rms noise; from 20 Hz to 20 MHz for peak-to-peak noise

<sup>4</sup> At 23°C  $\pm 5^\circ$ C after a 30 minute warm-up; measurement NPLC=1; valid for 1 year, see [Calibration Interval](#)

<sup>5</sup> With resistance programming enabled, the voltage programming offset component increases by a factor of 2.1

<sup>6</sup> Load lead drop applies to each load lead

<sup>7</sup> Time to recover to within the settling band following a load change from 50% to 100% of full load (10  $\mu$ s rise time)

## Specifications - Keysight N7900 Series

1 kW Specifications	N7950A	N7951A	N7952A	N7953A	N7954A
DC Ratings					
Voltage source:	0 to 9 V	0 to 20 V	0 to 40 V	0 to 60 V	0 to 80 V
Current source:	0 to 100 A	0 to 50 A	0 to 25 A	0 to 16.7 A	0 to 12.5 A
Current sink 10% rating:	-10 A	-5 A	-2.5 A	-1.67 A	-1.25 A
Current sink 100% rating: <sup>1</sup>	-100 A	-50 A	-25 A	-16.7 A	-12.5 A
Power: <sup>2</sup>	900 W	1 kW	1 kW	1 kW	1 kW
Output ripple & noise <sup>3</sup>					
CV rms:			1 mV		
CV peak-to-peak:			9 mV		
Load regulation					
Voltage:	0.5 mV	0.75 mV	1.5 mV	2 mV	2 mV
Current:	8 mA	3 mA	1 mA	1 mA	0.8 mA
Voltage programming & measurement accuracy <sup>4, 5, 6</sup>					
Lead drop $\leq 1$ V max:	0.03% +1 mV	0.03% +2 mV	0.03% +4 mV	0.03% +6 mV	0.03% +8 mV
Lead drop $\leq 25\%$ of V rating:	0.03% +1.4 mV	0.03% +3 mV	0.03% +5.9 mV	0.03% +9 mV	0.03% +12 mV

1 kW Specifications	N7950A	N7951A	N7952A	N7953A	N7954A
Current programming & measurement accuracy: <sup>4</sup>	0.04% +15 mA	0.04% +8 mA	0.04% +4 mA	0.04%+2.5 mA	0.04% +2 mA
Current low range measurement accuracy:	0.05% +3 mA	0.05% +1 mA	0.05% +0.6 mA	0.05% +0.3 mA	0.05% +0.25mA
Transient response <sup>7</sup>					
Recovery Time:	100 $\mu$ s	100 $\mu$ s	100 $\mu$ s	100 $\mu$ s	100 $\mu$ s
Settling band:	150 mV	150 mV	100 mV	150 mV	200 mV
2 kW Specifications	N7970A	N7971A	N7972A	N7973A	N7974A
DC Ratings					
Voltage source:	0 to 9 V	0 to 20 V	0 to 40 V	0 to 60 V	0 to 80 V
Current source:	0 to 200 A	0 to 100 A	0 to 50 A	0 to 33.3 A	0 to 25A
Current sink 10% rating:	-20 A	-10 A	-5 A	-3.33 A	-2.5 A
Current sink 100% rating: <sup>1</sup>	-200 A	-100 A	-50 A	-33.3 A	-25 A
Power: <sup>2</sup>	1.8 kW	2 kW	2 kW	2 kW	2 kW
Output ripple & noise <sup>3</sup>					
CV rms:			1 mV		
CV peak-to-peak:			9 mV		
Load regulation					
Voltage:	0.5 mV	0.75 mV	1.5 mV	2 mV	2 mV
Current:	15 mA	6 mA	1.5 mA	1.5 mA	1.5 mA
Voltage programming & measurement accuracy <sup>4, 5, 6</sup>					
Lead drop $\leq$ 1 V max:	0.03% +1 mV	0.03% +2 mV	0.03% +4 mV	0.03% +6 mV	0.03% +8 mV
Lead drop $\leq$ 25% of V rating:	0.03% +1.4 mV	0.03% +3 mV	0.03% +5.9mV	0.03% +9 mV	0.03% +12mV
Current programming & measurement accuracy: <sup>4</sup>	0.04% +30 mA	0.04% +15 mA	0.04% +8 mA	0.04% +5 mA	0.04% +4 mA
Current low range measurement accuracy:	0.05% +6 mA	0.05% +2 mA	0.05% +1.2 mA	0.05% +0.6 mA	0.05% +0.5 mA
Transient response <sup>7</sup>					
Recovery Time:	100 $\mu$ s	100 $\mu$ s	100 $\mu$ s	100 $\mu$ s	100 $\mu$ s
Settling band:	150 mV	150 mV	100 mV	150 mV	200 mV

<sup>1</sup> Current sinking up to 100% of rated current requires one power dissipator for 1 kW models, and two power dissipators for 2 kW models. 2 kW models with one power dissipator can sink 50% of their rated current.

<sup>2</sup> Maximum continuous power available is derated at 1% of rating per degree C from 40°C to 55°C

<sup>3</sup> From 20 Hz to 300 kHz for rms noise; from 20 Hz to 20 MHz for peak-to-peak noise

<sup>4</sup> At 23°C  $\pm$ 5°C after a 30 minute warm-up; measurement NPLC=1; valid for 1 year, see [Calibration Interval](#)

<sup>5</sup> With resistance programming enabled, the voltage programming offset component increases by a factor of 3.15

<sup>6</sup> Load lead drop applies to each load lead

<sup>7</sup> Time to recover to within the settling band following a load change from 50% to 100% of full load (10  $\mu$ s rise time)

## Specifications - Keysight N6900/N7900 High Voltage Series

2 kW Specifications	N6976A	N6977A	N7976A	N7977A
DC Ratings				
Voltage source:	0 to 120 V	0 to 160 V	0 to 120 V	0 to 160 V
Current source:	0 to 16.7 A	0 to 12.5 A	0 to 16.7 A	0 to 12.5 A
Current sink 10% rating:	-1.67 A	-1.25 A	-1.67 A	-1.25 A
Current sink 100% rating: <sup>1</sup>	-16.7 A	-12.5 A	-16.7 A	-12.5 A
Power: <sup>2</sup>	2 kW	2 kW	2 kW	2 kW
Output ripple & noise <sup>3</sup>				
CV rms:	2 mV	3 mV	2 mV	3 mV
CV peak-to-peak:	30 mV	30 mV	30 mV	30 mV
Load regulation				
Voltage:	4 mV	4 mV	4 mV	4 mV
Current:	1 mA	0.8 mA	1 mA	0.8 mA
Voltage programming & measurement accuracy <sup>4, 5, 6</sup>				
Lead drop $\leq 1$ V max:	0.03% +17 mV	0.03% +24 mV	0.03% +11 mV	0.03% +14 mV
Lead drop $\leq 25\%$ of V rating:	0.03% +23 mV	0.03% +32 mV	0.03% +17 mV	0.03% +22 mV
<b>N6900 Opt 301</b>				
Lead drop $\leq 1$ V max:	0.03% +11 mV	0.03% +14 mV		
Lead drop $\leq 25\%$ of V rating:	0.03% +17 mV	0.03% +22 mV		
Current programming & measurement accuracy: <sup>4</sup>				
<b>N6900 Opt 301</b> accuracy:	0.1% +5 mA	0.1% +4 mA	0.04% +2.5 mA	0.04% +2 mA
	0.04% +2.5 mA	0.04% +2 mA		
Current low range measurement accuracy:				
<b>N6900 Opt 301</b> accuracy:	N/A	N/A	0.05% +0.4 mA	0.05% +0.25 mA
	0.05% +0.4 mA	0.05% +0.25 mA		
Transient response <sup>7</sup>				
Recovery Time:	100 $\mu$ s	100 $\mu$ s	100 $\mu$ s	100 $\mu$ s
Settling band:	300 mV	400 mV	300 mV	400 mV

<sup>1</sup>Two power dissipators required to sink up to 100% of rated current; one power dissipator sinks up to 50% of rated current.

<sup>2</sup>Maximum continuous power available is derated at 1% of rating per degree C from 40°C to 55°C

<sup>3</sup>From 20 Hz to 300 kHz for rms noise; from 20 Hz to 20 MHz for peak-to-peak noise

<sup>4</sup>At 23°C  $\pm 5^\circ$ C after a 30 minute warm-up; measurement NPLC=1; valid for 1 year, see **Calibration Interval**

<sup>5</sup>With resistance programming enabled, the voltage programming offset component increases by a factor of 2.1

<sup>6</sup>Load lead drop applies to each load lead

<sup>7</sup>Time to recover to within the settling band following a load change from 50% to 100% of full load (10  $\mu$ s rise time)

## Supplemental Characteristics - Keysight N6900 Series

1 kW Characteristics	N6950A	N6951A	N6952A	N6953A	N6954A
Minimum compliance limits					
Voltage priority:	100 mA	50 mA	25 mA	16 mA	13 mA
Current priority:	9 mV	20 mV	40 mV	60 mV	80 mV
Voltage programming					
Range:	0.009 to 9.18 V	0.02 to 20.4 V	0.04 to 40.8 V	0.06 to 61.2 V	0.08 to 81.6 V
Resolution:	0.84 mV	1.7 mV	3.5 mV	5 mV	6.7 mV
<b>N6900 Opt 301</b> Resolution:	0.21 mV	0.42 mV	0.84 mV	1.25 mV	1.68 mV
Current programming					
Range-no dissipator:	-10.2 to 102 A	-5.1 to 51 A	-2.55 to 25.5 A	-1.7 to 17.034A	-1.275 to 12.75 A
Range-with dissipator:	-102 to 102 A	-51 to 51 A	-25.5 to 25.5 A	-17.034 to 17.034A	-12.75 to 12.75 A
Resolution:	30 mA	15 mA	8 mA	5 mA	4 mA
<b>N6900 Opt 301</b> Resolution:	1.9 mA	0.95 mA	0.47 mA	0.32 mA	0.24 mA
Current measurement range					
High range:	-225 to 225 A	-112.5 to 112.5 A	-56.2 to 56.2 A	-37.6 to 37.6 A	-28.1 to 28.1 A
<b>N6900 Opt 301</b> Low range:	-11 to 11 A	-5.5 to 5.5 A	-2.75 to 2.75 A	-1.84 to 1.84 A	-1.37 to 1.37 A
Resistance programming					
Range:	0 to 0.1 $\Omega$	0 to 0.4 $\Omega$	0 to 1.6 $\Omega$	0 to 3.4 $\Omega$	0 to 6.4 $\Omega$
Resolution:	0.8 $\mu\Omega$	3.4 $\mu\Omega$	13 $\mu\Omega$	30 $\mu\Omega$	54 $\mu\Omega$
Accuracy: <sup>1</sup>	0.12% +1.6 m $\Omega$ *A	0.12% +3.2 m $\Omega$ *A	0.1% +6.4 m $\Omega$ *A	0.1% +8.8 m $\Omega$ *A	0.1% +12.8 m $\Omega$ *A
<b>N6900 Opt 301</b> Accuracy:	0.06% +1.6 m $\Omega$ *A	0.06% +1.6 m $\Omega$ *A	0.06% +1.6 m $\Omega$ *A	0.06% +1.6 m $\Omega$ *A	0.06% +1.6 m $\Omega$ *A
Voltage programming & measurement TempCo: <sup>2</sup>					
	0.0022% +30 $\mu$ V	0.0022%+60 $\mu$ V	0.0022%+120 $\mu$ V	0.0022%+180 $\mu$ V	0.0022%+220 $\mu$ V
Current programming & measurement TempCo <sup>2</sup>					
High range:	0.0057%+250 $\mu$ A	0.0058%+125 $\mu$ A	>0.0058%+60 $\mu$ A	0.0058%+40 $\mu$ A	0.0058%+30 $\mu$ A
<b>N6900 Opt 301</b> High range:	0.0035%+250 $\mu$ A	0.0035%+125 $\mu$ A	0.0042%+60 $\mu$ A	0.0037%+40 $\mu$ A	0.0036%+30 $\mu$ A
<b>N6900 Opt 301</b> Low range:	0.0042%+80 $\mu$ A	0.0045%+40 $\mu$ A	0.0050%+20 $\mu$ A	0.0046%+12 $\mu$ A	0.0045%+9 $\mu$ A
Resistance programming					
TempCo:	0.0068%	0.0070%	0.0070%	0.0070%	0.0070%
<b>N6900 Opt 301</b> TempCo:	0.0046%	0.0049%	0.0054%	0.0050%	0.0049%
Over-Voltage Protection					
Maximum setting:	10.8 V	24 V	48 V	72 V	96 V
Response time: <sup>3</sup>	<30 $\mu$ s	<30 $\mu$ s	<30 $\mu$ s	<30 $\mu$ s	<30 $\mu$ s
Accuracy:	0.03% +1.5 mV	0.03% +3 mV	0.03% +6 mV	0.03% +9 mV	0.03% +12 mV
<b>N6900 Opt 301</b> Accuracy:	0.03% +1 mV	0.03% +2 mV>	0.03% +4 mV	0.03% +6 mV	0.03% +8 mV
Voltage measurement noise (peak): <sup>4</sup>					
	2 mV	3.5 mV	7 mV	10 mV	14 mV
Current measurement noise (peak) <sup>4</sup>					
High range:	45 mA	22 mA	10 mA	6 mA	4 mA
<b>N6900 Opt 301</b> Low range:	30 mA	17 mA	7 mA	4 mA	2 mA

## 1 Quick Reference

1 kW Characteristics	N6950A	N6951A	N6952A	N6953A	N6954A
Output current noise <sup>5</sup> CC rms:	15 mA	15 mA	15 mA	15 mA	15 mA
Common mode current <sup>5</sup> CC rms: CC peak-to-peak:	2 mA 10 mA	1 mA 10 mA	1 mA 10 mA	1 mA 10 mA	1.5 mA 10 mA
Voltage up-programming time <sup>6</sup> 10% to 90%: Settling time: <sup>8</sup> <b>N6900 Opt 303</b> 10% to 90%: Settling time: <sup>8</sup>			3 ms 10 ms  0.5 ms 1 ms		
Voltage down-programming time <sup>7</sup> 90% to 10%: Settling time: <sup>8</sup> <b>N6900 Opt 303</b> 90% to 10%: Settling time: <sup>8</sup>			3 ms 10 ms  0.35 ms 0.8 ms		
Current up- and down-programming time <sup>9</sup> 10% to 90%: 90% to 10%:			2.5 ms 2.5 ms		
Output-on delay time Voltage priority: Current priority:			12 ms (38 ms with Relay Option on) 14 ms (46 ms with Relay Option on)		
Line regulation Voltage: Current:			< 10 $\mu$ V < 10 $\mu$ A		
<b>N6900 Opt 303</b> Small signal bandwidth Voltage programming: <sup>10</sup> Current programming: <sup>11</sup> Voltage measurement: Current measurement:			DC to 1 kHz (-1dB); DC to 2 kHz (-3dB) DC to 70 Hz (-1dB); DC to 120 Hz (-3dB) DC to 14 kHz (-1dB); DC to 25 kHz (-3dB) DC to 14 kHz (-1dB); DC to 25 kHz (-3dB)		
2 kW Characteristics	N6970A	N6971A	N6972A	N6973A	N6974A
Minimum compliance limits Voltage priority: Current priority:	200 mA 9 mV	100 mA 20 mV	50 mA 40 mV	33 mA 60 mV	26 mA 80 mV
Voltage programming Range: Resolution: <b>N6900 Opt 301</b> Resolution:	0.009 to 9.18 V 0.84 mV 0.21 mV	0.02 to 20.4 V 1.7 mV 0.42 mV	0.04 to 40.8 V 3.5 mV 0.84 mV	0.06 to 61.2 V 5 mV 1.25 mV	0.08 to 81.6 V 6.7 mV 1.68 mV

2 kW Characteristics	N6970A	N6971A	N6972A	N6973A	N6974A
Current programming					
Range-no dissipator:	-20.4 to 204 A	-10.2 to 102 A	-5.1 to 51 A	-3.4 to 33.97 A	-2.55 to 25.5 A
Range-with dissipator:	-204 to 204 A	-102 to 102 A	-51 to 51 A	-33.97 to 33.97 A	-25.5 to 25.5 A
Resolution:	60 mA	30 mA	15 mA	10 mA	8 mA
<b>N6900 Opt 301</b> Resolution:	3.8 mA	1.9 mA	0.95 mA	0.64 mA	0.48 mA
Current measurement range					
High range:	-450 to 450 A	-225 to 225 A	-112.5 to 112.5 A	-74.9 to 74.9 A	-56.2 to 56.2 A
<b>N6900 Opt 301</b> Low range:	-22 to 22 A	-11 to 11 A	-5.5 to 5.5 A	-3.67 to 3.67 A	-2.75 to 2.75 A
Resistance programming					
Range:	0 to 0.05 $\Omega$	0 to 0.2 $\Omega$	0 to 0.8 $\Omega$	0 to 1.7 $\Omega$	0 to 3.2 $\Omega$
Resolution:	0.4 $\mu\Omega$	1.7 $\mu\Omega$	7 $\mu\Omega$	15 $\mu\Omega$	27 $\mu\Omega$
Accuracy: <sup>1</sup>	0.12% +1.6 m $\Omega$ *A	0.12% +3.2 m $\Omega$ *A	0.12% +6.4 m $\Omega$ *A	0.12% +8.8 m $\Omega$ *A	0.12% +12.8 m $\Omega$ *A
<b>N6900 Opt 301</b> Accuracy:	0.06% +1.6 m $\Omega$ *A	0.06% +3.2 m $\Omega$ *A	0.06% +6.4 m $\Omega$ *A	0.06% +8.8 m $\Omega$ *A	0.06% +12.8 m $\Omega$ *A
Voltage programming & measurement TempCo: <sup>2</sup>					
	0.0022% +30 $\mu$ V	0.0022% +60 $\mu$ V	0.0022% +120 $\mu$ V	0.0022% +180 $\mu$ V	0.0022% +220 $\mu$ V
Current programming & measurement TempCo <sup>2</sup>					
High range:	0.0048% +500 $\mu$ A	0.0049% +250 $\mu$ A	0.0049% +120 $\mu$ A	0.0049% +80 $\mu$ A	0.0049% +60 $\mu$ A
<b>N6900 Opt 301</b> High range:	0.0029% +500 $\mu$ A	0.0031% +250 $\mu$ A	0.0035% +120 $\mu$ A	0.0032% +80 $\mu$ A	0.0032% +60 $\mu$ A
<b>N6900 Opt 301</b> Low range:	0.0040% +160 $\mu$ A	0.0041% +80 $\mu$ A	0.0045% +40 $\mu$ A	0.0042% +24 $\mu$ A	0.0041% +18 $\mu$ A
Resistance programming					
TempCo:	0.0060%	0.0060%	0.0060%	0.0060%	0.0060%
<b>N6900 Opt 301</b> TempCo:	0.0043%	0.0045%	0.0049%	0.0046%	0.0045%
Over-Voltage Protection					
Maximum setting:	10.8 V	24 V	48 V	72 V	96 V
Response time: <sup>3</sup>	<30 $\mu$ s	<30 $\mu$ s	<30 $\mu$ s	<30 $\mu$ s	<30 $\mu$ s
Accuracy:	0.03% +1.5 mV	0.03% +3 mV	0.03% +6 mV	0.03% +9 mV	0.03% +12 mV
<b>N6900 Opt 301</b> Accuracy:	0.03% +1 mV	0.03% +2 mV	0.03% +4 mV	0.03% +6 mV	0.03% +8 mV
Voltage measurement noise (peak): <sup>4</sup>					
	2 mV	3.5 mV	7 mV	10 mV	14 mV
Current measurement noise (peak) <sup>4</sup>					
High range:	75 mA	45 mA	18 mA	12 mA	7 mA
<b>N6900 Opt 301</b> Low range:	50 mA	30 mA	12 mA	6 mA	3 mA
Output current noise <sup>5</sup>					
CC rms:	20 mA	20 mA	15 mA	15 mA	15 mA
Common mode current <sup>5</sup>					
CC rms:	2 mA	1 mA	1 mA	1 mA	2 mA
CC peak-to-peak:	15 mA	10 mA	10 mA	10 mA	10 mA

## 1 Quick Reference

2 kW Characteristics	N6970A	N6971A	N6972A	N6973A	N6974A
Voltage up-programming time <sup>6</sup>					
10% to 90%:			3 ms		
Settling time: <sup>8</sup>			10 ms		
<b>N6900 Opt 303</b>					
10% to 90%:			0.5 ms		
Settling time: <sup>8</sup>			1 ms		
Voltage down-programming time <sup>7</sup>					
90% to 10%:			3 ms		
Settling time: <sup>8</sup>			10 ms		
<b>N6900 Opt 303</b>					
90% to 10%:			0.35 ms		
Settling time: <sup>8</sup>			0.8 ms		
Current up- and down-programming time <sup>9</sup>					
10% to 90%:			2.5 ms		
90% to 10%:			2.5 ms		
Output-on delay time					
Voltage priority:					12 ms (38 ms with Relay Option on)
Current priority:					14 ms (46 ms with Relay Option on)
Line regulation					
Voltage:					< 10 μV
Current:					< 10 μA
<b>N6900 Opt 303</b>					
Small signal bandwidth					
Voltage programming: <sup>10</sup>					DC to 1 kHz (-1dB); DC to 2 kHz (-3dB)
Current programming: <sup>11</sup>					DC to 70 Hz (-1dB); DC to 120 Hz (-3dB)
Voltage measurement:					DC to 14 kHz (-1dB); DC to 25 kHz (-3dB)
Current measurement:					DC to 14 kHz (-1dB); DC to 25 kHz (-3dB)

<sup>1</sup> Resistance programming accuracy varies with output current. For example, for an N7970A unit at 0.1Ω with a 50A transient, accuracy is:  $(0.1\Omega * 0.06\%) + (1.6m\Omega * A/50A) = 92 \mu\Omega$ .

<sup>2</sup> Per degree C

<sup>3</sup> From occurrence of over-voltage to start of shutdown

<sup>4</sup> With single point averaging

<sup>5</sup> From 20 Hz to 300 kHz for rms noise; from 20 Hz to 20 MHz for peak-to-peak noise

<sup>6</sup> With full resistive load and a voltage transition from 0.1% to 100% of rated output

<sup>7</sup> With no load and a voltage transition from 100% to 0.1% of rated output

<sup>8</sup> From start of voltage change to within 0.1% of final full scale value

<sup>9</sup> With full resistive load and a current transition from 0.1% to 100% or 100% to 0.1% of rated output

<sup>10</sup> With High Bandwidth setting, no load condition (see [Voltage Programming Response](#))

<sup>11</sup> With resistive load condition

## Supplemental Characteristics - Keysight N7900 Series

1 kW Characteristics	N7950A	N7951A	N7952A	N7953A	N7954A1
Minimum compliance limits					
Voltage priority:	100 mA	50 mA	25 mA	16 mA	13 mA
Current priority:	9 mV	20 mV	40 mV	60 mV	80 mV
Voltage programming					
Range:	0.009 to 9.18 V	0.02 to 20.4 V	0.04 to 40.8 V	0.06 to 61.2 V	0.08 to 81.6 V
Resolution:	0.21 mV	0.42 mV	0.84 mV	1.25 mV	1.68 mV
Current programming					
Range-no dissipator:	-10.2 to 102 A	-5.1 to 51 A	-2.55 to 25.5 A	-1.7 to 17.034A	-1.275 to 12.75 A
Range-with dissipator:	-102 to 102 A	-51 to 51 A	-25.5 to 25.5 A	-17.034 to 17.034A	-12.75 to 12.75 A
Resolution:	1.9 mA	0.95 mA	0.47 mA	0.32 mA	0.24 mA
Current measurement range					
High range:	-225 to 225 A	-112.5 to 112.5 A	-56.2 to 56.2 A	-37.6 to 37.6 A	-28.1 to 28.1 A
Low range:	-11 to 11 A	-5.5 to 5.5 A	-2.75 to 2.75 A	-1.84 to 1.84 A	-1.37 to 1.37 A
Resistance programming					
Range:	0 to 0.1 $\Omega$	0 to 0.4 $\Omega$	0 to 1.6 $\Omega$	0 to 3.4 $\Omega$	0 to 6.4 $\Omega$
Resolution:	0.8 $\mu\Omega$	3.4 $\mu\Omega$	13 $\mu\Omega$	30 $\mu\Omega$	54 $\mu\Omega$
Accuracy: <sup>1</sup>	0.06% +1.6 m $\Omega$ *A	0.06% +3.2 m $\Omega$ *A	0.06% +6.4 m $\Omega$ *A	0.06% +8.8 m $\Omega$ *A	0.06% +12.8 m $\Omega$ *A
Voltage programming & measurement TempCo: <sup>2</sup>					
	0.0022% +30 $\mu$ V	0.0022%+60 $\mu$ V	0.0022%+120 $\mu$ V	0.0022%+180 $\mu$ V	0.0022%+220 $\mu$ V
Current programming & measurement TempCo <sup>2</sup>					
High range:	0.0035%+250 $\mu$ A	0.0035%+125 $\mu$ A	0.0042%+60 $\mu$ A	0.0037%+40 $\mu$ A	0.0036%+30 $\mu$ A
Low range:	0.0042%+80 $\mu$ A	0.0045%+40 $\mu$ A	0.0050%+20 $\mu$ A	0.0046%+12 $\mu$ A	0.0045%+9 $\mu$ A
Resistance programming TempCo:					
	0.0046%	0.0049%	0.0054%	0.0050%	0.0049%
Over-Voltage Protection					
Maximum setting:	10.8 V	24 V	48 V	72 V	96 V
Response time: <sup>3</sup>	<30 $\mu$ s	<30 $\mu$ s	<30 $\mu$ s	<30 $\mu$ s	<30 $\mu$ s
Accuracy:	0.03% +1 mV	0.03% +2 mV	0.03% +4 mV	0.03% +6 mV	0.03% +8 mV
Voltage measurement noise (peak): <sup>4</sup>					
	2 mV	3.5 mV	7 mV	10 mV	14 mV
Current measurement noise (peak) <sup>4</sup>					
High range:	45 mA	22 mA	10 mA	6 mA	4 mA
Low range:	30 mA	17 mA	7 mA	4 mA	2 mA
Output current noise <sup>5</sup>					
CC rms:	15 mA	15 mA	15 mA	15 mA	15 mA
Common mode current <sup>5</sup>					
CC rms:	2 mA	1 mA	1 mA	1 mA	1.5 mA
CC peak-to-peak:	10 mA	10 mA	10 mA	10 mA	10 mA

## 1 Quick Reference

1 kW Characteristics	N7950A	N7951A	N7952A	N7953A	N7954A1
Voltage up-programming time <sup>6</sup> 10% to 90%: Settling time: <sup>8</sup>			0.5 ms 1 ms		
Voltage down-programming time <sup>7</sup> 90% to 10%: Settling time: <sup>8</sup>			0.35 ms 0.8 ms		
Current up- and down-programming time <sup>9</sup> 10% to 90%: 90% to 10%:			2.5 ms 2.5 ms		
Output-on delay time Voltage priority: with Relay Option on: Current priority: with Relay Option on:			12 ms 38 ms 14 ms 46 ms		
Line regulation Voltage: Current:			< 10 $\mu$ V < 10 $\mu$ A		
Small signal bandwidth Voltage programming: <sup>10</sup> Current programming: <sup>11</sup> Voltage measurement: Current measurement:			DC to 1 kHz (-1dB); DC to 2 kHz (-3dB) DC to 70 Hz (-1dB); DC to 120 Hz (-3dB) DC to 14 kHz (-1dB); DC to 25 kHz (-3dB) DC to 14 kHz (-1dB); DC to 25 kHz (-3dB)		

2 kW Characteristics	N7970A	N7971A	N7972A	N7973A	N7974A
Minimum compliance limits Voltage priority: Current priority:	200 mA 9 mV	100 mA 20 mV	50 mA 40 mV	33 mA 60 mV	26 mA 80 mV
Voltage programming Range: Resolution:	0.009 to 9.18 V 0.21 mV	0.02 to 20.4 V 0.42 mV	0.04 to 40.8 V 0.84 mV	0.06 to 61.2 V 1.25 mV	0.08 to 81.6 V 1.68 mV
Current programming Range-no dissipator: Range-with dissipator: Resolution:	-20.4 to 204 A -204 to 204 A 3.8 mA	-10.2 to 102 A -102 to 102 A 1.9 mA	-5.1 to 51 A -51 to 51 A 0.95 mA	-3.4 to 33.97 A -33.97 to 33.97 A 0.64 mA	-2.55 to 25.5 A -25.5 to 25.5 A 0.48 mA
Current measurement range High range Low range	-450 to 450 A -22 to 22 A	-225 to 225 A -11 to 11 A	-112.5 to 112.5 A -5.5 to 5.5 A	-74.9 to 74.9 A -3.67 to 3.67 A	-56.2 to 56.2 A -2.75 to 2.75 A
Resistance programming Range: Resolution: Accuracy: <sup>1</sup>	0 to 0.05 $\Omega$ 0.4 $\mu\Omega$ 0.06% +1.6 m $\Omega$ *A	0 to 0.2 $\Omega$ 1.7 $\mu\Omega$ 0.06% +3.2 m $\Omega$ *A	0 to 0.8 $\Omega$ 7 $\mu\Omega$ 0.06% +6.4 m $\Omega$ *A	0 to 1.7 $\Omega$ 15 $\mu\Omega$ 0.06% +8.8 m $\Omega$ *A	0 to 3.2 $\Omega$ 27 $\mu\Omega$ 0.06% +12.8 m $\Omega$ *A
Voltage programming & measurement TempCo: <sup>2</sup>	0.0022% +30 $\mu$ V	0.0022%+60 $\mu$ V	0.0022%+120 $\mu$ V	0.0022%+180 $\mu$ V	0.0022%+220 $\mu$ V

2 kW Characteristics	N7970A	N7971A	N7972A	N7973A	N7974A
Current programming & measurement TempCo <sup>2</sup>					
High range:	0.0029%+500µA	0.0031%+250µA	0.0035%+120µA	0.0032%+80µA	0.0032%+60µA
Low range:	0.0040%+160µA	0.0041%+80µA	0.0045%+40µA	0.0042%+24µA	0.0041%+18µA
Resistance programming					
TempCo:	0.0043%	0.0045%	0.0049%	0.0046%	0.0045%
Over-Voltage Protection					
Maximum setting:	10.8 V	24 V	48 V	72 V	96 V
Response time: <sup>3</sup>	<30 µs	<30 µs	<30 µs	<30 µs	<30 µs
Accuracy:	0.03% +1 mV	0.03% +2 mV	0.03% +4 mV	0.03% +6 mV	0.03% +8 mV
Voltage measurement noise (peak): <sup>4</sup>	2 mV	3.5 mV	7 mV	10 mV	14 mV
Current measurement noise (peak) <sup>4</sup>	75 mA	45 mA	18 mA	12 mA	7 mA
High range:	50 mA	30 mA	12 mA	6 mA	3 mA
Low range:					
Output current noise <sup>5</sup>					
CC rms:	20 mA	20 mA	15 mA	15 mA	15 mA
Common mode current <sup>5</sup>					
CC rms:	2 mA	1 mA	1 mA	1 mA	2 mA
CC peak-to-peak:	15 mA	10 mA	10 mA	10 mA	10 mA
Voltage up-programming time <sup>6</sup>					
10% to 90%:			0.5 ms		
Settling time: <sup>8</sup>			1 ms		
Voltage down-programming time <sup>7</sup>					
90% to 10%:			0.35 ms		
Settling time: <sup>8</sup>			0.8 ms		
Current up- and down-programming time <sup>9</sup>					
10% to 90%:			2.5 ms		
90% to 10%:			2.5 ms		
Output-on delay time					
Voltage priority:			12 ms		
with Relay Option on:			38 ms		
Current priority:			14 ms		
with Relay Option on:			46 ms		
Line regulation					
Voltage:			< 10 µV		
Current:			< 10 µA		
Small signal bandwidth					
Voltage programming: <sup>10</sup>			DC to 1 kHz (-1dB); DC to 2 kHz (-3dB)		
Current programming: <sup>11</sup>			DC to 70 Hz (-1dB); DC to 120 Hz (-3dB)		
Voltage measurement:			DC to 14 kHz (-1dB); DC to 25 kHz (-3dB)		
Current measurement:			DC to 14 kHz (-1dB); DC to 25 kHz (-3dB)		

## 1 Quick Reference

- 1 Resistance programming accuracy varies with output current. For example, for an N7970A unit at 0.1Ω with a 50A transient, accuracy is:  $(0.1\Omega * 0.06\%) + (1.6\text{m}\Omega * \text{A}/50\text{A}) = 92 \mu\Omega$ .
- 2 Per degree C
- 3 From occurrence of over-voltage to start of shutdown
- 4 With single point averaging
- 5 From 20 Hz to 300 kHz for rms noise; from 20 Hz to 20 MHz for peak-to-peak noise
- 6 With full resistive load and a voltage transition from 0.1% to 100% of rated output
- 7 With no load and a voltage transition from 100% to 0.1% of rated output
- 8 From start of voltage change to within 0.1% of final full scale value
- 9 With full resistive load and a current transition from 0.1% to 100% or 100% to 0.1% of rated output
- 10 With High Bandwidth setting, no load condition (see [Voltage Programming Response](#))
- 11 With resistive load condition

## Supplemental Characteristics - Keysight N6900/N7900 High Voltage Series

2 kW Characteristics	N6976A	N6977A	N7976A	N7977A
Minimum compliance limits				
Voltage priority:	16 mA	13 mA	16 mA	13 mA
Current priority:	120 mV	160 mV	120 mV	160 mV
Voltage programming				
Range:	0.12 to 122.4 V	0.16 to 163.2 V	0.12 to 122.4 V	0.16 to 163.2 V
Resolution:	16.9 mV	22.5 mV	2.5 mV	3.6 mV
<b>N6900 Opt 301</b> Resolution:	2.5 mV	3.6 mV		
Current programming				
Range-no dissipator:	-1.7 to 17.034A	-1.275 to 12.75 A	-1.7 to 17.034A	-1.275 to 12.75 A
Range-with dissipator:	-17.034 to 17.034A	-12.75 to 12.75 A	-17.034 to 17.034A	-12.75 to 12.75 A
Resolution:	5 mA	3.8 mA	0.32 mA	0.24 mA
<b>N6900 Opt 301</b> Resolution:	0.32 mA	0.24 mA		
Current measurement range				
High range:	-37.6 to 37.6 A	-28.1 to 28.1 A	-37.6 to 37.6 A	-28.1 to 28.1 A
Low range:	N/A	N/A	-1.84 to 1.84 A	-1.37 to 1.37 A
<b>N6900 Opt 301</b> Low range:	-1.84 to 1.84 A	-1.37 to 1.37 A		
Resistance programming				
Range:	0 to 6.8 Ω	0 to 12.8 Ω	0 to 6.8 Ω	0 to 12.8 Ω
Resolution:	60 μΩ	108 μΩ	60 μΩ	108 μΩ
Accuracy: <sup>1</sup>	0.1% +17.7 mΩ*A	0.1% +25.6 mΩ*A	0.06% +17.7 mΩ*A	0.06% +25.6 mΩ*A
<b>N6900 Opt 301</b> Accuracy:	0.06% +17.7 mΩ*A	0.06% +25.6 mΩ*A		
Voltage programming & measurement				
TempCo: <sup>2</sup>	0.0022%+430μV	0.0022%+570μV	0.0022%+430μV	0.0022%+530μV
Current programming & measurement				
TempCo <sup>2</sup>	0.0065%+12μA	0.0058%+30μA	0.0036%+40μA	0.0036%+30μA
<b>N6900 Opt 301</b> TempCo:	0.0036%+40μA	0.0036%+30μA		
Current measurement low range TempCo <sup>2</sup>				
TempCo:	N/A	N/A	0.0046%+12μA	0.0045%+9μA
<b>N6900 Opt 301</b> TempCo:	0.0046%+12μA	0.0045%+9μA		

2 kW Characteristics	N6976A	N6977A	N7976A	N7977A
Resistance programming				
TempCo:	0.0060%	0.0060%	0.0050%	0.0046%
<b>N6900 Opt 301</b> TempCo:	0.0050%	0.0046%		
Over-Voltage Protection				
Maximum setting:	144 V	192 V	144 V	192 V
Response time: <sup>3</sup>	<30 $\mu$ s	<30 $\mu$ s	<30 $\mu$ s	<30 $\mu$ s
Accuracy:	0.03% +17 mV	0.03% +24 mV	0.03% +11 mV	0.03% +14 mV
<b>N6900 Opt 301</b> Accuracy:	0.03% +11 mV	0.03% +14 mV		
Voltage measurement noise (peak): <sup>4</sup>	18 mV	23 mV	18 mV	23 mV
Current measurement noise (peak) <sup>4</sup>	6 mA	4 mA	6 mA	4 mA
Current measurement low range noise (peak)	N/A	N/A	4 mA	2 mA
Output current noise <sup>5</sup>				
CC rms:	15 mA	15 mA	15 mA	15 mA
Common mode current <sup>5</sup>				
CC rms:	2 mA	2 mA	2 mA	2 mA
CC peak-to-peak:	10 mA	10 mA	10 mA	10 mA
Voltage up-programming time <sup>6</sup>			Also applies to <b>N6900 Opt 303</b>	
10% to 90%:	3 ms		0.5 ms	
Settling time: <sup>8</sup>	10 ms		1 ms	
Voltage down-programming time <sup>7</sup>			Also applies to <b>N6900 Opt 303</b>	
90% to 10%:	3 ms		0.35 ms	
Settling time: <sup>8</sup>	10 ms		0.8 ms	
Current up- and down-programming time <sup>9</sup>				
10% to 90%:	2.5 ms		2.5 ms	
90% to 10%:	2.5 ms		2.5 ms	
Output-on delay time				
Voltage priority:	12 ms		12 ms	
with Relay Option on:	38 ms		38 ms	
Current priority:	14 ms		14 ms	
with Relay Option on:	46 ms		46 ms	
Line regulation				
Voltage:	< 10 $\mu$ V		< 10 $\mu$ V	
Current:	< 10 $\mu$ A		< 10 $\mu$ A	
Small signal bandwidth	N/A		Also applies to <b>N6900 Opt 303</b>	
Voltage programming: <sup>10</sup>			DC to 1 kHz (-1dB); DC to 2 kHz (-3dB)	
Current programming: <sup>11</sup>			DC to 70 Hz (-1dB); DC to 120 Hz (-3dB)	
Voltage measurement:			DC to 14 kHz (-1dB); DC to 25 kHz (-3dB)	
Current measurement:			DC to 14 kHz (-1dB); DC to 25 kHz (-3dB)	

## 1 Quick Reference

- 1 Resistance programming accuracy varies with output current. For example, for an N7970A unit at 0.1Ω with a 50A transient, accuracy is:  $(0.1\Omega * 0.06\%) + (1.6\text{m}\Omega * \text{A}/50\text{A}) = 92 \mu\Omega$ .
- 2 Per degree C
- 3 From occurrence of over-voltage to start of shutdown
- 4 With single point averaging
- 5 From 20 Hz to 300 kHz for rms noise; from 20 Hz to 20 MHz for peak-to-peak noise
- 6 With full resistive load and a voltage transition from 0.1% to 100% of rated output
- 7 With no load and a voltage transition from 100% to 0.1% of rated output
- 8 From start of voltage change to within 0.1% of final full scale value
- 9 With full resistive load and a current transition from 0.1% to 100% or 100% to 0.1% of rated output
- 10 With High Bandwidth setting, no load condition (see [Voltage Programming Response](#))
- 11 With resistive load condition

## Common Characteristics

Common Characteristic	All Models
Command Processing Time	≤ 1 ms from receipt of command to start of output change. Applies to simple settings commands over the GPIB interface (see <a href="#">Command Processing Times</a> )
Digital Port	
Max voltage rating:	+16.5 VDC/- 5 VDC between pins
Pins 1 & 2 as FLT:	Maximum low-level output voltage = 0.5 V @ 4 mA Maximum low-level sink current = 4 mA Typical high-level leakage current = 1 mA @ 16.5 VDC
Pins 1-7 as outputs:	Maximum low-level output voltage = 0.5 V @ 4 mA; 1 V @ 50 mA; 1.75 V @ 100 mA Maximum low-level sink current = 100 mA Typical high-level leakage current = 0.8 mA @ 16.5 VDC
Pins 1-7 as inputs:	Maximum low-level input voltage = 0.8 V Minimum high-level input voltage = 2 V Typical low-level current = 2 mA @ 0 V (internal 2.2k pull-up) Typical high-level leakage current = 0.12 mA @ 16.5 VDC
Pin 8:	Pin 8 is common (internally connected to chassis ground)
Computer Interfaces	
LXI Core 2011	10/100 Base-T Ethernet (Sockets, VXI-11 protocol, Web user interface)
USB	USB 2.0 (USB-TMC488 protocol)
GPIB	GPIB IEEE 488
Language	SCPI - 1993, IEEE 488.2 compliant
Regulatory Compliance	
EMC:	Complies with European EMC Directive for test and measurement products Complies with Australian standard and carries C-Tick mark This ISM device complies with Canadian ICES-001 Cet appareil ISM est conforme à la norme NMB-001 du Canada
Safety:	Complies with European Low Voltage Directive and carries the CE-marking. Conforms to US and Canadian safety regulations.  Declarations of Conformity for this product may be downloaded from the Web. Go to <a href="http://www.keysight.com/go/conformity">http://www.keysight.com/go/conformity</a> and click on "Declarations of Conformity."

Common Characteristic	All Models
Environmental Operating environment: Temperature range: Relative humidity: Altitude: Storage temperature:	Indoor use, installation category II (for AC input), pollution degree 2 0°C to 55°C (Maximum continuous power available is derated at 1% of rating per degree C from 40°C to 55°C) 95% or less (non-condensing) Up to 2000 meters -30°C to 70°C
Acoustic Noise Declaration	Complies with the requirements of the German Sound Emission Directive from 18 January 1991. Sound Pressure Lp <70 dB(A), At Operator Position, Normal Operation, According to EN 27779 (Type Test).
Output Terminal Isolation Maximum rating:	No output terminal may be more than ±240 VDC from any other terminal or chassis ground.
AC Input Nominal Ratings: Input Range: Power Consumption: Power Factor: Fuse:	100–120, 200–240 VAC 50/60 Hz 100–120, 208 VAC 400 Hz ±10% of nominal ratings 2000 VA for 1 kW units; 2850 VA for 2 kW units 0.99 @ nominal input and rated power Internal fuse - not user accessible  <b>NOTE:</b> AC mains circuits rated at 100-120 VAC cannot supply enough current to power either the 1 kW or the 2 kW models when operated at their full rated output power. When connected to a 100-120 VAC mains, the instrument turns off the output and sets either the CP+ or PF status bit when the output power exceeds 700W.
Typical Weight	1 kW models: 23 lbs. (10.5 kg.) 2 kW models: 34 lbs. (15.5 kg.) N7909A: 18 lbs. (8.2 kg.)

## Output Impedance Graphs

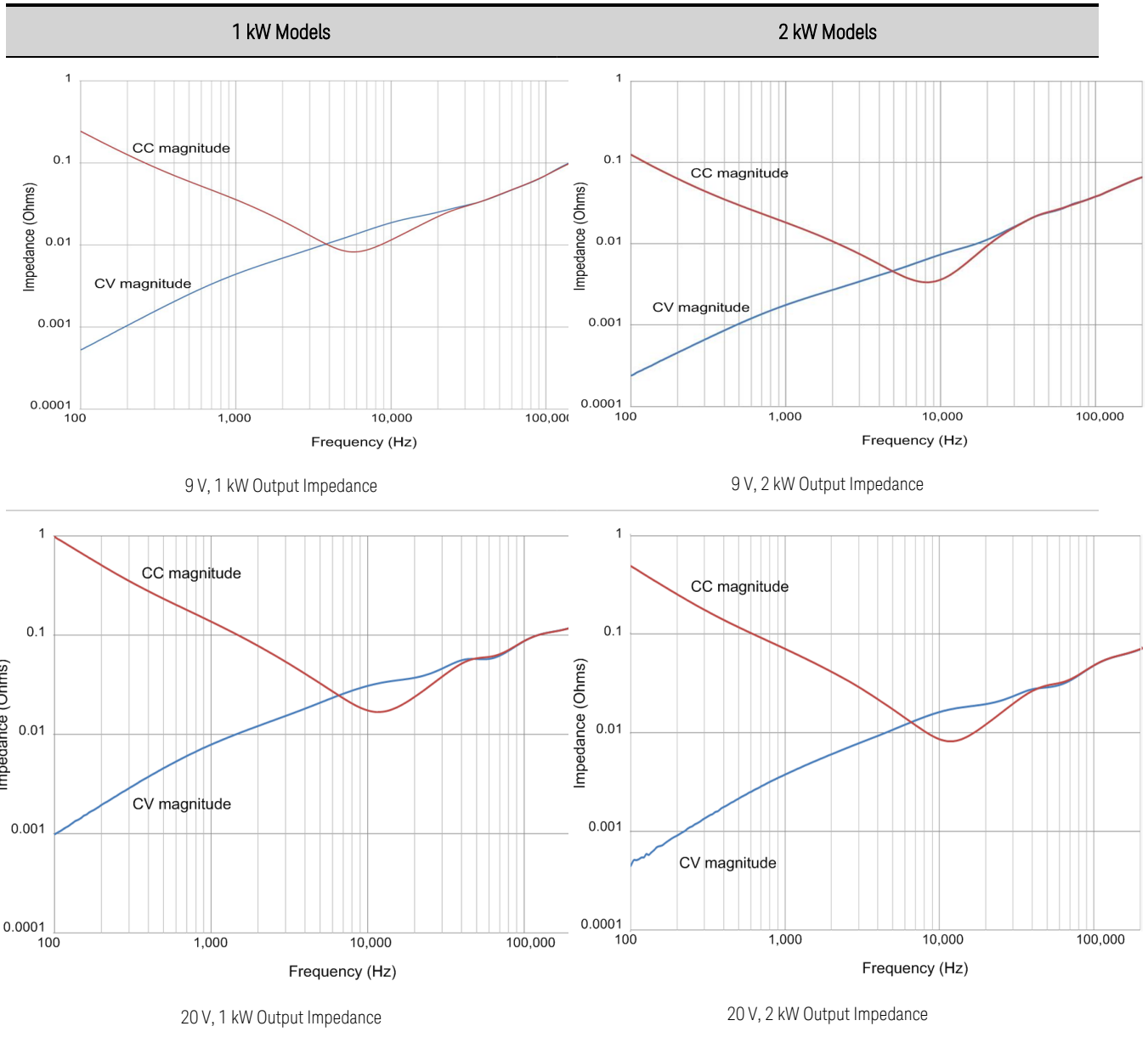

1 kW Models	2 kW Models
-------------	-------------

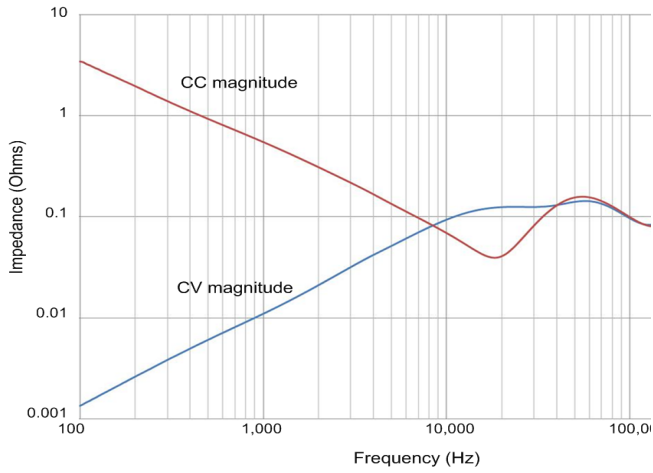

40 V, 1 kW Output Impedance

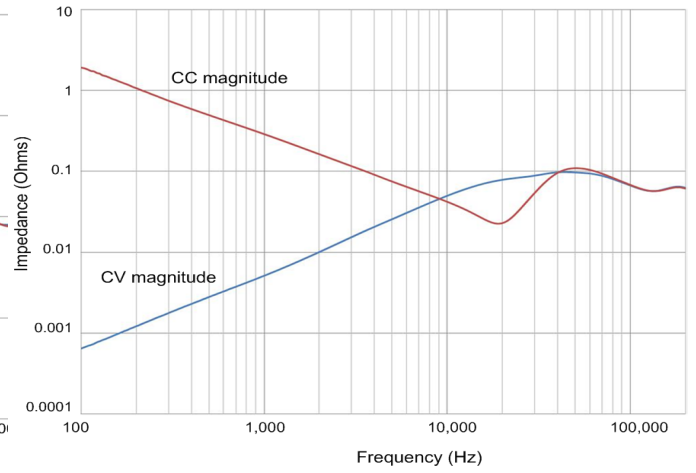

40 V, 2 kW Output Impedance

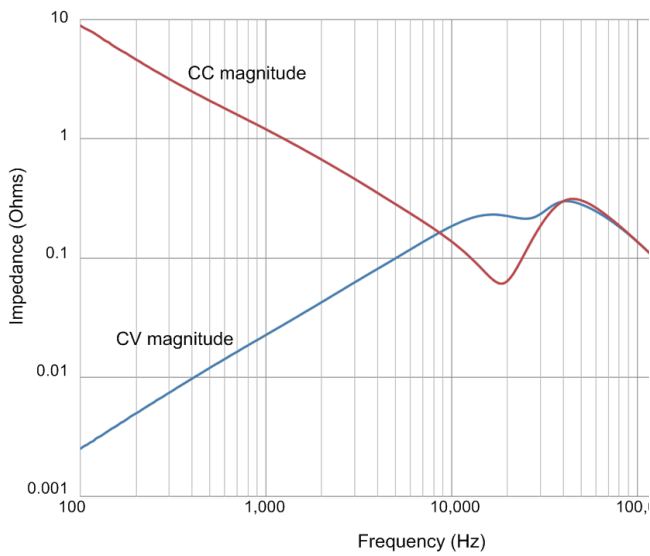

60 V, 1 kW Output Impedance

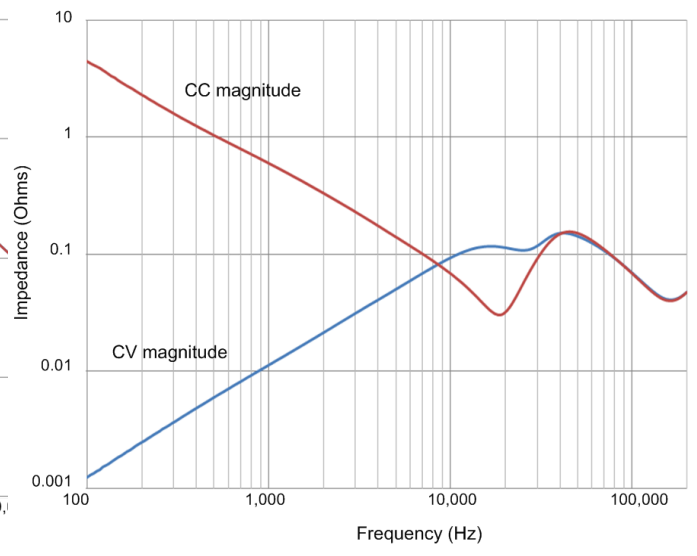

60 V, 2 kW Output Impedance

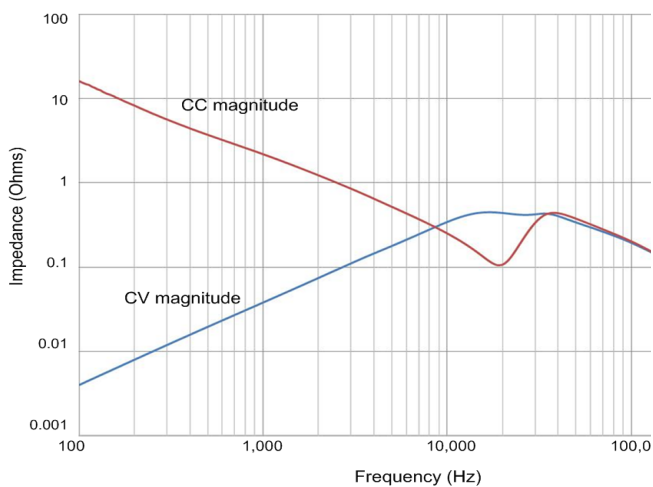

80 V, 1 kW Output Impedance

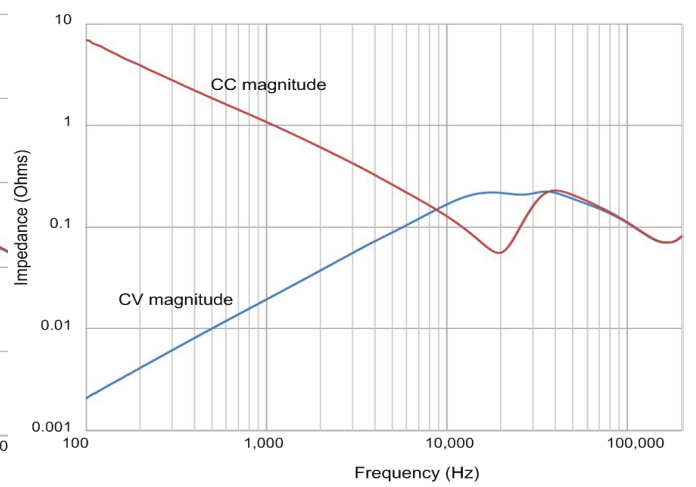

80 V, 2 kW Output Impedance

# 1 Quick Reference

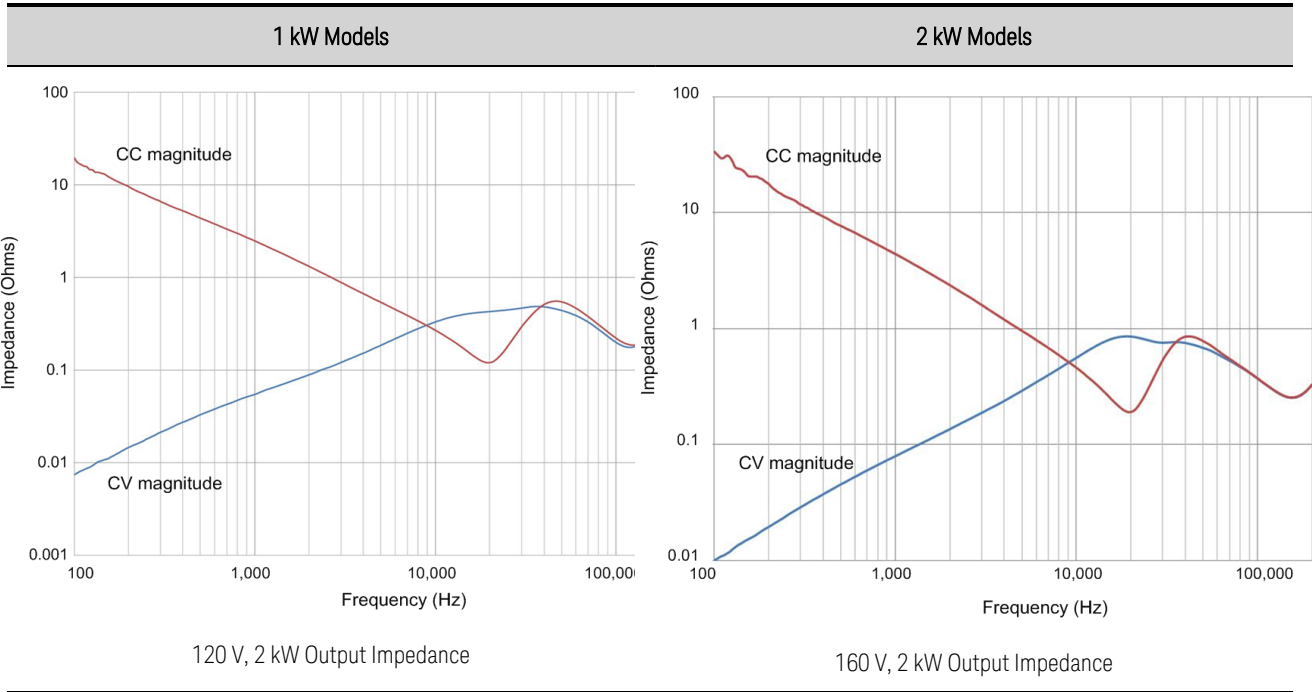

## Inductive Load Boundary

The following figures show the boundary limitation for inductive loads and for fast CV/CC mode crossover operation. Operation above the inductive load boundary may result in output instability. The boundary limit represents operating conditions including a 20% current overshoot. Note that increased load resistance allows increased output inductance.

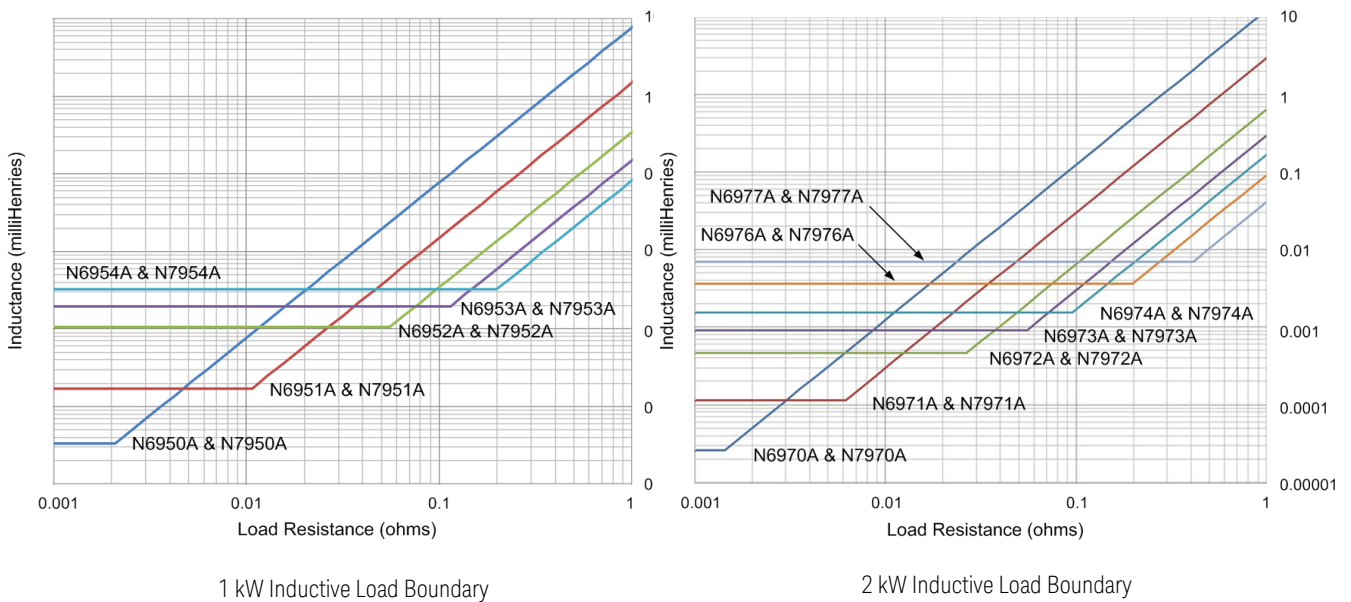

## Output Quadrants

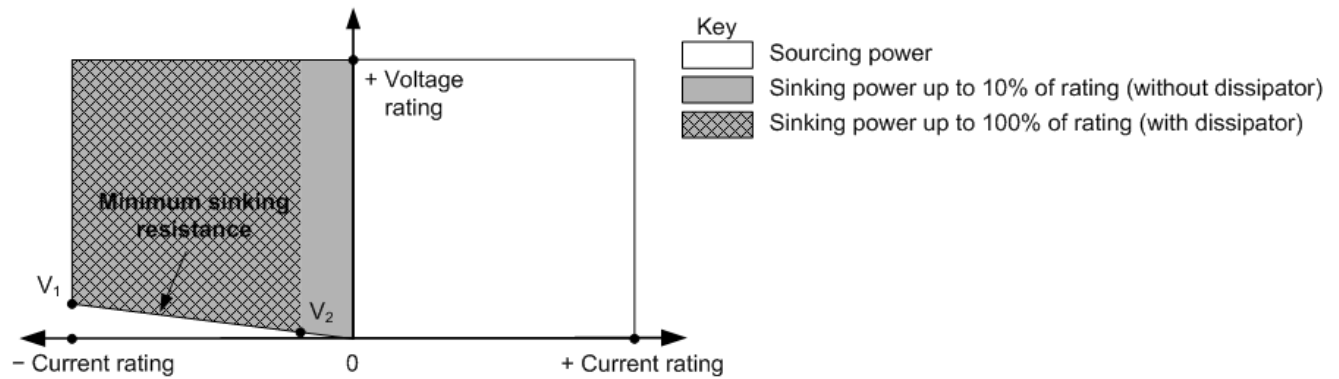

1 kW Models	N6950A N7950A	N6951A N7951A	N6952A N7952A	N6953A N7953A	N6954A N7954A
+ Voltage rating	9 V	20 V	40 V	60 V	80 V
+ Current rating	100 A	50 A	25 A	16.7 A	12.5 A
- Current rating (with dissipator)	-100 A	-50 A	-25 A	-16.7 A	-12.5 A
V <sub>1</sub>	0.68 V	0.525 V	1.9 V	1.47 V	2 V
V <sub>2</sub>	0.068 V	0.0525 V	0.19 V	0.147 V	0.2 V
Minimum sinking res- istance	6.8mΩ	10.5mΩ	76 mΩ	89 mΩ	160mΩ

2 kW Models	N6970A N7970A	N6971A N7971A	N6972A N7972A	N6973A N7973A	N6974A N7974A	N6976A N7976A	N6977A N7977A
+ Voltage rating	9 V	20 V	40 V	60 V	80 V	120 V	160 V
+ Current rating	200 A	100 A	50 A	33.3 A	25 A	16.7 A	12.5 A
- Current rating (with dissipator)	-200 A	-100 A	-50 A	-33.3 A	-25 A	-16.7 A	-12.5 A
V <sub>1</sub>	0.68 V	0.525 V	1.9 V	1.47 V	2 V	3 V	4 V
V <sub>2</sub>	0.068 V	0.0525 V	0.19 V	0.147 V	0.2 V	0.3 V	0.4 V
Minimum sinking res- istance	3.4mΩ	5.2mΩ	38 mΩ	45 mΩ	80mΩ	180 mΩ	320 mΩ

## Voltage Programming Response

The following graphs show the output voltage programming response characteristic. These graphs apply for small signals only, under no load condition.

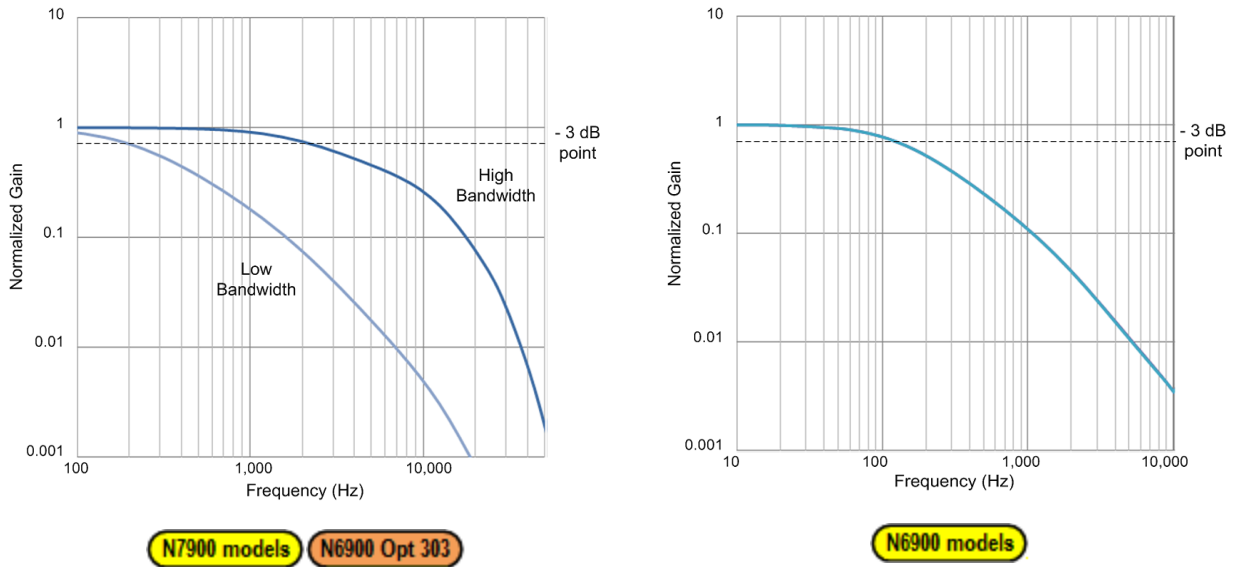

## Output Dynamic Response N7900 models N6900 Opt 303

The following graph shows the square wave amplitude thresholds versus frequency for each model. Above the indicated amplitude threshold, sustained generation of a square wave may lead to engagement of the excessive dynamic protection (EDP) function, which disables the output. EDP protection may be engaged by programmed voltage changes, lists, Arbs, or load-induced voltage swings.

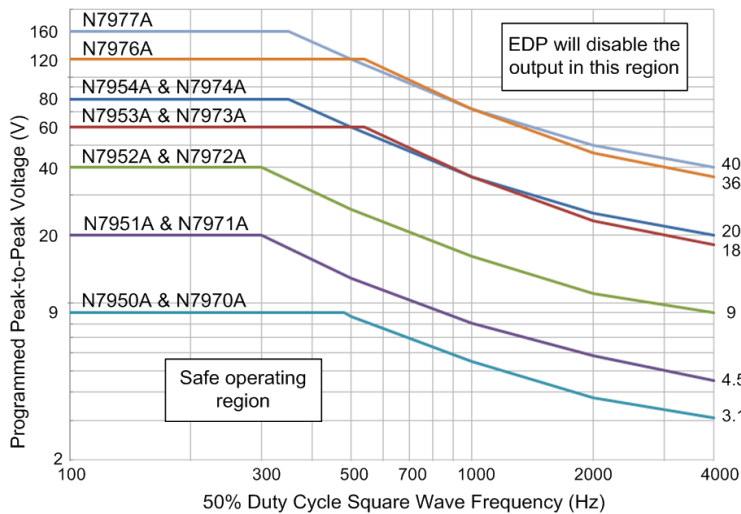

Maximum Peak-to-Peak Programmable Voltage vs. Square Wave Frequency

## Measurement Accuracy and Resolution - with shorter measurement intervals

The following table shows changes to the short-term measurement accuracy and resolution with various number of power line cycle (NPLC) measurement settings. Changes are due to the A-to-D converter's noise performance. The table's baseline is 1 NPLC with no added noise. To determine the measurement accuracy at shorter averaging intervals, simply calculate the percent of range to add, then add it to the fixed accuracy value in the specification table.

For example, to determine the percent of range to add to the accuracy specification of the voltage measurement of an N6950A when making measurements at 0.003 NPLC, simply multiply the full voltage rating by the "% of range added to spec value" as follows:  $9\text{ V} \times 0.006\% = 0.54\text{ mV}$ . Add this number to the offset part of the measurement accuracy specification:  $1.5\text{ mV} + 0.54\text{ mV}$ . The new voltage measurement accuracy is  $0.03\% + 2.04\text{ mV}$  at 0.003 NPLC.

NPLC @60Hz	Number of averaged points	Voltage Measurement		Current Measurement		Low Current Measurement	
		% of range added to spec.	Effective Resolution (in bits)	% of range added to spec.	Effective Resolution (in bits)	% of range added to spec.	Effective Resolution (in bits)
1	3255	0	>20	0	>19	0	>16
0.6	1953	0.00001%	19.9	0.00026%	18.6	0.002%	15.6
0.1	325	0.00076%	17.0	0.0019%	15.7	0.015%	12.7
0.06	195	0.0011%	16.5	0.0027%	15.2	0.022%	12.2
0.031	100	0.0016%	15.9	0.0041%	14.6	0.033%	11.6
0.010	33	0.0031%	15.0	0.0078%	13.6	0.063%	10.6
0.006	20	0.0041%	14.6	0.010%	13.3	0.082%	10.3
0.003	10	0.006%	14.0	0.015%	12.7	0.120%	9.7
0.0003	1	0.02%	12.3	0.049%	11.0	0.390%	8.0

The measurement A-to-D converter has an 18-bit resolution. However, the combination of measurement noise and data-point averaging can yield a different effective resolution as shown in the table. With single point measurements without averaging, the noise in the measurement signal is much larger than the A-to-D converter's resolution, thereby limiting successive measurement repeatability. Averaging more data points can increase the measurement precision beyond the A-to-D converter's native resolution. For example, the measurement repeatability of an N7950A's high current range with a 0.6 NPLC setting yields an effective resolution of 18.6 bits. Convert the bits to current by applying the bits to the full current rating as follows:  $100\text{ A} \times 2^{-18.6} = 252\text{ }\mu\text{A}$ . The measurement resolution is 252  $\mu\text{A}$ .

**Dimension Diagrams - all dimensions in millimeters**

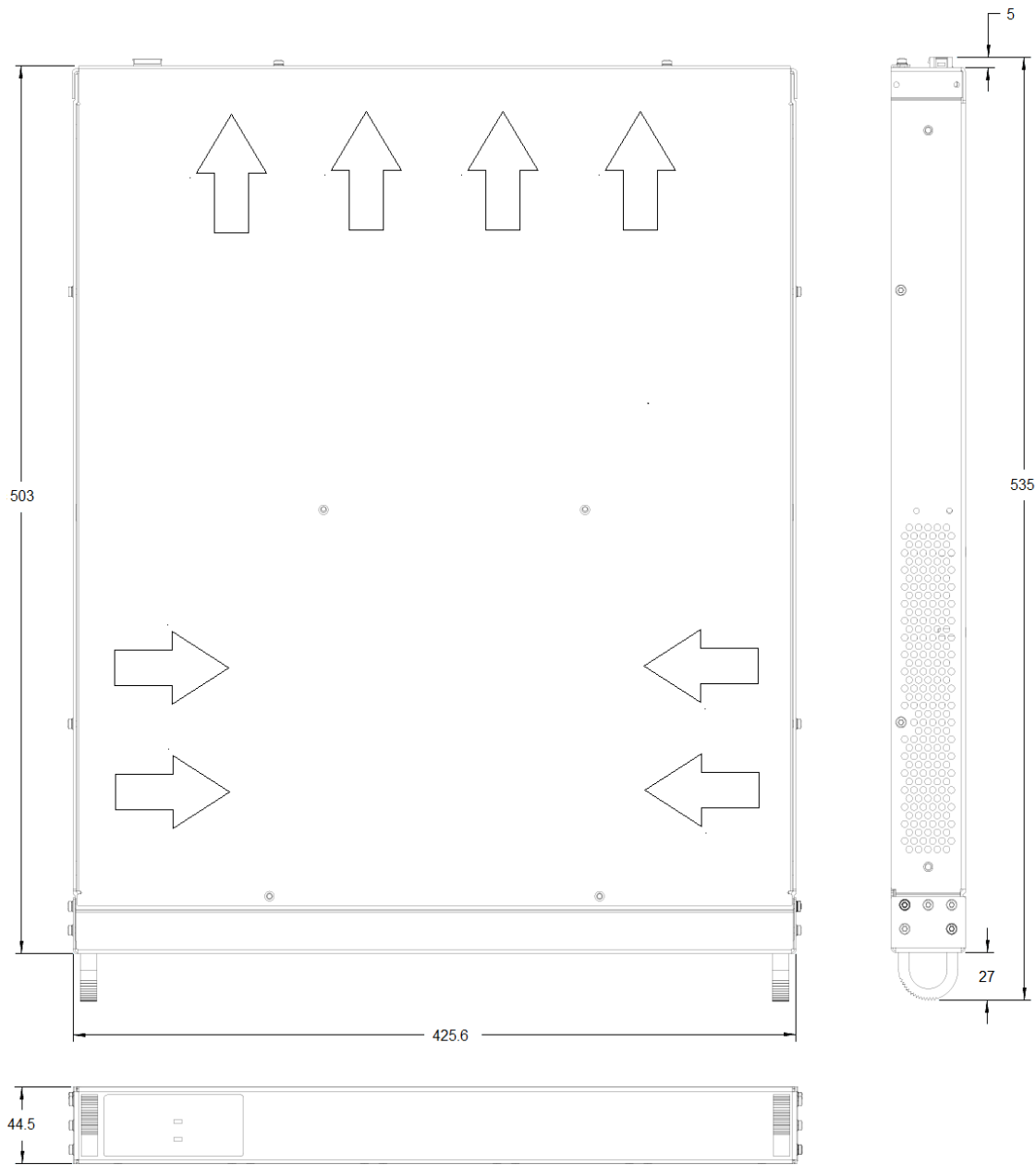

**Power Dissipator Unit**

1 Quick Reference

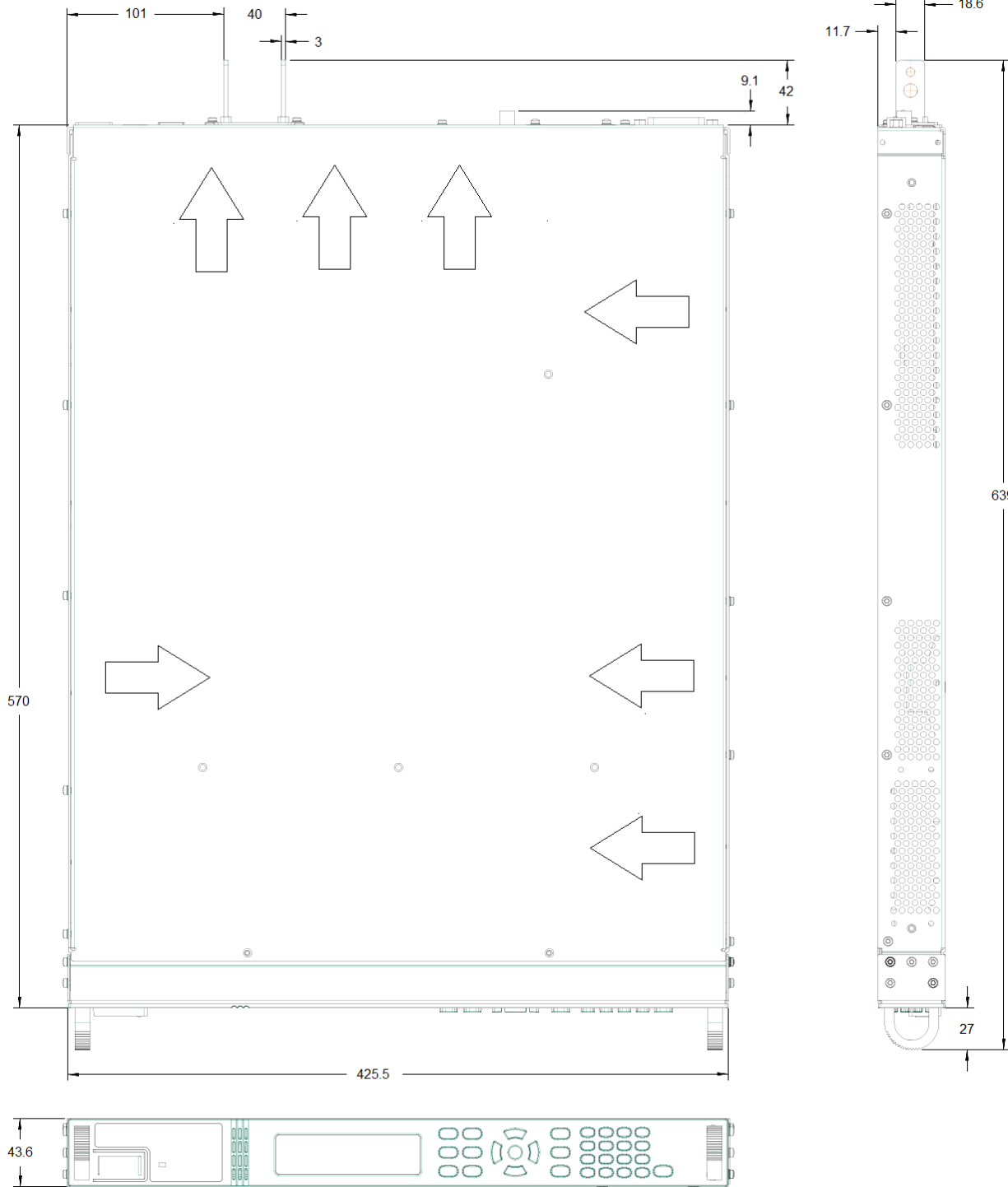

1 kW Models

# 1 Quick Reference

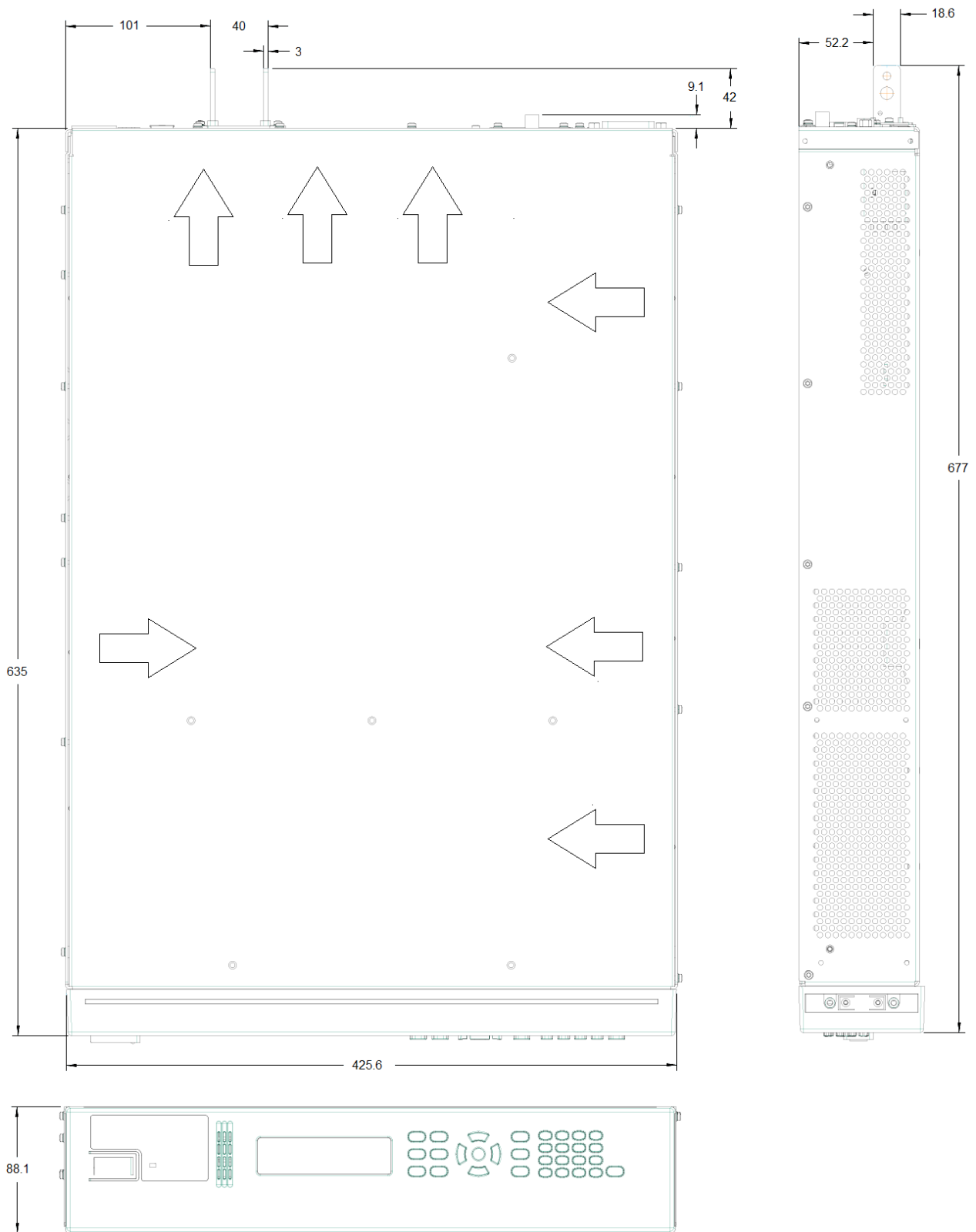

## 2 kW Models

# 2

## Installing the Instrument

**Before Installation or Use**

**Single Unit Connections**

**Parallel Connections**

**Series Connections**

**Power Dissipator Connections**

**Interface Connections**

**Rack Mounting**

**Black Box Recorder**

## Before Installation or Use

### Inspect the Unit

When you receive your APS unit, inspect it for any obvious damage that may have occurred during shipment. If there is damage, notify the shipping carrier and nearest Keysight Sales and Support Office immediately. Refer to [www.keysight.com/find/assist](http://www.keysight.com/find/assist).

Until you have checked out the unit, save the shipping carton and packing materials in case the unit has to be returned.

### Check for Items Supplied

Before getting started, check the following list and verify that you have received these items. If anything is missing, please contact your nearest Keysight Sales and Support Office.

<b>N6900/N7900 Items</b>	<b>Description</b>	<b>Part Number</b>
Power Cord	A power cord suitable for your location	Call the Keysight Sales and Support Office
Product Reference CD	Includes software and documentation	Keysight N7900-13601
Connector Kit	Includes the following three items:	Keysight 5067-5541
- Digital connector plug	8-pin connector for the digital port	Keysight 1253-6408; Phoenix Contact 1840421
- Sharing connector plug	3-pin connector for the sharing port	Keysight 0360-3038; Phoenix Contact 1840379
- Sense cable	2-pin + and - sense wire cable	Keysight 5190-4501 Plug only: Keysight 1253-8485; Phoenix Contact 1952267
Safety cover	Safety cover for output bus bars	Keysight 5003-1126
Hardware kit	1-set hardware for high current bus bars 1-set hardware for low current bus bars	Keysight 5067-6031
Calibration certificate	Referenced to instrument serial number	None
<b>N7909A Items</b>	<b>Description</b>	<b>Part Number</b>
Installation sheet	Contains installation information	N7909-90001
Dissipator power cable plugs	2 connector plugs for <b>fabricated cable</b>	Keysight 0360-3050; Phoenix Contact 1718481
Dissipator interface cable	1 m cable (CAT6A) for interface connections	Keysight 8121-2314

## Review Safety Information

This power supply is a Safety Class 1 instrument, which means it has a protective earth terminal. That terminal must be connected to earth ground through a power source equipped with an earth ground. Refer to the [Safety Summary](#) page for general safety information. Before installation or operation, check the power supply and review this guide for safety warnings and instructions. Safety warnings for specific procedures are located at appropriate places throughout this guide.

**WARNING**

Some models generate voltages in excess of 60 VDC. Ensure that all instrument connections, load wiring, and load connections are either insulated or covered so that no accidental contact with lethal output voltages can occur.

## Observe Environmental Conditions

**WARNING**

Do not operate the instrument in the presence of flammable gases or fumes.

The environmental conditions of the power supply are documented under [Specifications](#). Basically, the unit should only be operated indoors in a controlled environment. Do not operate the unit in areas where the ambient temperature exceeds +55 degrees Celsius. This applies for rack-mounting as well as for bench use.

## Provide Adequate Air Flow

**CAUTION**

Do not block the air intake at the sides of the instrument or the exhaust at the rear of the instrument.

The dimensions of your power supply as well as an outline diagram are given under [Specifications](#). Fans cool the power supply by drawing air through the sides and exhausting it out the back. The unit must be installed in a location that allows sufficient space of at least 2 inches (51 mm) at the sides and back of the unit for adequate air circulation.

## Single Unit Connections

### Line Cord Connection

### Output Connections

### Single Load Connections

### Multiple Load Connections

### Remote Sense Connections

### Additional Load Considerations

## Line Cord Connection

#### WARNING

**FIRE HAZARD** Use only the power cord that was supplied with your instrument. Using other types of power cords may cause overheating of the power cord, resulting in fire.

**SHOCK HAZARD** The power cord provides a chassis ground through a third conductor. Be certain that your power outlet is of the three-conductor type with the correct pin connected to earth ground.

Connect the power cord that was supplied with your unit to the AC mains connector on the rear of the unit. If the wrong power cord was shipped with your unit, contact your nearest Keysight Sales and Support Office.

The AC input on the back of your unit is a universal AC input. It accepts nominal line voltages in the range of 100 VAC to 240 VAC. The frequency can be 50 Hz, 60 Hz, or 400 Hz.

#### NOTE

The detachable power cord may be used as an emergency disconnecting device. Removing the power cord will disconnect AC input power to the unit. Ensure that the power cord is accessible.

## Operation With AC Mains Circuits Rated Below 180 VAC

AC mains circuits rated at 100-120 VAC cannot supply enough current to power either the 1 kW or the 2 kW models when operated at their full rated output power. When connected to a 100-120 VAC mains, the instrument turns off the output and sets either the CP+ or PF status bit when the output power exceeds 700W.

## 400 Hz Operation

#### WARNING

### Redundant Ground Requirement

At 400 Hz AC input operation, the leakage current of the unit exceeds 3.5 mA. This requires the installation of a permanent, redundant ground from the instrument chassis to earth ground. This ensures that ground will always be connected and that any leakage current will be diverted to ground. Refer to **Redundant Ground** for installation instructions.

## Sense Connections

A sense cable is shipped along with your instrument. Install the sense cable between the sense connector to the output terminals. Insert the plug into the sense connector and attach the spade connectors to the screws provided on the output terminals.

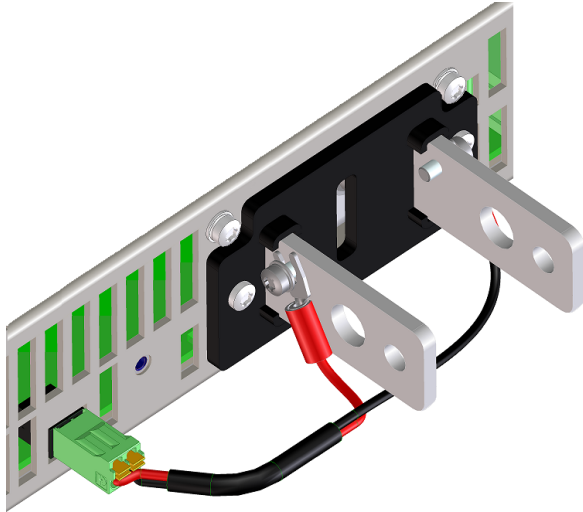

### CAUTION

Observe polarity when installing the sense cable.

If the sense cable is not installed prior to instrument turn-on or becomes disconnected, the instrument responds with a sense fault (SF) status indication on the front panel. The unit will continue to operate, but the voltage at the output terminals will be approximately 1% higher than the programmed value. Once the sense cable is connected, instrument status and operation returns to normal.

## Output Connections

### WARNING

**SHOCK HAZARD** Turn off AC power before making rear panel connections. Some models generate voltages in excess of 60 VDC. Ensure that all instrument connections, load wiring, and load connections are either insulated or covered so that no accidental contact with lethal output voltages can occur.

The following factors should be considered when wiring the load to the power supply:

- Load wire current carrying capacity
- Load wire insulation rating (must be equivalent to the maximum output voltage)
- Load wire voltage drop
- Load wire noise and impedance effect

## Wire Size

**WARNING**

FIRE HAZARD To satisfy safety requirements, load wires must be large enough not to overheat when carrying the maximum short circuit current of the power supply. If there is more than one load, then any pair of load wires must be capable of safely carrying the full-rated current of the supply. Paralleled load wires may be required for larger-ampacity power supplies.

The following table lists the characteristics of AWG (American Wire Gauge) copper wire.

AWG	Equivalent mm <sup>2</sup>	Nearest Metric size	Ampacity (Note1)	Resistance (Note2)
18	0.823	1.0 mm <sup>2</sup>	14	6.385
16	1.31	1.5 mm <sup>2</sup>	18	4.016
14	2.08	2.5 mm <sup>2</sup>	25	2.526
12	3.31	4 mm <sup>2</sup>	30	1.589
10	5.26	6 mm <sup>2</sup>	40	0.9994
8	8.37	10 mm <sup>2</sup>	60	0.6285
6	13.30	16 mm <sup>2</sup>	80	0.3953
4	21.15	25 mm <sup>2</sup>	105	0.2486
2	33.62	35 mm <sup>2</sup>	140	0.1564
1/0	53.48	70 mm <sup>2</sup>	195	0.0983
2/0	67.43	70 mm <sup>2</sup>	225	0.0779
3/0	84.95	95 mm <sup>2</sup>	260	0.0618

Note 1. Ampacity is based on 26-30 °C ambient temperature with the conductor rated at 60 °C. Ampacity decreases at higher temperatures.

Note 2. Resistance is in ohms/1000 feet, at 20 °C wire temperature.

Along with conductor temperature, you must also consider voltage drop when selecting wire sizes. The power supply will tolerate a voltage drop of 1 V per lead while maintaining the specified output programming and measurement accuracy (see **N6900** and **N7900** specifications). Voltage drops of up to 25% of the rated output voltage per lead will be tolerated with only slightly reduced output programming and measurement accuracy. Of course, any voltage drop in the load leads reduces the maximum voltage available at the load. The load lead drop must be subtracted from the rated voltage of the power supply to determine the maximum voltage available at the load.

## Single Load Connections

**CAUTION**

Tightening torque cannot exceed 10.8 Nm (8 lb-ft).

1. As shown in the following figure, terminate all load wires with wire terminal lugs securely attached. DO NOT use unterminated wires for load connections at the power supply.
2. Route the wires through the safety cover before attaching them to the bus bars. Knockouts are provided on for larger diameter wires. The figure illustrates the recommended hardware for connecting wires to the bus bars. You must provide all cabling. Ensure that the wire-mounting hardware does not short the output terminals.
3. Attach the wire terminals to the inside of the bus bars to ensure enough space for installing the shield. Twist or bundle the load wires to reduce lead inductance and noise pickup. The goal is to always minimize the loop area or physical space between the + and - output leads from the power supply to the load.
4. Attach the safety cover to the rear panel. Note that heavy wiring cables must have some form of strain relief to prevent bending the safety cover or bus bars.

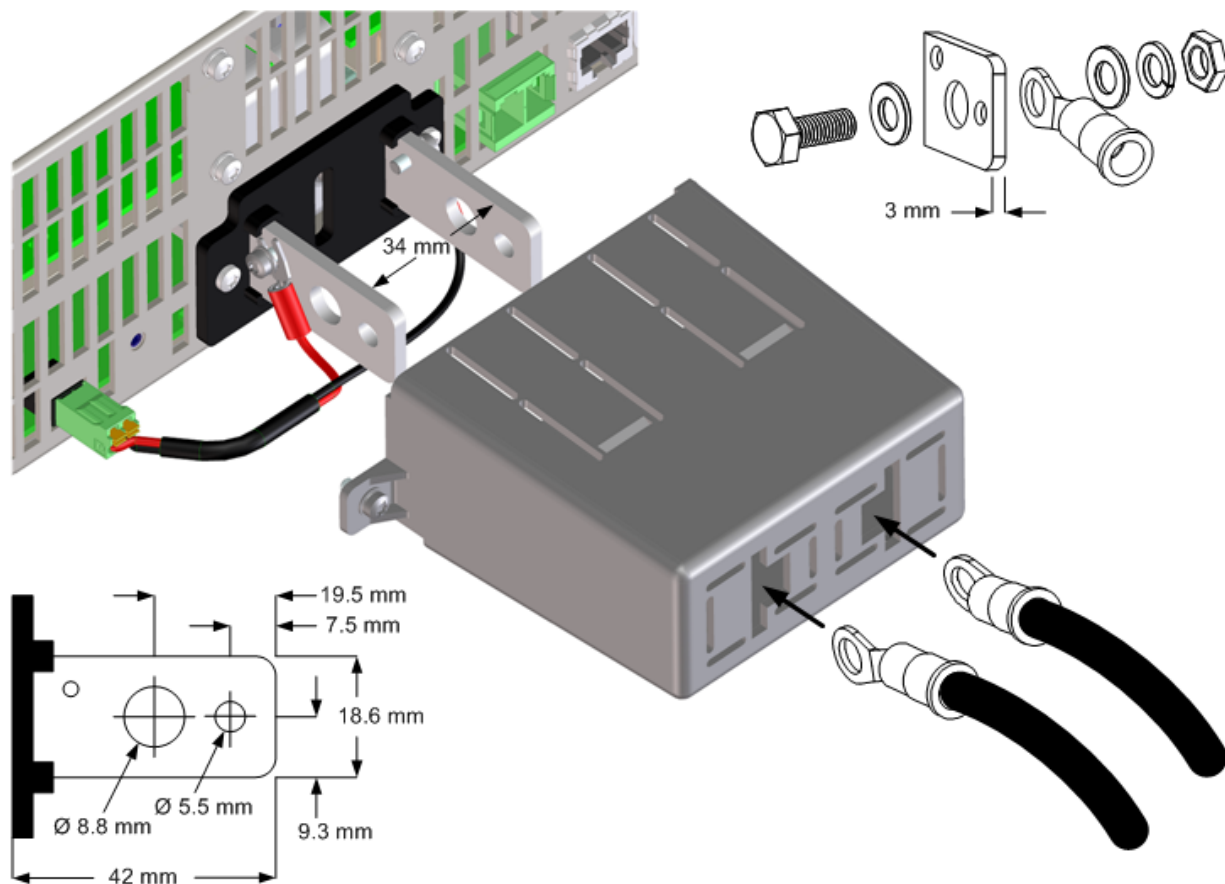

## Multiple Load Connections

If you are using local sensing and are connecting multiple loads to one output, connect each load to the output terminals using separate connecting wires as shown in the following figure. This minimizes mutual coupling effects and takes full advantage of the power supply's low output impedance. Keep each pair of wires as short as possible and twist or bundle them to reduce lead inductance and noise pickup. The goal is to always minimize the loop area or physical space between the + and - output leads from the power supply to the load.

If load considerations require the use of distribution terminals that are located away from the power supply, twist or bundle the wires from the output terminals to the remote distribution terminals. Connect each load to the distribution terminals separately. Remote voltage sensing is recommended under these circumstances. Sense either at the remote distribution terminals or, if one load is more sensitive than the others, directly at the critical load.

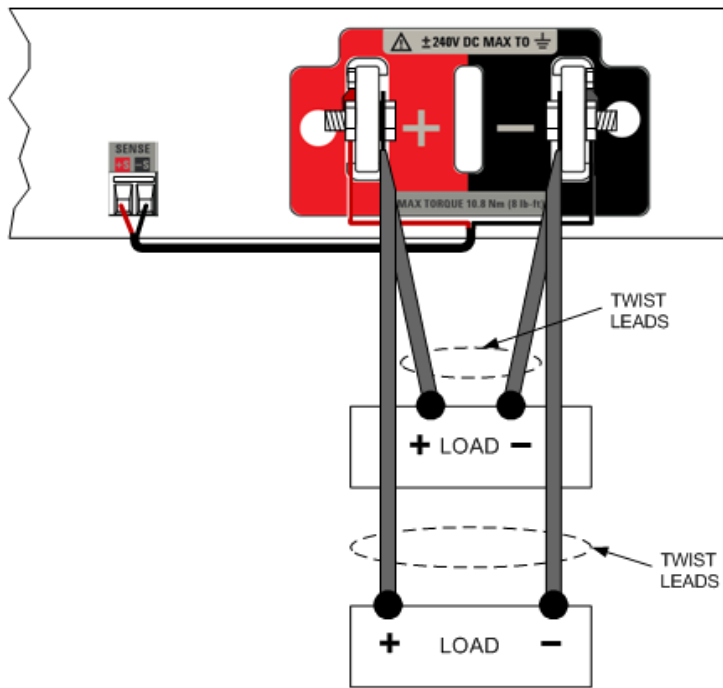

## Remote Sense Connections

Remote sensing improves the voltage regulation at the load by monitoring the voltage there instead of at the output terminals. This allows the power supply to automatically compensate for the voltage drop in the load leads. Remote sensing is especially useful for CV operation with load impedances that vary or have significant lead resistance. It has no effect during CC operation. Because sensing is independent of other power supply functions, remote sensing can be used regardless of how the power supply is programmed.

Connect the unit for remote sensing as follows:

- First remove the sense cable between sense and load terminals
- Push in the orange release tabs with a small flat-blade screwdriver to release and insert the sense wires.
- Keep the sense wire size between AWG 16 (1.5 mm<sup>2</sup>) maximum and AWG 24 (0.2 mm<sup>2</sup>) minimum.
- Strip the wire insulation back 10 mm.

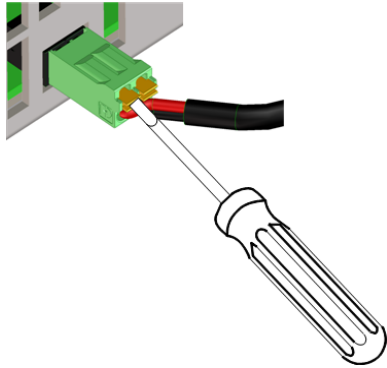

Make your connections as shown in the following figure. Connect the load to the output terminals using separate connecting wires. Keep the wire-pair as short as possible and twist or bundle it to reduce lead inductance and noise pickup. Keep load leads under 14.7 meters (50 feet) per lead because of inductance effects.

Connect the sense leads as close to the load as possible. Do NOT bundle the sense wire-pair together with the load leads; keep the load wires and sense wires separate. Sense wiring can be of a lighter gauge than the load wiring. The sense leads can carry up to 1 mA of current without degrading the current measurement. Note however, that any voltage drop in the sense leads can degrade the output voltage regulation. Try to keep the sense lead resistance less than about 0.5  $\Omega$  per lead (this requires 20 AWG or heavier for a 50 foot length).

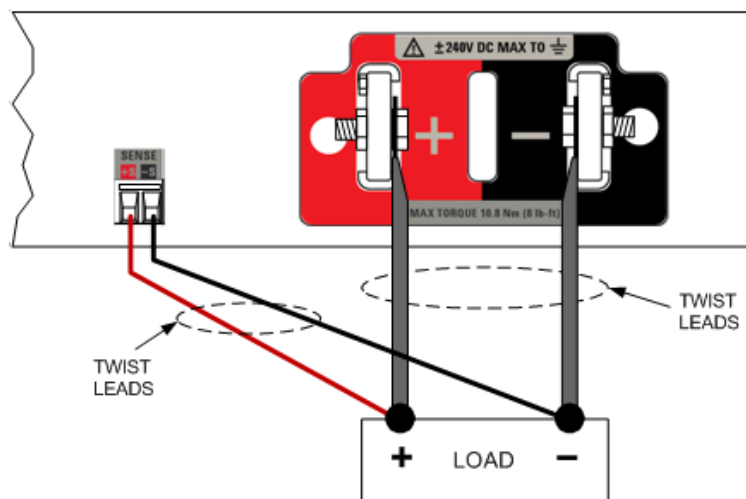

## Open/Shorted/Reverse Sense Lead Detection

The sense leads are part of the output's feedback path. Connect them in such a way so that they do not inadvertently become open circuited. When an open sense lead is detected prior to output turn-on or while the output is on, the instrument responds with a sense fault (SF) status indication on the front panel. The response time is about 50 microseconds. You can use the **Advanced Signal Routing** capability to turn this fault into an output protection feature. Otherwise, the power supply returns to local sensing mode, with the voltage at the output terminals approximately 1% higher than the programmed value. Once the sense wires are reconnected, instrument status and operation returns to normal.

You can disable this feature if it creates objectionable disruptions at the DUT or if the lead configuration or load dynamics cause the system to falsely trip.

Front Panel Menu Reference	SCPI Command
Select <b>Protect\SFD</b>	To enable/disable sense fault detection: <b>SENS:FAUL:STAT ON OFF</b>
Check <b>Enable sense fault detection</b> to enable; uncheck to disable. Then press <b>Select</b> .	

Shorted sense leads are detected by the over-voltage protection function. This function is not programmable and results in the output being disabled due to an over-voltage fault (OV).

Reversed sense leads are detected by the negative over-voltage protection function. This function is not programmable and results in the output being disabled due to a negative over-voltage fault (OV-).

### NOTE

It is very important to make sure the sense wires are connected properly. This is because the over-voltage protection cannot detect sense lead mis-wiring without enabling the output, thereby briefly subjecting the load to unintended voltages.

## Over-voltage Protection

Over-voltage protection (OVP) provides a configurable over-voltage protection based on sense lead voltage. Having the OVP circuit monitor the sense lead voltage rather than the output terminal voltage allows for more precise voltage monitoring directly at the load. Since incorrect sense wiring could defeat this feature, there is also a backup local OVP function. Refer to **Programming Output Protection** for further information.

The backup local OVP function tracks the programmed OVP setting and trips if the voltage at the + and - output terminals rises more than 1V + 10% of the unit's voltage rating above the programmed OVP setting.

## Output Noise

Any noise picked up on the sense leads will appear at the output terminals and may adversely affect CV load regulation. Twist the sense leads or use a ribbon cable to minimize the pickup of external noise. In extremely noisy environments it may be necessary to shield the sense leads. Ground the shield at the power supply end only; do not use the shield as one of the sensing conductors.

The noise specifications documented under **Specifications** apply at the output terminals when using local sensing. However, voltage transients may be produced at the load by noise induced in the leads or by load current transients acting on the inductance and resistance of the load lead. If it is desirable to keep voltage transient levels to a minimum, place an aluminum or tantalum capacitor, with an approximate value of 10 microfarad per foot (30.5 cm) of load lead, right across the load.

## Additional Load Considerations

### Response Time With External Capacitor

When programming with an external capacitor, voltage response time may be longer than that for purely resistive loads. Use the following formula to estimate the additional up-programming response time:

$$\text{Response Time} = \frac{(\text{added output capacitor}) \times (\text{change in } V_{\text{out}})}{(\text{current limit setting}) - (\text{load current})}$$

Note that programming into an external output capacitor may cause the power supply to briefly enter constant current operating mode, which adds additional response time. By setting the proper voltage slew rate when using an external capacitor, it may be possible to prevent mode crossover into constant current.

### Positive and Negative Voltages

Either positive or negative voltages with respect to ground can be obtained from the output by grounding (or "commoning") one of the output terminals. Always use two wires to connect the load to the output regardless of where or how the system is grounded. The power supply can be operated with any output terminal  $\pm 240$  VDC including output voltage from ground.

#### NOTE

The APS models are optimized for grounding the negative output terminal. Grounding the positive terminal may result in increased current measurement noise and a reduction in current measurement accuracy.

# Parallel Connections

### Parallel Description

### Sharing Cable Fabrication

### Load, Sense, and Sharing Connections

## Parallel Description

Connecting power supplies in parallel provides a greater current capability than can be obtained from a single unit. The use of current sharing is highly recommended (for further information refer to **Current Sharing Operation**). Note that units can be operated in parallel without using the current sharing function, but the output current will not be shared equally and constant voltage mode operation may not be maintained on all units.

**CAUTION****To Prevent Possible Equipment Damage:**

- Connect no more than five units **of identical voltage ratings** in parallel.
- Do not parallel N6900 models with N7900 models.
- Always connect the **negative** output terminals of all current-sharing units together to prevent damaging the Sharing bus.
- Always turn the **AC power** on and off together. Never leave any units powered on while the others are turned off.

If AC power is turned on or off on a single coupled unit, the outputs of the remaining units that are still powered on will be enabled and will transition to their programmed settings. To prevent this from happening, program the outputs of all coupled units to zero before powering them off, and always turn AC power on or off together on all coupled units.

Current sharing considerations:

- The **Sharing** terminals must be connected for current sharing operation as shown in the figure under Load, Sense, and Sharing Connections. If the Sharing cable is disconnected, the paralleled units will still operate, but will not share current or maintain constant voltage mode operation.
- Do not use local sensing if there can be a voltage drop greater than 0.5% of the voltage rating of the units as measured from the local sense points of any unit to the local sense points of any other paralleled unit. Use remote sensing as shown under Load, Sense, and Sharing Connections.
- Turn the outputs on and off together for clean output on/off operation. It is recommended to use the digital I/O pins to couple the output turn-on/turn-off transitions between the units as described under **Output Sequence Control**.
- When units are configured with output coupling enabled, the voltage on all units should be programmed to zero volts prior to turning off AC power.

- Units of mixed power (1 kW and 2 kW) with the same voltage rating can participate in current sharing. This lets you take advantage of the higher current capability of the 2 kW units.

### Sharing Cable Fabrication

A connector plug is supplied with each unit, but the cable itself must be fabricated. You must provide the cable wiring. The following figure illustrates the cable assembly. Note that pin 1 is not used. Briefly:

- Keep wire size around AWG 20 or 22 (0.5 mm<sup>2</sup>).
- Strip wire insulation back 7 mm.
- Insert the wires into the connector and tighten the screw terminal.
- Twist or bundle the wires to reduce noise. Shielding is not required.
- Connect pins 2 together; connect pins 3 together.



### Load, Sense, and Sharing Connections

The following figure shows how to connect three units in parallel. Note the following recommendations:

- Install the paralleled units relatively close to each other in a stacked configuration.
- Bus bars can be used instead of cables to parallel the output terminals in a stacked configuration. Place the bus bars on the inside of the output terminals.
- Keep the wiring from the power supplies to the load as short as possible and twist or bundle the leads to reduce lead inductance and noise pickup. The goal is to always minimize the loop area or physical space between the + and - output leads from the power supply to the load.
- If the units cannot be located close together, a symmetrical arrangement of separate load-wire pairs of equal length connecting to a common load point is highly recommended. This provides the best possible dynamic response.
- Connect the sense leads of each paralleled unit directly to the load.

Although the following figure shows the recommended use of remote sensing, local sensing may be used if absolutely necessary. However, with local sensing, the sharing circuits will work properly only if the voltage drop measured *between* the local sense points of any unit to the local sense points of any other paralleled unit is less than 0.5% of the maximum voltage rating of the units.

## 2 Installing the Instrument

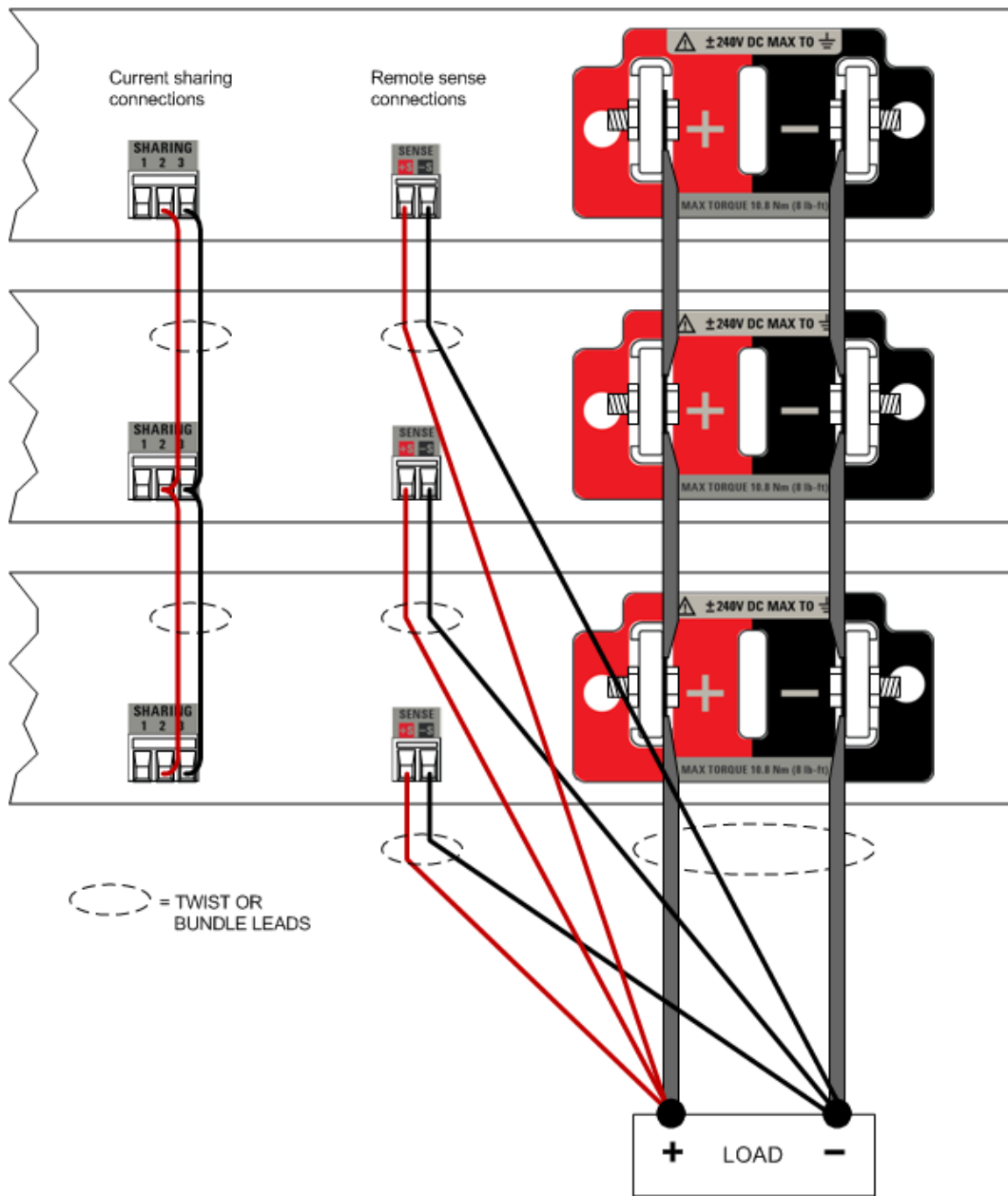

## Series Connections

### Series Description

### Load, Sense, and Diode Connections

### Series Diode Considerations

### Capacitance Limits

### Additional Cautions When Using a Boost Supply in Series

## Series Description

Connecting power supplies in series provides a greater voltage capability than can be obtained from a single unit. Note the following important considerations:

- If your device under test does not have any energy sourcing ability such as a battery, power supply, or large energy storage device, the power supplies can be connected and operated in series. Observe all applicable warnings and cautions (see below).
- If your device under test includes a small capacitance, it may be acceptable to connect power supplies in series in most cases. Refer to the **Capacitance Limits** table at the end of this section for detailed information.
- Always use series connections **with a series protection diode** when devices such as large capacitors, power supplies, batteries, or any other energy sources that may force current back into the power supply are connected to the output. This diode protects the units from damage due to reverse current as described under **Series Diode Considerations**. If using the series diode is not acceptable in your application, please contact Keysight Technologies to speak to a power product support engineer for assistance.

The following warnings and cautions must be followed in all cases:

#### WARNING

**SHOCK HAZARD** Floating voltages must not exceed 240 VDC. No output terminal may be more than 240 VDC from chassis ground.

#### CAUTION

**To Prevent Possible Equipment Damage:**

- Only connect units of **identical voltage and current ratings** in series.
- Do not connect N6900 models with N7900 models.
- Lock the **output relays** closed on models that include them. Output relays are not rated to switch voltages higher than the individual instrument rating.
- Always turn the **AC power** on and off together. Never leave any units powered on while the others are off.

## 2 Installing the Instrument

- For 40V, 60V, 80V, 120V and 160V N6900 models **without** relay disconnect option 760 or 761, all outputs must be turned off on all series-connected units before AC power is turned off on any of the units.
- Always turn the outputs on and off together. It is recommended to use the digital I/O pins to couple the output turn-on/turn-off transitions between the units as described under **Output Sequence Control**.
- Always program identical voltage settings on all units, and synchronize the voltage up and down programming across units.
- Set the **positive current limit** to identical values on all series-connected units.
- Set the **negative current limit** to its **most negative** value, thus allowing each instrument maximum capability to protect itself and balance the voltages.
- Couple the output protection systems of the series-connected units as described under **Fault/Inhibit System Protection**. This prevents uneven voltage sharing between units if one or more shut down due to a fault condition.
- If the current Sharing cables are connected, do not enable current sharing under any circumstances or the power supply may be damaged. Refer to **Enable Current Sharing** to disable. To protect the unit in case the current sharing function is accidentally enabled, you should physically disconnect the current sharing cable from the back of the unit.
- Do not use the N7909A power dissipator when connecting power supplies in series. Series connections are not allowed if the power supplies are being used to sink current.

### Load, Sense, and Diode Connections

The following figure shows how to connect three units in series. Note the following recommendations:

- To guarantee protection from reverse currents in all cases, it is recommended to always connect a series diode in line with your load as shown.
- Install the units relatively close to each other in a stacked configuration.
- Keep the wiring from the power supplies to the load as short as possible and twist or bundle the leads to reduce lead inductance and noise pickup. The goal is to always minimize the loop area or physical space between the + and - output leads from the power supply to the load.
- If the series diode is being used, connect the sense leads as shown below. Without the diode, connect the +s lead directly to the load.

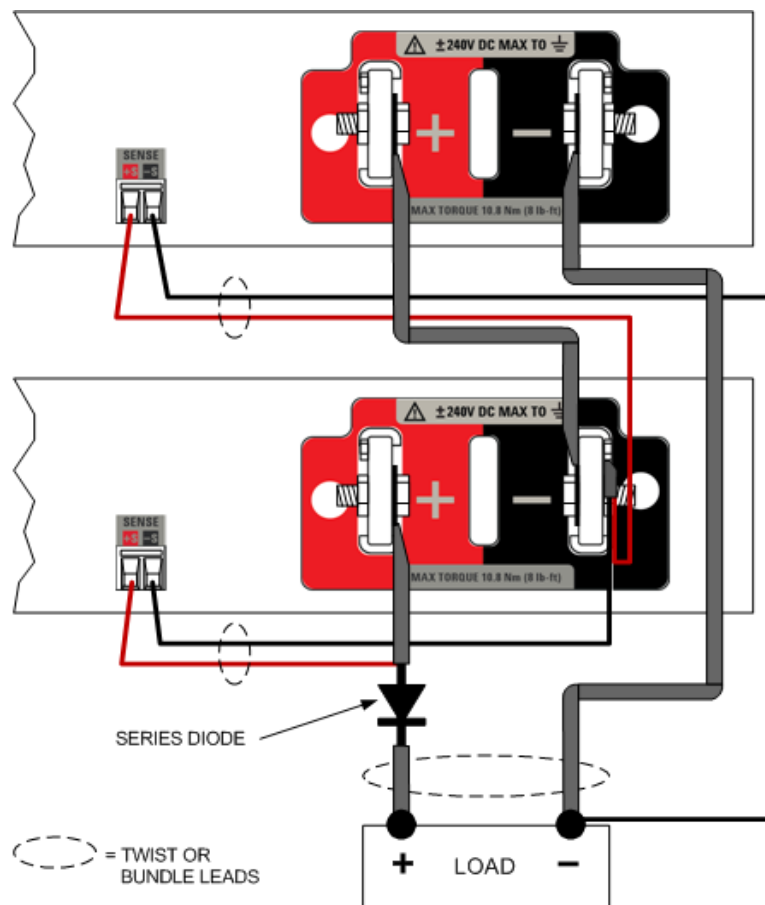

### Series Diode Considerations

The series diode protects the power supplies by isolating the potentially harmful external energy source from the power supply outputs, thereby completely eliminating the risk of instrument damage due to reverse currents. The use of the protection diode will not allow current-sinking operation. The power supplies will not be able to down-program the voltage at the load, nor can they act as a load.

The series diode needs to have a reverse voltage rating of at least the sum of the voltage ratings of all the series-connected units. Allow an appropriate margin for voltage overshoots and for the maximum current rating of the series-connected units.

As shown in the figure, the + sense lead of the end unit must be connected to the anode (the power supply side) of the diode, and not to the cathode (the load side) to protect the sense leads from possible damage. Note that this will degrade the voltage regulation and programming accuracy at the load.

To improve programming accuracy, use a DMM to measure the voltage at the load and programmatically compensate for the voltage drop across the diode by adjusting the output voltage of the power supplies. The diode drop will vary depending on output current and temperature.

#### NOTE

If using the series diode is not acceptable in your application, please contact Keysight Technologies to speak to a power product support engineer for assistance.

### Capacitance Limits

The following table describes the maximum load capacitance that can be tolerated in a series configuration. If you suspect that your load capacitance exceeds these values, you must install the series diode as previously described.

1 kW Models in series	Maximum load capacitance with 2 units in series	2 kW Models in series	Maximum load capacitance with 2 units in series
N6950A/N7950A	381 $\mu$ F	N6970A/N7970A	763 $\mu$ F
N6951A/N7951A	94 $\mu$ F	N6971A/N7971A	188 $\mu$ F
N6952A/N7952A	23 $\mu$ F	N6972A/N7972A	46 $\mu$ F
N6953A/N7953A	11 $\mu$ F	N6973A/N7973A	22 $\mu$ F
N6954A/N7954A	6 $\mu$ F	N6974A/N7974A	12 $\mu$ F
		N6976A/N7976A	5.5 $\mu$ F
		N6977A/N7977A	3 $\mu$ F

### Additional Cautions When Using a Boost Supply in Series

The following cautions only apply to 40V, 60V, 80V, 120V and 160V N6900 models **without** relay disconnect option 760 or 761.

**CAUTION**

**To Prevent Possible Equipment Damage:**

- Do not power up the boost supply until after the APS is turned on and initialized.
- Turn off the boost supply first; then turn off the APS unit.

The following figure illustrates how a boost supply is typically connected.

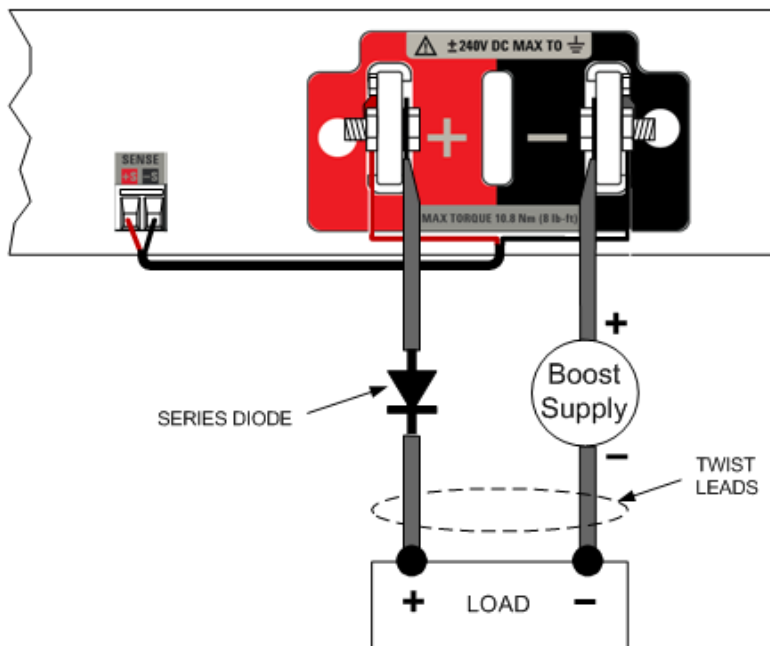

## Power Dissipator Connections

### The N7909A Power Dissipator

#### Power Cable Fabrication

#### Power Dissipator Connections - 1 kW Units

#### Power Dissipator Connections - 2 kW Units

### The N7909A Power Dissipator

The N7909A power dissipator is required to provide 100% of the rated current-sink capability of the APS models. For further information about current sinking, refer to [Current Sinking Operation](#).

The dimensions of your power dissipator as well as an outline diagram are given under [Specifications](#). Fans cool the power dissipator by drawing air through the sides and exhausting it out the back. Do not block the air intake at the sides of the instrument or the exhaust at the rear of the instrument. Additional installation requirements are as follows:

- Only install the power dissipator in a location that allows sufficient space of at least 50 mm (2 inches) at the sides and back of the unit for adequate air circulation.
- The power dissipator may be located anywhere near the power supply (above, below, or adjacent), as long as the power dissipator is physically located within 1 meter of the power supply.
- Turn off the power supply before connecting any power dissipator units. The power dissipator is discovered at power-on and is automatically enabled.
- Use only the supplied CAT6A cable for the interface connections. Snap the cable into the **P2** connectors. When installing a second power dissipator on 2 kW units, connect the second CAT6A cable into the **P4** connector on the power supply. Do not use other LAN cables as they will not work properly. The supplied CAT6A cable is shielded and uses the shield as a conductor.

#### CAUTION

Never plug the CAT6A cable into the LAN connector, or the unit will be damaged.

- Use the fabricated power cable for the power (P1) connections (see below). Snap the cable into the **P1** connectors. When installing a second power dissipator on 2 kW units, connect the second power cable into the **P3** connector on the power supply.

### Power Cable Fabrication

Two end-connectors are included with the power dissipator. You must provide the cable wiring. The following illustration provides assembly details. Briefly:

- Keep wire length to one meter or less, or the power supply will not meet its published specifications.

## 2 Installing the Instrument

- Keep wire size between AWG 10 (6 mm<sup>2</sup>) maximum and AWG 14 (2.5 mm<sup>2</sup>) minimum. Wires must carry currents of up to 15 A.
- Strip wire insulation back 15 mm.
- Push the wire straight into the oval opening (1). Observe polarity.
- Twist or bundle the wires to reduce noise.
- To release the wire, insert a small screwdriver into the square release-tab opening (2).
- To release the connector from the unit, push both orange release tabs in together (3) and pull back on the plug.

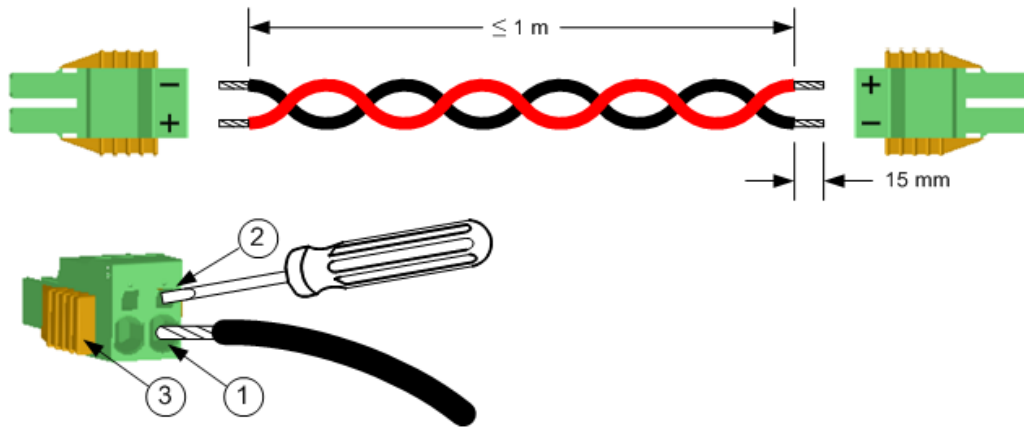

## Power Dissipator Connections - 1 kW Units

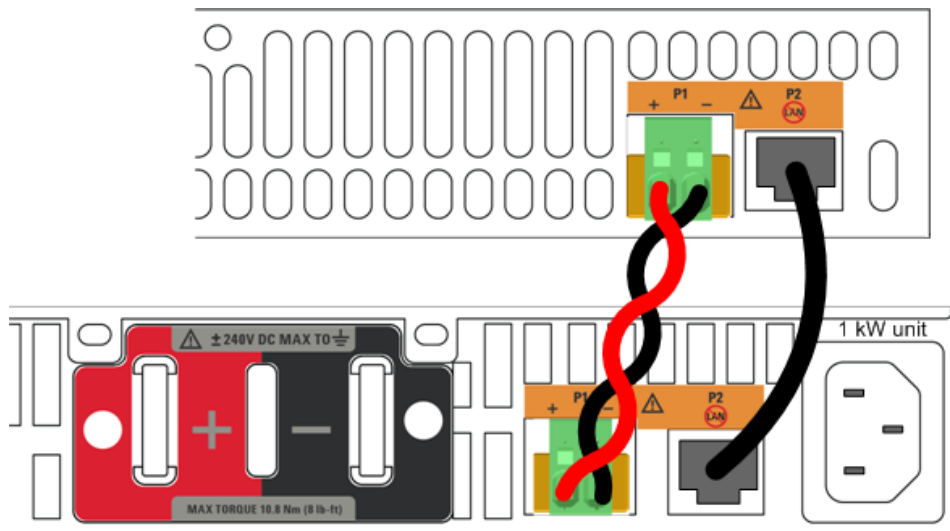

## Power Dissipator Connections - 2 kW Units

**NOTE**

If you are using only one power dissipator with your 2 kW power supply, it does not matter if you are connecting to the upper or lower connectors. In this case, you will only be able to dissipate up to 1 kW of output power.

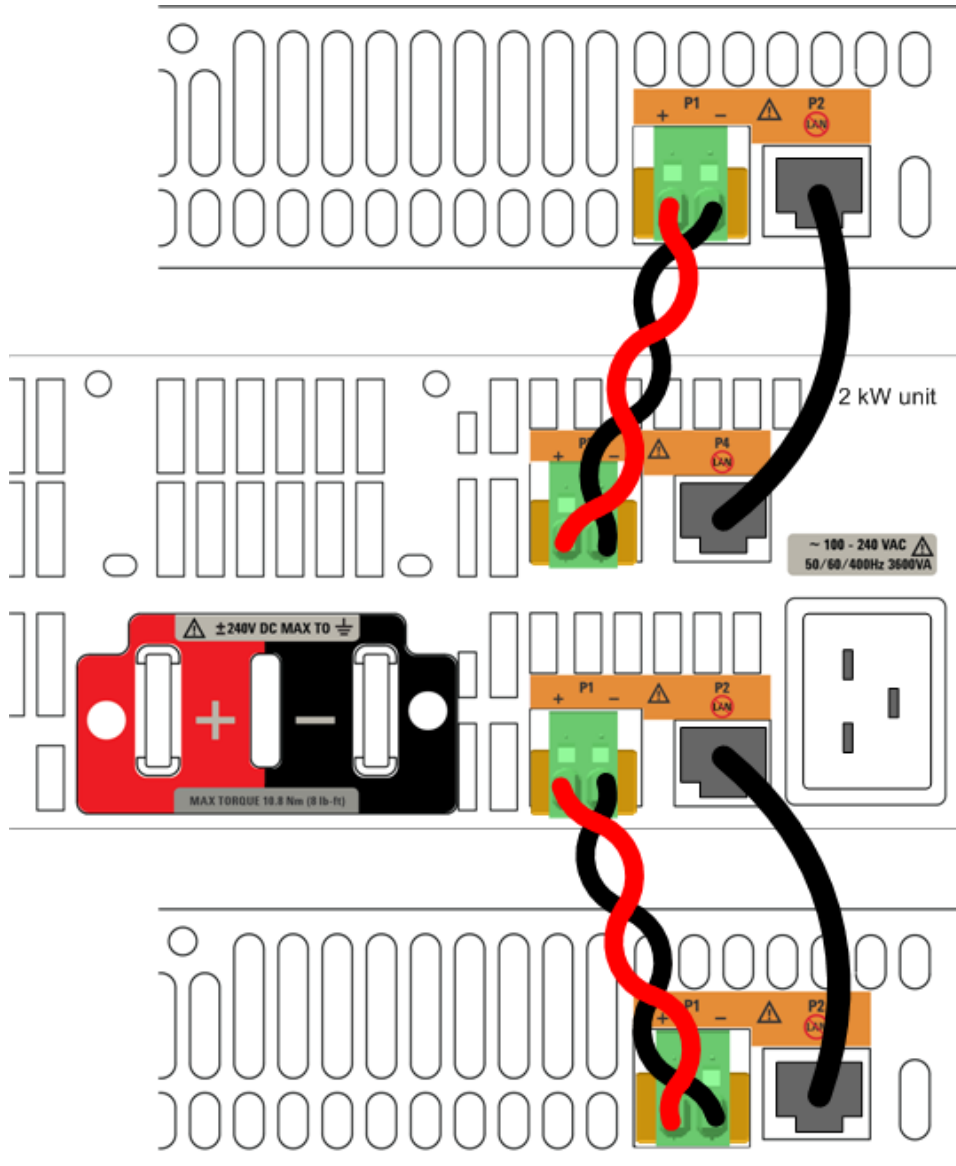

## Interface Connections

### GPIB Connections

### USB Connections

### LAN Connections - site and private

### Digital Port Connections

This section describes how to connect to the various communication interfaces on your APS. For further information about configuring the remote interfaces, refer to [Remote Interface Configuration](#).

If you have not already done so, install the Keysight IO Libraries Suite from the Automation-Ready CD that is shipped with your instrument.

**NOTE**

For detailed information about interface connections, refer to the Keysight USB/LAN/GPIB Interfaces Connectivity Guide, located on the Automation-Ready CD.

## GPIB Connections

The following figure illustrates a typical GPIB interface system.

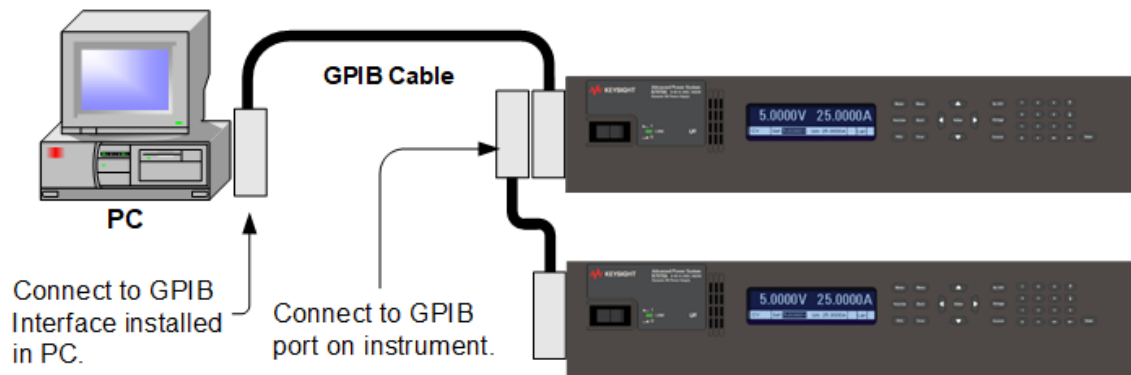

1. Connect your instrument to the GPIB interface card using a GPIB interface cable.
2. Use the Connection Expert utility of the Keysight IO Libraries Suite to configure the GPIB card's parameters.
3. You can now use Interactive IO within the Connection Expert to communicate with your instrument, or you can program your instrument using the various programming environments.

## USB Connections

The following figure illustrates a typical USB interface system.

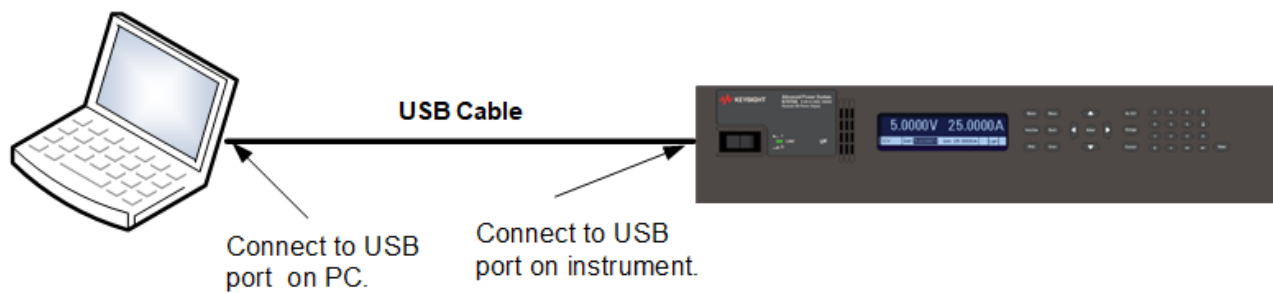

1. Connect your instrument to the USB port on your computer.
2. With the Connection Expert utility of the Keysight IO Libraries Suite running, the computer will automatically recognize the instrument. This may take several seconds. When the instrument is recognized, your computer will display the VISA alias, IDN string, and VISA address. This information is located in the USB folder.
3. You can now use Interactive IO within the Connection Expert to communicate with your instrument, or you can program your instrument using the various programming environments.

### LAN Connections - site and private

A site LAN is a local area network in which LAN-enabled instruments and computers are connected to the network through routers, hubs, and/or switches. They are typically large, centrally-managed networks with services such as DHCP and DNS servers. The following figure illustrates a typical site LAN system.

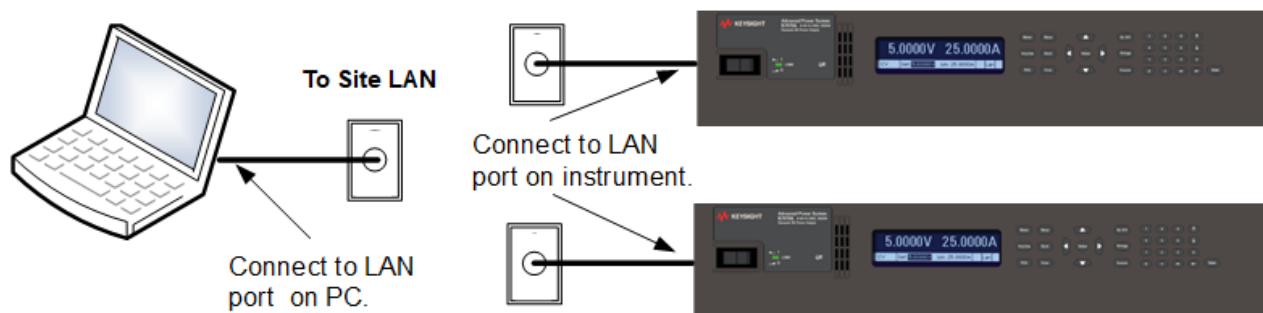

A private LAN is a network in which LAN-enabled instruments and computers are directly connected, and not connected to a site LAN. They are typically small, with no centrally-managed resources. The following figure illustrates a typical private LAN system.

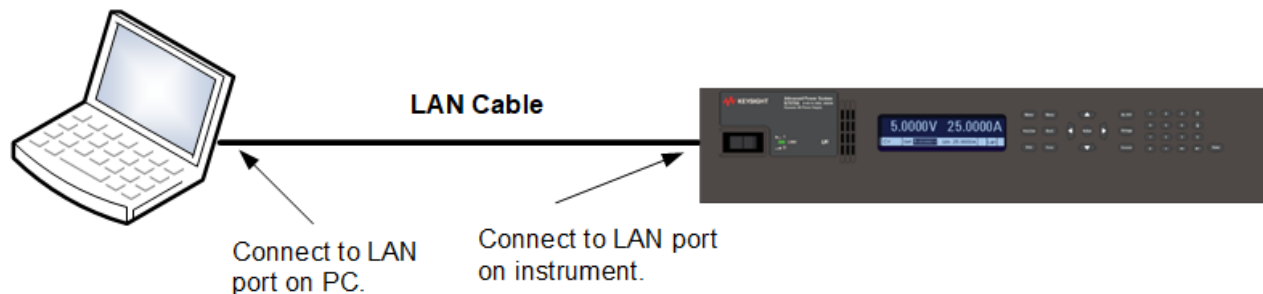

## 2 Installing the Instrument

1. Connect the instrument to the site LAN or to your computer using a LAN cable. The as-shipped instrument LAN settings are configured to automatically obtain an IP address from the network using a DHCP server (DHCP is set On). The DHCP server will register the instrument's hostname with the dynamic DNS server. The hostname as well as the IP address can then be used to communicate with the instrument. If you are using a private LAN, you can leave all LAN settings as they are. Most Keysight products and most computers will automatically choose an IP address using auto-IP if a DHCP server is not present. Each assigns itself an IP address from the block 169.254.nnn. The front panel **Lan** indicator will come on when the LAN port has been configured.
2. Use the Connection Expert utility of the Keysight IO Libraries Suite to add the APS models and verify a connection. To add the instrument, you can request the Connection Expert to discover the instrument. If the instrument cannot be found, add the instrument using the instrument's host-name or IP address.
3. You can now use Interactive IO within the Connection Expert to communicate with your instrument, or you can program your instrument using the various programming environments. You can also use the Web browser on your computer to communicate with the instrument as described under [Using the Web Interface](#).

### Digital Port Connections

#### NOTE

It is good engineering practice to twist and shield all signal wires to and from the digital connector. If shielded wire is used, connect only one end of the shield to chassis ground to prevent ground loops.

An 8-pin connector and a quick-disconnect connector plug are provided for accessing the digital port functions. Disconnect the connector plug to make your wire connections. The connector plug accepts wires sizes from AWG 14 (1.5 mm<sup>2</sup>) to AWG 28 (0.14 mm<sup>2</sup>). Wire sizes smaller than AWG 24 (0.25 mm<sup>2</sup>) are not recommended. Strip wire insulation back 7 mm.

1. Insert wires
2. Tighten screws
3. Fault/Inhibit configurable pins (observe INH polarity)
4. Output Couple configurable pins
5. Digital IO-configurable or Expression-configurable pins
6. Signal common

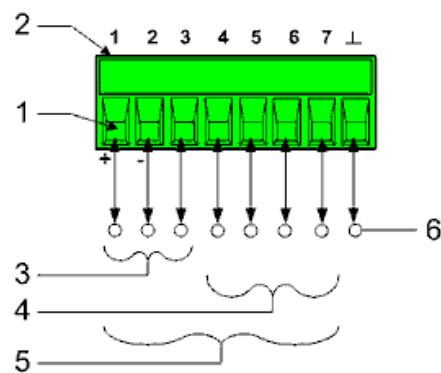

Information on using the digital port is found under [Programming the Digital Port](#). The electrical characteristics are described under [Common Characteristics](#).

## Rack Mounting

This section contains information for installing an N7910A Rack Mount Kit (dark grey). This rack mount kit allows the 1 kW and 2 kW power supplies as well as the power dissipator to be mounted in a 19-inch EIA rack cabinet. It replaces the previous N7907A Rack Mount Kit (light grey).

Before getting started, check the following list and verify that you have received these items. If anything is missing, please contact your nearest Keysight Sales and Support Office.

Items Supplied	Keysight N7910A part number
2 pair – Slide rails	5003-1128
2 – 1U rack ears for 1kW units or power dissipator units	5003-2347
2 – 2U rack ears for 2kW units	1CM110A
8 – Clip-nuts for attaching to rack frame (10-32)	0590-0804
4 – Fixed slide attachment screws (10-32 x 0.5)	2680-0104
4 – Movable slide attachment screws (M4 x 12 mm)	0515-1013
6 – Front ear attachment screws (M3 x 8 mm)	0515-0372
4 – Front dress screws (10-32 x 0.625)	3030-1768

## Installing the Instrument

### CAUTION

Do not block the air intake at the sides of the instrument or the exhaust at the rear of the instrument.

You cannot use standard support rails for rack mounting your instrument as they would block the airflow needed for cooling.

Tools required: Phillips driver, T22 Torx driver, T10 Torx driver.

1. Install eight clip-nuts on the rack frame where your instrument will be located. As shown in the illustration, install three on each front corner; and one on each rear corner.
2. Separate the pieces of each slide rail pair and install the stationary part of each slide to the two clip nuts on the sides of the instrument rack using the four fixed slide rail screws provided.
3. Install the movable part of each slide to the sides of the instrument using the four movable slide rail screws provided. Use location (3a) for the 1 kW units; location (3b) for the 2 kW units, and location (3c) for the power dissipator unit.
4. Install the front panel ears to the instrument using the six front ear screws provided.
5. Slide the instrument into the rack.
6. Attach the front ears to the instrument rack using the four front dress screws provided.

## 2 Installing the Instrument

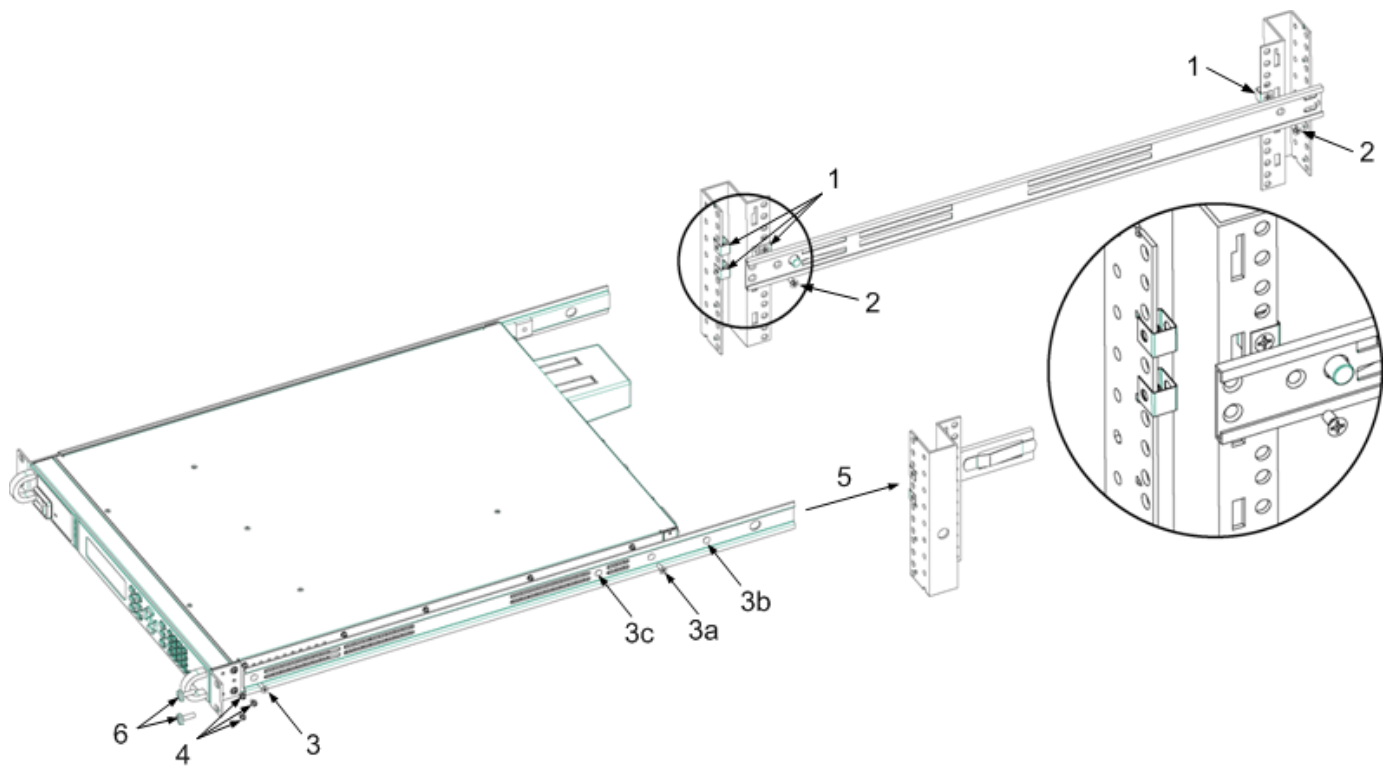

### Rack Mounting

## Black Box Recorder

### NOTE

This procedure only applies to instruments with serial number prior to MY59100101 (refer to [Firmware Updates](#)).

On units with later serial numbers MY59100101 and up, the BBR function is integrated on the processor board and can only be ordered as a factory-installed **Option BBR**. These units do not have an access cover located on the bottom of the chassis as described in this section.

On units with prior serial numbers, the N7908A Black Box Recorder accessory board installs in an access port on the bottom of the chassis. The following installation procedure applies to these units.

Refer to [Black Box Data Recording](#) for information about using the Black Box Recorder.

## Installing the BBR

### CAUTION

Turn off the instrument, remove the power cord, and turn the unit over. Observe all precautions for handling electrostatic discharge sensitive devices when installing the BBR board.

1. Remove the access cover by loosening the two screws.
2. Position the BBR board with the connector facing down and snap it into the unit.
3. Replace the access cover and tighten the screws..
4. Check the box labeled "Black Box Recorder" on top of the unit to indicate that the BBR option is installed.

### NOTE

If the BBR drive has been removed from the instrument, refer to [BBR Status](#) for more information.

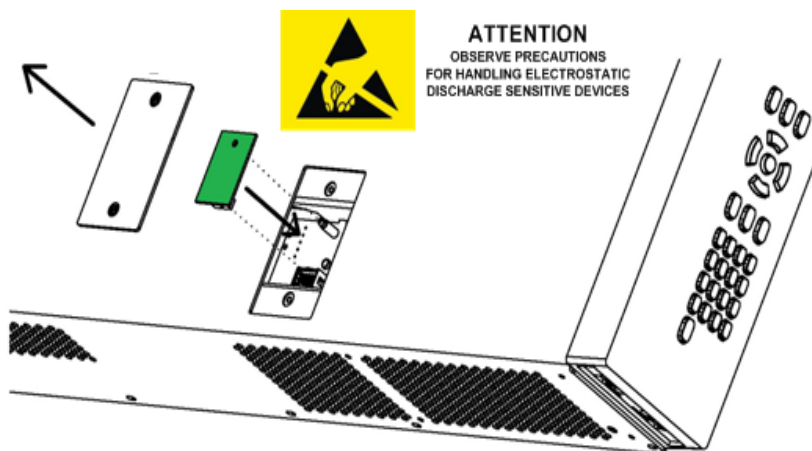

# 3

## Getting Started

**Using the Front Panel**

**Remote Interface Configuration**

## Using the Front Panel

**Turn the Unit On**

**Set the Output Voltage**

**Set the Output Current**

**Set Over-voltage Protection**

**Enable the Output**

**Use Built-in Help System**

### Turn the Unit On

Verify that the line cord is connected and plugged in.

Turn the unit on with the front panel power switch. The front panel display will light up after a few seconds. A power-on self-test occurs automatically when you turn the unit on. This test assures you that the power supply is operational.



**NOTE**

It may take 30 seconds or so for the power supply to initialize before it is ready to use.

If the instrument does not turn on, verify that the power cord is firmly connected (power-line voltage is automatically sensed at power-on). Also make sure that the instrument is connected to an energized power source. If the LED next to the power switch is off, there is no AC power connected. If the LED is amber, the instrument is in standby mode with AC power connected; if green, the instrument is on.

If a self-test error occurs, a message is displayed on the front panel. If the message "Drive failed" appears, refer to **Black Box Data Recording**. For other self-test errors, see **Service and Maintenance** for instructions on returning the instrument for service.

### Set the Output Voltage

#### Method 1

Use the left and right navigation keys to navigate to the setting that you wish to change.

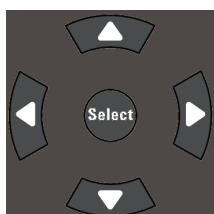

In the following display, the voltage setting is selected. Enter a value using the numeric keypad. Then press **Select**.



You can also use the numeric arrow keys to adjust the value up or down. Values become effective when the output is turned on.

In voltage priority mode, the unit will maintain the output voltage at its programmed setting. In current priority mode, the unit will limit the output voltage when it reaches the specified voltage limit value. Refer to **Set the Output Mode** for more information.

## Method 2

Use the **Voltage** key to select the voltage entry field. In the display below, the voltage setting is selected. Enter the desired setting using the numeric keypad. Then press **Enter**.



If you make a mistake, either use the backspace key to delete the number, press **Back** to back out of the menu, or press **Meter** to return to meter mode.

## Set the Output Current

### Method 1

Use the left and right navigation keys to navigate to the setting that you wish to change.

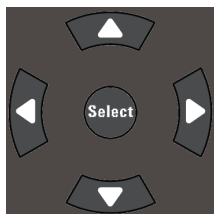

In the display below, the current setting is selected. Use the up and down navigation keys to toggle between the + and - limit entries. Enter a value using the numeric keypad. Then press **Select**.



You can also use the numeric arrow keys to adjust the value up or down. You can set both positive and negative current values. Values become effective when the output is turned on.

In current priority mode, the unit will maintain the output current at its programmed setting. In voltage priority mode, the unit will limit the output current when it reaches the specified current limit value. Refer to [Set the Output Mode](#) for more information.

## Method 2

Use the **Current** key to select the current entry field. In the display below, the current setting is selected. Enter the desired setting using the numeric keypad. Then press **Enter**.

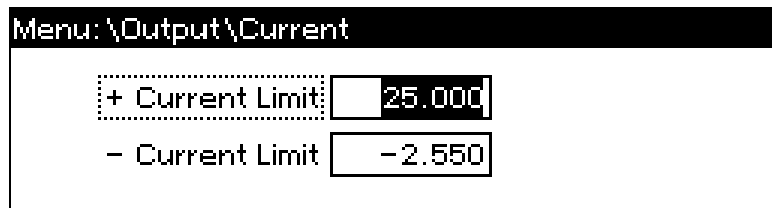

If you make a mistake, either use the backspace key to delete the number, press Back to back out of the menu, or press Meter to return to meter mode.

## Set Over-voltage Protection

### Use the front panel menu.

The front panel command menu lets you access most of the instrument's functions. The actual function controls are located at the lowest menu level. Briefly:

- Press the **Menu** key to access the command menu.
- Press the left and right (<, >) navigation keys to move across the menu commands.
- Press the center **Select** key to select a command and move down to the next level in the menu.
- Press the **Help** key at the lowest menu level to display help information about the function controls.
- To exit the command menu press the **Meter** key to immediately return to meter mode, or press the **Menu** key to return to the top level.

For a map of the front panel menu commands, refer to [Front Panel Menu Reference](#).

### Menu example - accessing over-voltage protection.

Press the **Menu** key to access the front panel command menu. The first line identifies the menu path. When the menu is first accessed, the menu is at the top or root, and the path is empty. The second line indicates the commands that are available at the present menu level. In this case, the top-level menu commands are shown, with the Output command highlighted. The third line indicates which commands are available under the Output command. If there are no lower level commands, a brief description of the highlighted command is displayed.

```
Menu: \
Output Measure Transient Protect States System
Voltage, Current, Mode, Sequence, Advanced
```

Press the right arrow navigation key > to traverse the menu until the Protect command is highlighted. Press the **Select** key to access the Protect commands.

```
Menu: \
Output Measure Transient Protect States System
OVP, OCP, Inhibit, WDog, SFD, Mode, Clear
```

Since the OVP command is already highlighted, press the Select key to access the OVP dialog.

```
Menu: \Protect
OVP OCP Inhibit WDog SFD Mode Clear
Overvoltage protection settings.
```

Note that the OVP setting for this model is set to 24 V. You can change the OVP setting using the numeric entry keys and pressing **Enter** and **Select**. Press the **Meter** key to return to meter view.

```
Menu: \Protect\OVP
OVP Level: 24.00
```

### Enable the Output

Use the **On/Off** key to enable the output. If a load is connected to the output, the front panel display will indicate that it is drawing current. Otherwise, the current reading will be zero. The status indicator shows the output's status. In this case, "CV" indicates the output is in constant voltage mode.



For a description of the status indicators, refer to [Front Panel Display at a Glance](#).

## Use Built-in Help System

### View the list of help topics.

Press the **Help** key to view the list of available help topics. To scroll through the list, press the up and down navigation arrows.

Press **Meter** or **Back** to exit Help.

### View the help information for displayed messages.

Whenever a limit is exceeded or any other invalid configuration is found, the instrument will display a message, including Error code information.

Press **Meter** or **Back** to exit Help.

## Remote Interface Configuration

**USB Configuration**

**GPIB Configuration**

**LAN Configuration**

**Modifying the LAN Settings**

**Using the Web Interface**

**Using Telnet**

**Using Sockets**

**Interface Lockout**

### Introduction

This instrument supports remote interface communication over three interfaces: GPIB, USB, and LAN. All three interfaces are "live" at power up. To use the interfaces, you must first install the Keysight IO Libraries software located on the Keysight Automation-Ready CD provided with your instrument. Then connect your instrument to your PC.

The front panel **IO** indicator comes on whenever there is activity on the remote interfaces. The front panel **Lan** indicator comes on when the LAN port is connected and configured.

This instrument provides Ethernet connection monitoring. With Ethernet connection monitoring, the instrument's LAN port is continually monitored, and automatically reconfigured when the instrument is unplugged for a minimum of 20 seconds and then reconnected to a network.

### USB Configuration

There are no configurable USB parameters. You can retrieve the USB connect string using the front panel menu:

Front Panel Menu Reference	SCPI Command
Select <b>System\IO\USB</b> The dialog displays the USB connect string.	Not available

### GPIB Configuration

Each device on the GPIB (IEEE-488) interface must have a unique whole number address between 0 and 30. The instrument ships with the address set to 5. Your computer's GPIB interface card address must not conflict with any instrument on the interface bus. This setting is non-volatile; it will not be changed by power cycling or \*RST. Use the front panel menu to change the GPIB address:

### 3 Getting Started

Front Panel Menu Reference	SCPI Command
Select <b>System\IO\GPIB</b> .  Use the numeric keys to enter a new value from 0 to 30. Then press <b>Enter</b> .	Not available

## LAN Configuration

The following sections describe the primary LAN configuration functions on the front-panel menus. Note that there are no SCPI commands to configure the LAN parameters. All LAN configuration must be done from the front panel.

### NOTE

After changing the LAN settings, you must Save the changes. Select: **System\IO\LAN\Apply**. Selecting Apply cycles power to the instrument and activates the settings. LAN settings are non-volatile, they will not be changed by power cycling or \*RST. If you do not want to save your changes select: **System\IO\LAN\Cancel**. Selecting Cancel cancels all changes.

When shipped, DHCP is on, which may enable communication over LAN. The letters DHCP stands for Dynamic Host Configuration Protocol, a protocol for assigning dynamic IP addresses to devices on a network. With dynamic addressing, a device can have a different IP address every time it connects to the network.

## Viewing Active Settings

To view the currently active LAN settings:

Front Panel Menu Reference	SCPI Command
Select <b>System\IO\LAN\Settings</b> .  Displays the active LAN settings. Use the up and down arrow key to scroll through the list.	Not available

The currently active settings for the IP Address, Subnet Mask, and Default Gateway may be different from the front panel configuration menu settings - depending on the configuration of the network. If the settings are different, it is because the network has automatically assigned its own settings

## Resetting the LAN

You can perform an LXI LCI reset if the LAN settings. This resets DHCP, DNS server address configuration, mDNS state, mDNS service name and web password. These settings are optimized for connecting your instrument to a site network. They should also work well for other network configurations.

You can also reset the LAN to the as-shipped settings. This returns **ALL** LAN settings to the as-shipped values and restarts networking. All default LAN settings are listed under **Non-volatile Settings**.

Front Panel Menu Reference	SCPI Command
Select <b>System\IO\LAN\Reset</b>	Not available
Select <b>System\IO\LAN\Defaults</b>	
Select <b>Reset</b> .	
Selecting <b>Reset</b> activates the selected LAN settings and restarts networking.	

## Modifying the LAN Settings

### IP Address

Select **IP** to configure the addressing of the instrument. Press the **Menu** key, then select **System\IO\LAN\Config\IP**. The configurable parameters include:

Front Panel Menu Reference	SCPI Command
Select <b>System\IO\LAN\Modify\IP</b>	Not available
Select <b>Auto</b> or <b>Manual</b> . See below for a full description.	

- **Auto** - automatically configures the addressing of the instrument. When selected, the instrument will first try to obtain an IP address from a DHCP server. If a DHCP server is found, the DHCP server will assign an IP address, Subnet Mask, and Default Gateway to the instrument. If a DHCP server is unavailable, the instrument will try to obtain an IP address using AutoIP. AutoIP automatically assigns an IP address, Subnet Mask, and Default Gateway addresses on networks that do not have a DHCP server.
- **Manual** - allows you to manually configure the addressing of the instrument by entering values in the following three fields. These fields only appear when **Manual** is selected.
- **IP Address** - This value is the Internet Protocol (IP) address of the instrument. An IP address is required for all IP and TCP/IP communications with the instrument. An IP Address consists of 4 decimal numbers separated by periods. Each decimal number ranges from 0 through 255 with no leading zeros (for example, 169.254.2.20).
- **Subnet Mask** - This value is used to enable the instrument to determine if a client IP address is on the same local subnet. The same numbering notation applies as for the IP Address. When a client IP address is on a different subnet, all packets must be sent to the Default Gateway.
- **DEF Gateway** - This value is the IP Address of the default gateway that allows the instrument to communicate with systems that are not on the local subnet, as determined by the subnet mask setting. The same numbering notation applies as for the IP Address. A value of 0.0.0.0 indicates that no default gateway is defined.

Dot-notation addresses ("nnn.nnn.nnn.nnn" where "nnn" is a byte value from 0 to 255) must be expressed with care, as most PC web software interprets byte values with leading zeros as octal (base 8) numbers. For example, "192.168.020.011" is actually equivalent to decimal "192.168.16.9" because ".020" is interpreted as "16" expressed in octal, and ".011" as "9". To avoid confusion, use only decimal values from 0 to 255, with no leading zeros.

## Host Name

A hostname is the host portion of the domain name, which is translated into an IP address. To configure the hostname of the instrument:

Front Panel Menu Reference	SCPI Command
Select <b>System\IO\LAN\Modify\Name</b>	Not available
<p>You can enter any value from the numeric keypad. For additional characters, use the up/down navigation keys to enter an alpha character by scrolling through the selection list that appears when you press the keys. Use the left/right navigation keys to traverse the text field. Use the backspace key to delete a value. Press Enter when you are finished.</p>	

**Host Name** - This field registers the supplied name with the selected naming service. If the field is left blank, no name is registered. A hostname may contain upper and lower case letters, numbers and dashes (-). The maximum length is 15 characters.

Each instrument is shipped with a default hostname with the format: A-modelnumber-serialnumber, where modelnumber is the unit's 6-character model number (e.g. N6950A), and serialnumber is the last five characters of the 10-character serial number located on the label on the top of the unit (e.g. 45678 if the serial number is MY12345678).

## DNS Server and WINS Server

DNS is an internet service that translates domain names into IP addresses. It is also needed for the instrument to find and display its hostname assigned by the network. Normally, DHCP discovers the DNS address information; you only need to change this if DHCP is unused or not functional.

WINS configures the Windows service of the instrument. This is similar to the DNS service that translates domain names into IP addresses.

To manually configure the DNS and WINS services:

Front Panel Menu Reference	SCPI Command
Select <b>System\IO\LAN\Modify\DNS</b> or Select <b>System\IO\LAN\Modify\WINS</b>	Not available
<p>Select Primary Address or Secondary Address. See below for a full description.</p>	

- **Primary Address** - This field enters the primary address of the server. Contact your LAN administrator for server details. The same numbering notation applies as for the IP Address. A value of 0.0.0.0 indicates that no default server is defined.
- **Secondary Address** - This field enters the secondary address of the server. Contact your LAN administrator for server details. The same numbering notation applies as for the IP Address. A value of 0.0.0.0 indicates that no default server is defined.

Dot-notation addresses ("nnn.nnn.nnn.nnn" where "nnn" is a byte value from 0 to 255) must be expressed with care, as most PC web software interprets byte values with leading zeros as octal (base 8) numbers. For example, "192.168.020.011" is actually equivalent to decimal "192.168.16.9" because ".020" is interpreted as "16" expressed in octal, and ".011" as "9". To avoid confusion, use only decimal values from 0 to 255, with no leading zeros.

## mDNS Service Name

The mDNS service name is registered with the selected naming service. To configure the mDNS service name of the instrument:

Front Panel Menu Reference	SCPI Command
Select <b>System\IO\LAN\Modify\mDNS</b>	Not available
<p>You can enter any value from the numeric keypad. For additional characters, use the up/down navigation keys to enter an alpha character by scrolling through the selection list that appears when you press the keys. Use the left/right navigation keys to traverse the text field. Use the backspace key to delete a value. Press Enter when you are finished.</p>	

- **mDNS Service Name** - This field registers the service name with the selected naming service. If the field is left blank, no name is registered. A service name may contain upper and lower case letters, numbers and dashes(-).
- Each instrument is shipped with a default service name with the format: Keysight-modelnumber-description-serialnumber, where modelnumber is the unit's 6-character model number (e.g. N6950A), description is the description, and serialnumber is the 10-character serial number located on the label on the top of the unit (e.g. MY12345678).

## Services

This selects the LAN services to enable or disable.

Front Panel Menu Reference	SCPI Command
Select <b>System\IO\LAN\Modify\Services</b>	Not available
<p>Check or uncheck the services that you wish to enable or disable.</p>	

- The configurable services include: VXI-11, Telnet, Web control, Sockets, and mDNS.
- You must enable Web control if you wish to remotely control your instrument using its built-in Web interface.

## Using the Web Interface

Your APS has a built-in Web interface that lets you control it directly from the Web browser on your computer. With the Web interface, you can access the front panel control functions including the LAN configuration parameters. Up to six simultaneous connections are allowed. With additional connections, performance will be reduced.

**NOTE**

The built-in Web interface only operates over the LAN. It requires Internet Explorer 7+. You also need the Java Plug-in version 7+. This is included in the Java Runtime Environment.

The Web interface is enabled when shipped. To launch the Web interface:

1. Open the Web browser on your computer.
2. Enter the instrument's hostname or IP address into the browser's Address field. The following home page will appear.
3. Click on the Web Control tab on the top of the page to begin controlling your instrument.
4. For additional help about any of the pages, click on the ? icon.

KEYSIGHT TECHNOLOGIES N7954A  
Serial number: NJLP120201

Home Web Control Configure LAN ?

Connected to N7954A  
at IP address 141.121.202.132

Enable front panel identification indicator

Description

Model number	N7954A
Manufacturer	Agilent
Serial number	NJLP120201
Firmware revision	B.02.01.1255
Description	Agilent N7954A Dynamic DC Power Supply - NJLP120201

VISA instrument addresses

HISLIP LAN protocol	TCPIP::N79XX-10.local::hislip0::INSTR
VXI-11 LAN protocol	TCPIP::N79XX-10.local::inst0::INSTR
GPIB over LAN protocol	TCPIP::N79XX-10.local::gplib0,5::INSTR
TCP/IP SOCKET protocol	TCPIP::N79XX-10.local::5025::SOCKET
USB (USBTMC/488)	USB::2391::15111::NJLP120201::0::INSTR
GPIB	GPIB::5::INSTR

▼ More Information

©Keysight Technologies, Inc. 2017 | Support | Products | Keysight

If desired, you can control access to the Web interface using password protection. As shipped, no password is set. To set a password, click on the "gear" icon. Refer to the on-line help for additional information about setting a password.

## Using Telnet

In an MS-DOS Command Prompt box type: telnet hostname 5024 where hostname is the APS hostname or IP address, and 5024 is the instrument's telnet port.

You should get a Telnet session box with a title indicating that you are connected to the power supply. Type the SCPI commands at the prompt.

## Using Sockets

### NOTE

Power supplies allow any combination of up to six simultaneous data socket, control socket, and telnet connections to be made.

Keysight instruments have standardized on using port 5025 for SCPI socket services. A data socket on this port can be used to send and receive ASCII/SCPI commands, queries, and query responses. All commands must be terminated with a newline for the message to be parsed. All query responses will also be terminated with a newline.

The socket programming interface also allows a control socket connection. The control socket can be used by a client to send device clear and to receive service requests. Unlike the data socket, which uses a fixed port number, the port number for a control socket varies and must be obtained by sending the following SCPI query to the data socket: **SYSTem:COMMunicate:TCPIp:CONTRol?**

After the port number is obtained, a control socket connection can be opened. As with the data socket, all commands to the control socket must be terminated with a newline, and all query responses returned on the control socket will be terminated with a newline.

To send a device clear, send the string "DCL" to the control socket. When the power system has finished performing the device clear it echoes the string "DCL" back to the control socket.

Service requests are enabled for control sockets using the Service Request Enable register. Once service requests have been enabled, the client program listens on the control connection. When SRQ goes true the instrument will send the string "SRQ +nn" to the client. The "nn" is the status byte value, which the client can use to determine the source of the service request.

## Interface Lockout

The USB interface, LAN interface, and the Web server are enabled when shipped. To enable or disable the interfaces from the front panel:

Front Panel Menu Reference	SCPI Command
Select <b>System\Admin\IO</b>	Not available
Enable or disable the interfaces by checking or unchecking: Enable LAN, Enable GPIB, and Enable USB	
Press Select.	

If you cannot access the Admin menu, it may be password protected.

# 4

## Using the Advanced Power System

**Programming the Output**

**Programming Output Protection**

**Programming Output Transients (Step, List, Arb)**

**Sequencing the Output**

**Making Measurements**

**Using Expression Signal Routing**

**Programming the Digital Port**

**External Data Logging (Elog)**

**Black Box Data Recording**

**Current Sharing Operation**

**Current Sinking Operation**

**System-Related Operations**

**Priority Mode Tutorial**

**Current Sharing Tutorial**

## Programming the Output

**Set the Output Priority Mode**

**Set the Output Voltage**

**Set the Output Current**

**Set the Slew Rate**

**Enable the Output**

**Set the Output Bandwidth**

**Set the Output Resistance**

**Configure the Output Relays**

**NOTE**

When the APS is first turned on, it may take about 30 seconds or so to initialize the instrument before it is ready for use.

### Set the Output Priority Mode

You can select either Voltage priority or Current priority mode.

Voltage priority mode is used when you want the output voltage to remain constant. The output voltage will remain at its programmed setting as long as the load current remains within the positive or negative current limit setting.

Current priority mode is used when you want the output current to remain constant. The output current will remain at its programmed setting as long as the load voltage remains within the voltage limit setting.

Refer to [Priority Mode Operation](#) for more information.

Front Panel Menu Reference	SCPI Command
Select <b>Output\Mode</b> .	To specify current or voltage priority mode:
Select either Voltage priority or Current priority.	<b>FUNC CURR VOLT</b>
Then press <b>Select</b> .	

**NOTE**

When switching between Voltage priority and Current priority mode, the output is turned off and the output settings revert to their Power-on or RST values.

### Set the Output Voltage

When the unit is in voltage priority mode, the output voltage remains at its programmed setting as long as the load current remains within its programmed positive or negative limit.

Front Panel Menu Reference	SCPI Command
Press the <b>Voltage</b> key. Enter a value and press <b>Select</b> .	To set the output voltage to 40 volts: <b>VOLT 40</b>

When the unit is in current priority mode, you can specify a voltage limit which limits the output voltage at the specified value. The output current will remain at its programmed setting as long as the load voltage remains within the voltage limit setting.

Front Panel Menu Reference	SCPI Command
Press the <b>Voltage</b> key. Enter a + Voltage limit and press <b>Select</b> .	To set the voltage limit: <b>VOLT:LIM 42</b>

## Set the Output Current

When the unit is in voltage priority mode, you can specify a positive and negative current limit, which limits the output current at the specified value. In voltage priority mode, the output voltage remains at its programmed setting as long as the load current remains within its programmed positive or negative limit.

Front Panel Menu Reference	SCPI Command
Press the <b>Current</b> key. Specify a positive or negative Current limit. Then press <b>Select</b> .	To set the positive current limit: <b>CURR:LIM 12</b>  To set the negative current limit: <b>CURR:LIM:NEG -3</b>

When the unit is in current priority mode, you can specify a positive or negative output current level, which will be maintained as long as the output voltage remains within its programmed limit.

Front Panel Menu Reference	SCPI Command
Press the <b>Current</b> key. Enter a positive or negative value. Then press <b>Select</b> .	To set the output current to +5 amperes: <b>CURR 5</b>  To set the output current to -5 amperes: <b>CURR -5</b>

## Set the Slew Rate

The voltage slew rate determines the rate at which the voltage changes to a new programmed setting. This applies to both voltage settings in voltage priority mode, and voltage limit settings in current priority mode. When set to MAXimum, INFinity, or to a very large value, the slew rate will be limited by the analog performance of the output circuit. This setting can be used to prevent crossover into current limit while up- and down-programming capacitive loads. Use the following equation to calculate the maximum slew rate limit to ensure smooth and linear up- and down-programming performance.

$$\text{Max slew rate ( V/s)} = (\text{Current limit setting (A)} - \text{Load current (A)}) / (\text{Load capacitance (F)})$$

## 4 Using the Advanced Power System

The current slew rate determines the rate at which the current changes to a new programmed setting. This applies to both current settings in current priority mode, and current limit settings in voltage priority mode. When set to MAXimum, INFinity, or to a very large value, the slew rate will be limited by the analog performance of the output circuit.

Front Panel Menu Reference	SCPI Command
Select <b>Output\Advanced\Slew</b>	To set the voltage slew rate to 5 V/s <b>VOLT:SLEW 5</b>
Then select Voltage or Current	
Enter the voltage or current slew rate in the Slew Rate field.	To set the current slew rate to 1 A/s <b>CURR:SLEW 1</b>
Check Max slew rate to program the fastest slew rate.	To set the fastest slew rate: <b>VOLT:SLEW MAX</b>

### Set the Output Bandwidth

Voltage bandwidth modes allow you to optimize output response time with capacitive loads.

**1** (High) bandwidth mode provides maximum up-programming speed as well as the fastest transient response settling time. This mode is optimized for use with resistive loads; however capacitive loads up to the limits outlined in the following table can be used when using load leads shorter than 3 meters (10 feet). Exceeding these limits can lead to voltage programming overshoots and transient response instability.

**0** (Low) bandwidth mode is optimized for use with large capacitive loads up to the limits shown in the table below, along with load leads longer than 3 meters (10 feet). In this mode the up- and down-programming speed and voltage control-loop bandwidth are limited to prevent voltage programming overshoots and improve transient response stability. Low mode provides the best stability and overshoot minimization over all load configurations.

#### NOTE

Connecting very low ESR capacitors larger than the High mode limit with load leads shorter than 3 m (10 ft.) is not recommended in either bandwidth range. This load configuration can lead to voltage programming overshoots.

<frequency> **N7900 models** **N6900 Opt 303** specifies the low-pass corner frequency of a filter applied to the programming signal. The programmed voltage is a digitized signal which passes through a single-pole low pass filter where the pole is specified in Hertz. This filter has the effect of slowing down the output with respect to changes in the programmed voltage or current. This, in combination with the configurable slew setting, allows for a trade-off between programming speed and output voltage or current overshoot. For example, increasing the filter frequency may result in more overshoot and decreasing the frequency will lower the overshoot, depending on the compensation setting and the load impedance. This frequency setting does not affect the unit's transient response to a load change.

#### NOTE

Low-pass corner frequency programming is only available on units with firmware revisions A.02.01.1256 and B.02.01.1256 and up. See [Firmware Update](#).

1 kW Models	High limit	Low limit	2 kW Models	High limit	Low limit
N6950A/N7950A	0 to 3800 $\mu$ F	0 to 190,000 $\mu$ F	N6970A/N7970A	0 to 7600 $\mu$ F	0 to 380,000 $\mu$ F
N6951A/N7951A	0 to 1000 $\mu$ F	0 to 50,000 $\mu$ F	N6971A/N7971A	0 to 2000 $\mu$ F	0 to 100,000 $\mu$ F
N6952A/N7952A	0 to 240 $\mu$ F	0 to 12,000 $\mu$ F	N6972A/N7972A	0 to 480 $\mu$ F	0 to 24,000 $\mu$ F
N6953A/N7953A	0 to 100 $\mu$ F	0 to 5600 $\mu$ F	N6973A/N7973A	0 to 200 $\mu$ F	0 to 11,200 $\mu$ F
N6954A/N7954A	0 to 60 $\mu$ F	0 to 3000 $\mu$ F	N6974A/N7974A	0 to 120 $\mu$ F	0 to 6000 $\mu$ F
			N6976A/N7976A	0 to 50 $\mu$ F	0 to 2,800 $\mu$ F
			N6977A/N7977A	0 to 30 $\mu$ F	0 to 1,500 $\mu$ F

Front Panel Menu Reference	SCPI Command
Select <b>Output\Advanced\Bandwidth</b> . Select either 1 (High or 0 (Low). Enter the pole frequency. <b>N7900 models</b> <b>N6900 Opt 303</b>	To select the compensation bandwidth: <b>VOLT:BWID:RANG 0 1</b>  To specify the pole frequency: <b>VOLT:BWID_:LEV 0, &lt;frequency&gt;</b>
Then press <b>Select</b> .	

## Set the Output Resistance

Output resistance programming is mainly used in battery testing applications and only applies in Voltage Priority mode. It is used to emulate the internal resistance of a non-ideal voltage source such as a battery. Values are programmed in ohms. Model-specific resistance programming ranges are as follows:

1 kW Models	Range	2 kW Models	Range	2 kW High Voltage	Range
N6950A/N7950A	0 to 0.1 $\Omega$	N6970A/N7970A	0 to 0.05 $\Omega$	N6976A/N7976A	0 to 6.8 $\Omega$
N6951A/N7951A	0 to 0.4 $\Omega$	N6971A/N7971A	0 to 0.2 $\Omega$	N6977A/N7977A	0 to 12.8 $\Omega$
N6952A/N7952A	0 to 1.6 $\Omega$	N6972A/N7972A	0 to 0.8 $\Omega$		
N6953A/N7953A	0 to 3.4 $\Omega$	N6973A/N7973A	0 to 1.7 $\Omega$		
N6954A/N7954A	0 to 6.4 $\Omega$	N6974A/N7974A	0 to 3.2 $\Omega$		

Front Panel Menu Reference	SCPI Command
Select <b>Output\Advanced\Resistance</b> . Specify an Output Resistance value. Then check the <b>Enable</b> box. Then press <b>Select</b> .	To enable output resistance: <b>VOLT:RES: ON</b>  To select a resistance of 0.5 ohms: <b>VOLT:RES: 0.5</b>

## Enable the Output

Because of internal circuit start-up procedures and any installed relay options, OUTPut ON may take tens of milliseconds to complete its function. OUTPut OFF delays may also be in effect. For more information regarding output turn-on and turn-off delays, refer to [Turn-On Turn-Off Behavior](#).

Front Panel Menu Reference	SCPI Command
Press the <b>On/Off</b> key.	<b>OUTP ON OFF</b>

### NOTE

In addition to the front panel and SCPI Output On and Output Off commands, you can also use OnCouple, OffCouple, and expression signals to enable and disable the output. Refer to [Sequencing the Output](#) for more information.

## Configure the Output Relays

**N7900 models**

**N6900 Opt 760**

**N6900 Opt 761**

Double-pole, double-throw relays are provided to disconnect both the output and sense terminals. A polarity reversal function is also provided.

The normal operating mode of the relay is to open and close as the output is turned on or off. The relays are only opened or closed when the output is at a safe state (zero voltage; zero current). You can lock the relays so that they are always closed. This can circumvent any additional relay turn on/turn off delays present due to the output relays.

Front Panel Menu Reference	SCPI Command
Select <b>System\Preferences\Relay</b> .	To leave the relays closed:
Select <b>Lock Closed</b> to leave the relays closed at all times, and press <b>Select</b> .	<b>OUTP:REL:LOCK ON</b>

You can also reverse the polarity of the output and sense terminals. Note that this command briefly turns the output off while the output and sense terminal polarities are switched. Also note that you can enable or disable the function of the polarity reversal to prevent accidental use.

Polarity reversal is not available on models N6950A Opt 761, N6970A Opt 761, N7950A, and N7970A.

Front Panel Menu Reference	SCPI Command
Select <b>Output\Advanced\Pol</b> .	To switch the output and sense terminal polarities of the output:
Check the <b>Reverse</b> box. Then press <b>Select</b> . Uncheck the <b>Reverse</b> box to return the polarity to normal.	<b>OUTP:REL:POL REV</b>
To enable polarity reversal, select <b>System/Preferences/Relay</b> then check <b>Enable Polarity Reverse</b> . Then press <b>Select</b> . Uncheck the <b>Enable Polarity Reverse</b> box to lock out polarity reversal.	To return the polarities back to normal: <b>OUTP:REL:POL NORM</b>
	To lock out polarity reversal: <b>OUTP:REL:POL ENAB OFF</b>

**NOTE**

Although the plus and minus rails of the output power mesh are physically disconnected from the output terminals, an AC filter network is still connected to the plus and minus sense and output terminals as shown in the following figure. This AC network is required to meet EMI regulations.

AC Filter Network	Model	C1	C2	R1
	N7950A	10 $\mu$ F	0.3 $\mu$ F	0.15 $\Omega$
	N7951A	3.3 $\mu$ F	0.2 $\mu$ F	0.25 $\Omega$
	N7952A	2.2 $\mu$ F	0.1 $\mu$ F	0.3 $\Omega$
	N7953A	1 $\mu$ F	0.047 $\mu$ F	0.5 $\Omega$
	N7954A	0.47 $\mu$ F	0.047 $\mu$ F	0.5 $\Omega$
	N7970A	20 $\mu$ F	0.6 $\mu$ F	0.075 $\Omega$
	N7971A	6.6 $\mu$ F	0.4 $\mu$ F	0.125 $\Omega$
	N7972A	4.4 $\mu$ F	0.2 $\mu$ F	0.15 $\Omega$
	N7973A	2 $\mu$ F	0.94 $\mu$ F	0.25 $\Omega$
	N7974A	0.94 $\mu$ F	0.94 $\mu$ F	0.25 $\Omega$
	N7976A	0.5 $\mu$ F	0.0235 $\mu$ F	1 $\Omega$
	N7977A	0.235 $\mu$ F	0.0235 $\mu$ F	1 $\Omega$

## Programming Output Protection

**Set the Over-Voltage Protection**

**Set the Over-Current Protection**

**Output Watchdog Timer**

**User-Defined Protection**

**Clear Output Protection Functions**

**Protection Shutdown Behavior**

### Introduction

The APS models have many protection functions. These functions disable the output to protect the device under test as well as the power supply. A front panel status indicator will turn on when a protection function has been set. Most protection functions are latching, which means that they must be cleared once they have been set. Of the following protection functions, the OV, OC, PROT, INH, and UProt are user-programmable.

OV	Over-voltage protection is a hardware OVP whose trip level is a user-programmable value. Over-voltage protection also occurs automatically if the remote sense leads are shorted. OV protection is always enabled.
OV-	Negative over-voltage protection detects if the remote sense leads are reversed. At instrument turn-on, it also detects if voltages more negative than -2V are present at the output terminals. OV- protection is not programmable and is always enabled.
OC	Over-current protection is a user-programmable function that can be enabled or disabled. When enabled, the output will be disabled when the output reaches the current limit setting.
CP+	Positive over-power compares the output power against a built-in threshold. A CP+ protection occurs when the threshold is exceeded. CP+ protection is always enabled.
CP-	Negative over-power compares the internally dissipated power against a built-in threshold. A CP- protection occurs when the threshold is exceeded. CP- protection is always enabled.
OT	Over-temperature protection monitors the internal temperature of the power supply and disables the output if the temperature exceeds the pre-defined limit (see <b>OUTPut:PROTection:TEMPerature:MARGin?</b> ). Note that sensor information from any connected power dissipator is combined with the information from the power supply into a single indicator. OT protection is always enabled.
PF	Power-fail indicates that a power fail condition on the AC mains has occurred and has disabled the output. PF protection is always enabled.
EDP	Excessive dynamic protection disables the output in the event of excessive large repetitive voltage swings caused by programmed voltage changes, lists, Arbs, or load-induced voltage swings (see <b>Output Dynamic Response</b> ). If unchecked, these voltage swings could result in premature failure of components in the instrument. EDP protection is always enabled.
Prot	Prot indicates the output is disabled because the programmed output watchdog timer expired.
INH	The Inhibit input (pin 3) on the rear panel digital connector can be programmed to act as an external shutdown signal. Refer to <b>Inhibit Input</b> for further information.
UProt	A User-defined protection condition has disabled the output.

## Set the Over-Voltage Protection

The over-voltage protection will turn the output off if the output voltage reaches the programmed over-voltage limit. The OVP circuit monitors the voltage at the + and – sense terminals. Note that an OVP shutdown will automatically occur if the + and – sense leads are accidentally shorted to each other.

Front Panel Menu Reference	SCPI Command
Select <b>Protect\OVP</b> Enter a value in the OVP level box. Then press <b>Select</b> .	To set the OVP level to 50 volts: <b>VOLT:PROT 50</b>

## Set the Over-Current Protection

### Enable OCP

When over-current protection is enabled, the power supply turns off the output if the output current reaches the current limit setting and transitions from constant voltage (CV) to current limit (CL+ or CL-) mode.

Front Panel Menu Reference	SCPI Command
Select <b>Protect\OCP</b> Check <b>Enable OCP</b> . Then press <b>Select</b> .	To enable OCP: <b>CURR:PROT:STAT ON</b>

### Delay OCP

You can specify an OCP delay to prevent momentary output settings, load, and status changes from tripping the over-current protection. In most cases these momentary conditions would not be considered an over-current protection fault, and having an OCP condition disable the output when they occur would be a nuisance. Specifying an OCP delay lets the OCP circuit ignore these momentary changes during the specified delay period. Once the OCP delay time has expired and the over-current condition persists, the output will shut down.

The following selections are available to start the over-current delay timer:

**Settings Change** this starts the over-current delay whenever a command changes the output settings. It includes changes made by the transient system so that the timer is started at each list step and at each Arb output change. It also includes voltage and current slew changes, so that the timer is restarted throughout the entire slew time.

**Current Limit** starts the over-current delay timer by any transition of the output into current limit mode.

The delay can be programmed from 0 to 0.255 seconds. You can specify if the OCP delay timer is started by any transition of the output into CC mode, or only at the end of a settings change in voltage, current, or output state.

Front Panel Menu Reference	SCPI Command
Select <b>Protect\OCP</b>	To specify a 10 millisecond delay: <b>CURR:PROT:DEL 0.01</b>
Enter a delay value. Then press <b>Select</b> .	
By default, the delay timer will be started by an output settings change.	To start the delay timer by an output settings change: <b>CURR:PROT:DEL:STAR SCH</b>
Check "Start delay on CC" to start the delay timer by ANY output transition into CL mode.	To start the delay timer by ANY output transition into CL mode: <b>CURR:PROT:DEL:STAR CCTR</b>

Factors that influence how long the output settings or load change may last include: difference between old output value and new output value, the current limit setting, and the load capacitance in CV mode or load inductance in CC mode. The delay required must be determined empirically; the output programming-response time characteristics may be used as guidelines.

Also note that the time it takes the output to go into CL mode varies - depending on the magnitude of the over-current condition compared to the current limit setting. For example, if the over-current is only slightly greater than the current limit setting, it may take several tens of milliseconds for the output to set the CC status bit. If the over-current is significantly greater than the current limit setting, it may only take a few hundred microseconds or less for the output to set the CL status bit. To determine when the output will shut down, you must add the time it takes for the CL status bit to the over-current protection delay time. If the over-current persists beyond the sum of these two time intervals, the output will shut down.

### Output Watchdog Timer

When enabled, the output watchdog timer causes the output to go into protection mode if there is no SCPI I/O activity on the remote interfaces (USB, LAN, GPIB) within the user-specified time period. Note that the watchdog timer function is NOT reset by activity on the front panel - the output will still shut down after the time period has elapsed.

After the time period has expired, the output will be disabled, but the programmed output state is not changed. The Prot bit in the status questionable register as well as the Prot indicator on the front panel will be set. A watchdog protect can be cleared as described under Clear Output Protection Functions below.

The watchdog delay can be programmed from 1 to 3600 seconds in 1-second increments. To enable the watchdog timer and specify a delay value, proceed as follows:

Front Panel Menu Reference	SCPI Command
Select <b>Protect\WDog</b>	To enable the output watchdog timer: <b>OUTP:PROT:WDOG ON</b>
Check Enable Watchdog to enable the watchdog timer.	
Enter a value in the Watchdog Delay box. Then press <b>Select</b> .	To set the output watchdog timer to 120 seconds: <b>OUTP:PROT:WDOG:DEL 120</b>

## User-Defined Protection

User-defined protection lets you expand the built-in protection capabilities of the APS to include additional output behavior and status conditions. This is accomplished by programming a user-defined signal expression and routing it to the protection circuit of the unit. See [Using Expression Signal Routing](#). When the expression is true, it responds with a latching user-defined protect (UProt), and disables the output. To enable User-defined protection:

Front Panel Menu Reference	SCPI Command
Select <b>System\Signal\Protect</b>	Enable user-protection: <b>OUTP:PROT:USER:STAT ON</b>
Check Enable to enable user protection.	
Select the expression from the Source dropdown list. Then press <b>Select</b> .	Select an expression from 1 to 8: <b>OUTP:PROT:USER:SOUR EXPR&lt;1-8&gt;</b>

## Clear Output Protection Functions

If an over-voltage, over-current, over-temperature, power-fail condition, power-limit condition, protection condition, or inhibit signal occurs, the output is disabled. The appropriate operating status indicator on the front panel will be on. To clear the protection function and restore normal operation, first remove that condition that caused the protection fault. Then, clear the protection function as follows:

Front Panel Menu Reference	SCPI Command
Select <b>Protect\Clear</b>	To clear a protection fault: <b>OUTP:PROT:CLE</b>
Select Clear.	

## Protection Shutdown Behavior

The following table describes the default protection shutdown behavior of the APS models. When a protection event occurs the APS will attempt to disable the output in the following manner:

N6900 models without relay options	These models do not have output disconnect relays. When a protection event occurs, the unit immediately stops output power conversion and attempts to actively down-program the output voltage for 2 ms (at up to 120% of the current rating). Down-programming continues using the unit's passive internal network, which leaves the system in a safe and discharged state in most applications. The unit remains in the latched protection state until protection is cleared.
N7900 models and N6900 models with relay options (all except N7976A, N7977A, N6976A, and N6977A)	These models have galvanic output disconnect relays. In addition to the down-programming procedure used in the N6900 models, the N7900 model relays are signaled to open immediately after the protection event occurs. Note that the galvanic relays can take up to 20 ms to completely open.

N7976A, N7977A models and  
N6976A, N6977 models with relay  
options

Due to the higher voltage capability of these models, they are equipped with a fast solid-state disconnect switch (< 5  $\mu$ s turn-off time) in series with the galvanic relays. When a protection event occurs, the solid-state switch opens after the 2 ms down-programming period. Following this, the galvanic relays will open after their 20 ms delay has elapsed.

## Customizing the Shutdown Behavior

This feature is available on firmware revision A.01.13 and up.

If your device under test has energy sourcing capability as is the case for batteries, power supplies, or large capacitors, the down-programming capability of the protection function could cause undesirable effects on the device under test.

Therefore, you can customize the protection shutdown behavior according to the following selections:

**Low Impedance** - the output voltage is programmed to zero, then disconnected. Maximum negative current sinking occurs for 2 ms during the turn-off transition. This is the default protection behavior as described in the previous table.

**High Impedance** - the output is disconnected without actively sinking current. Without active current sinking, output energy will take longer to dissipate - as downprogramming is solely determined by the unit's passive internal network.

The following command lets you configure the turn-off behavior for all protection conditions:

Front Panel Menu Reference	SCPI Command
Select <b>Protect\Mode</b>	To select High impedance mode: <b>OUTP:PROT:MODE HIGHZ</b>
Check either High Impedance or Low Impedance. Then press <b>Select</b> .	To select Low impedance mode: <b>OUTP:PROT:MODE LOWZ</b>

**NOTE**

When switching modes from Voltage Priority to Current Priority and vice-versa, the mode setting reverts to Low Impedance mode for safety reasons.

If a power-fail shutdown fault occurs on models with output voltages greater than 60 V, the down-programmer circuit remains enabled for this fault condition for safety reasons.

## Programming Output Transients

### Common Actions for All Transients

#### Programming a Step Transient

#### Programming a List Transient

#### Programming an Arbitrary Waveform

## Output Transients

An output transient is defined as a triggered action that causes a change in output voltage or current. The three available transient types are: step, list, and arbitrary waveforms.

**Step** - a one-time event that steps the output voltage or current up or down in response to a trigger.

**List** - describes a precisely timed, complex sequence of output steps or changes.

**Arbitrary Waveform** - allows the output to generate complex user-defined voltage or current waveforms of up to 65,535 data points.

### Common Actions for All Transients

- Enable the output transient function
- Program the transient parameters
- Select the trigger source
- Initiate the transient system
- Trigger the transient

The transient trigger process is illustrated below. This applies to all transient types. The arrows on the right are specific to List transients. For an overview of the trigger system, refer to [Trigger Overview](#).

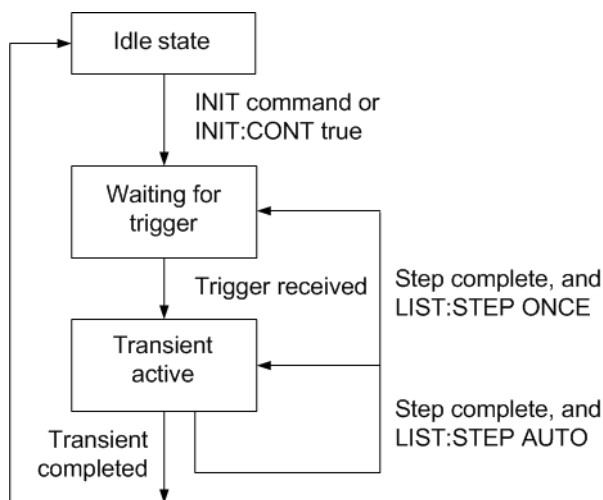

## Enable the output transient function

First, you must enable the output to respond to transient triggers. Unless an output transient function enabled, nothing will happen even if you have programmed the transient parameters and generated a transient trigger.

Front Panel Menu Reference	SCPI Command
Select <b>Transient\Mode</b> .	To enable the transient function, use:
If you are operating in voltage priority mode select Voltage mode. If you are operating in current priority mode select Current mode.	<b>VOLT:MODE STEP</b> <b>VOLT:MODE LIST</b> <b>VOLT:MODE ARB</b>
In the dropdown list, select Step, List or Arb transients. Then press <b>Select</b> .	or <b>CURR:MODE STEP</b> <b>CURR:MODE LIST</b> <b>CURR:MODE ARB</b>

### NOTE

In Step mode, the triggered value becomes the immediate value when the trigger is received. In Fixed mode, trigger signals are ignored; the immediate values remain in effect when a trigger is received.

## Program the transient parameters

For example, set the triggered voltage level if you are programming a voltage step:

Front Panel Menu Reference	SCPI Command
Select <b>Transient\Step</b> .	To set a voltage step level of 15 V use:
Select the Trig Voltage box to set the voltage. Enter a value and press Select.	<b>VOLT:TRIG 15</b>

## Select the trigger source

### NOTE

A TRIGger:TRANSient[:IMMEDIATE] command over the bus will always generate an immediate transient trigger, regardless of the selected trigger source.

Unless you are using the front panel menu or a TRIGger:TRANSient[:IMMEDIATE] command to trigger the transient, select a trigger source from the following:

Trigger Source	Description
Bus	Selects GPIB device trigger, *TRG, or <GET> (Group Execute Trigger).
EXPRession<1-8>	Selects one of eight user-defined expressions. See <a href="#">Defining Signal Expressions</a> .
External	Selects ANY pin that is configured as a Trigger Input on the digital control port.
Immediate	Triggers the transient as soon as it is INITiated.
Pin<1-7>	Selects a specific pin that is configured as a Trigger Input on the digital control port.

Use the following commands to select a trigger source:

Front Panel Menu Reference	SCPI Command
Select <b>Transient\TrigSource</b> .	To select Bus triggers:
To select immediate triggers, select Imm.	<b>TRIG:TRAN:SOUR BUS</b>
To select Bus triggers, select Bus.	To select digital pin 5 as the trigger:
To select digital pin 5 as the trigger, select Pin 5, or EXT.	<b>TRIG:TRAN:SOUR PIN5</b>
To select expression1 as the trigger, select Expr1.	To select expression1 as the trigger:
	<b>TRIG:TRAN:SOUR EXPR1</b>

## Initiate the transient system

When the unit is turned on, the trigger system is in the idle state. In this state, the trigger system is disabled, ignoring all triggers. The INITiate commands enable the trigger system to receive triggers.

Front Panel Menu Reference	SCPI Command
Select <b>Transient\Control</b> .	To initiate the transient trigger system:
Scroll to Initiate. Then press <b>Select</b> .	<b>INIT:TRAN</b>

It takes a few milliseconds for the instrument to be ready to receive a trigger signal after receiving the INITiate:TRANSient command. If a trigger occurs before the trigger system is ready for it, the trigger will be ignored. You can test the WTG\_tran bit in the operation status register to know when the instrument is ready to receive a trigger after being initiated.

Front Panel Menu Reference	SCPI Command
Select <b>Transient\Control</b> .	To query the WTG_tran bit (bit 4):
The Trig state field indicates "Initiated".	<b>STAT:OPER:COND?</b>

If a bit value of 16 is returned in the query, the WTG\_tran bit is true, and the instrument is ready to receive the trigger signal. Refer to [Status Overview](#)

### NOTE

Unless INITiate:CONTinuous:TRANSient is programmed, the instrument executes one transient each time a trigger signal is received. Thus, it will be necessary to initiate the trigger system each time another triggered transient is desired.

## Trigger the transient

The trigger system is waiting for a trigger signal in the initiated state. You can immediately trigger the transient as follows:

Front Panel Menu Reference	SCPI Command
Select <b>Transient\Control</b> .	To generate a transient trigger:
Select Trigger to generate an immediate trigger signal regardless of the trigger source setting.	<b>TRIG:TRAN</b>
	Alternatively, if the trigger source is BUS, you can also program a <b>*TRG</b> or an IEEE-488 <get> command.

## 4 Using the Advanced Power System

As previously discussed, a trigger can also be generated by a digital pin, or a user-defined expression. If any of these systems are configured as the trigger source, the instrument will wait indefinitely for the trigger signal. If the trigger does not occur, you must manually return the trigger system to the idle state. The following commands return the trigger system to the idle state:

Front Panel Menu Reference	SCPI Command
Select <b>Transient\Control</b> . Then select the Abort control.	<b>ABOR:TRAN</b>

When a trigger is received, the triggered functions are set to their programmed transient values. When the triggered actions are completed, the trigger system returns to the idle state. You can test the TRAN-active bit in the Operation Status register to know when the transient trigger system has returned to the idle state.

Front Panel Menu Reference	SCPI Command
Select <b>Transient\Control</b> . The Trig state field indicates "Idle".	To query the TRAN-active bit (bit 6): <b>STAT:OPER:COND?</b>

If a bit value of 64 is returned in the query, the TRAN-active bit is true, and the transient action is NOT complete. When the TRAN-active bit is false, the transient action is complete. Refer to [Status Tutorial](#) for more information.

## Programming a Step Transient

### Program the Step Levels

Use the following commands to program the triggered output step level. The output will go to this level when the trigger is received. In the front panel menu, you can only program the step level based on the priority mode that you are operating in - voltage or current priority.

Front Panel Menu Reference	SCPI Command
Select <b>Transient\Step</b> .  Select the Trig Voltage box to set the voltage. Select the Trig Current box to set the current. Enter a value and press Select.	To set a voltage step level of 15 V use: <b>VOLT:TRIG 15</b>  To set a current step level of 1 A use: <b>CURR:TRIG 1</b>

### Generate a Trigger Out Signal

The output step can generate a trigger signal that can be routed to a pin on the digital port that has been configured as a trigger output (TOUT). Use the following commands to generate a trigger signal when the step occurs:

Front Panel Menu Reference	SCPI Command
Select <b>Transient\Step</b> .  Check Enable Trigger Output. Then press <b>Select</b> .	To program the Step to generate a trigger signal: <b>STEP:TOUT ON</b>

## Programming a List Transient N7900 models

- Program the list values
- Program the dwell values
- Specify the list pacing
- Specify any trigger signals that the list should generate
- Specify how many times you want the list to repeat
- Specify how you want the list to end

Lists let you generate complex sequences of output changes with rapid, precise timing, which may be synchronized with internal or external signals. In contrast to an output step, which is a one-time output change, an output list is a sequence of output changes. Lists can contain up to 512 individually programmed steps, and can be programmed to repeat themselves. Only the parameters associated with one of the priority modes, either voltage or current priority, may be list controlled.

The voltage and current lists are paced by a separate dwell list that defines the duration or dwell of each step. Each of the up to 512 steps can have a unique dwell time associated with it, which specifies the time in seconds that the list will remain at that step before moving on to the next step.

Lists can also be trigger-paced, in which the list advances one step for each trigger received. This is useful if you need an output list to closely follow triggered events. With a trigger-paced list, triggers that are received during the dwell period are ignored. You can set the list dwell time to zero ensure that no triggers are lost.

Lists can also generate trigger signals at specified steps. This is accomplished by two additional lists: a beginning-of-step (BOST) and an end-of-step (EOST) list. These lists define which steps will generate a trigger signal and if the trigger occurs at the beginning or end of the step. These trigger signals can be used to synchronize other events with the list.

All lists (voltage, current, dwell, BOST, EOST) must be set to the same number of steps, otherwise an error occurs when the list is run. For convenience, a list may be programmed with only one step or value. In this case, a single-step list is treated as if it had the same number of steps as the other lists, with all values being equal to the one value.

### NOTE

List data is not saved as part of a saved instrument state.

## Program the list values

**Example 1** If you are programming a voltage pulse or pulse train, set the amplitude of the pulse. For example, to generate a pulse with an amplitude of 15 V, program the amplitude for the pulse (step 0), and the amplitude for the off time (step 1).

## 4 Using the Advanced Power System

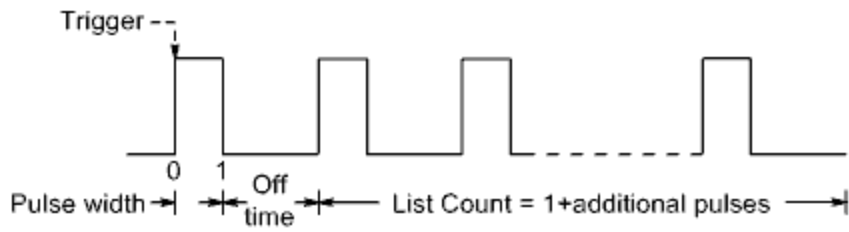

Front Panel Menu Reference	SCPI Command
Select <b>Transient\List\Config</b> .	To program the amplitude for step 0 (the pulse) and step 1 (the off time):
Select List Step 0 (the pulse) and enter a voltage value of 15. Press Select.	<b>LIST:VOLT 15,0</b>
Select List Step 1 (the off time) and enter a voltage value of 0. Press Select.	

**Example 2** If you are programming an arbitrary voltage list, specify the values for the list. The order in which the values are entered determines the order in which the values will be output. To generate the voltage list shown in the figure, a list may include the following values: 9, 0, 6, 0, 3, 0:

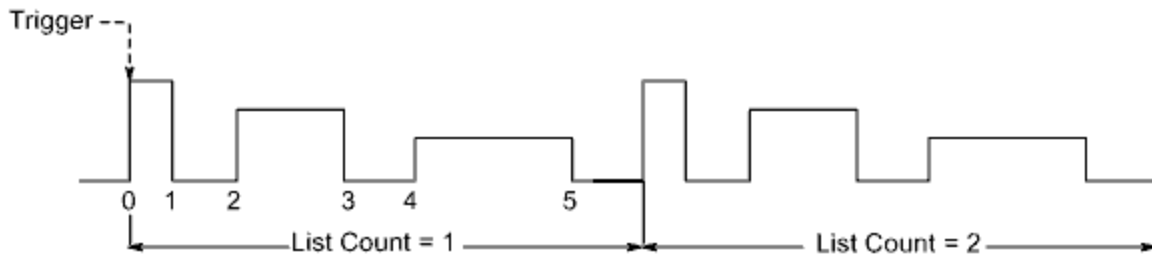

Front Panel Menu Reference	SCPI Command
Select <b>Transient\List\Config</b> .	To program a voltage list of 5 steps:
Select the List Step number and enter a voltage value. Press Select.	<b>LIST:VOLT 9,0,6,0,3,0</b>
Repeat this for each step. Use the up/down arrows to select the next step.	

### Program the dwell values

**Example 1** If you are programming a voltage pulse, set the dwell time of the pulse width. Also specify the dwell of the off time. This is necessary if you are generating a pulse train, since the off time determines the time between pulses. To generate a pulse with a pulse width of 1 second and an off time of 2 seconds, use:

Front Panel Menu Reference	SCPI Command
Select <b>Transient\List\Config</b> .	To program the dwell for step 0 (the pulse) and step 1 (the off time):
Select List Step 0 (the pulse) and enter a dwell value of 1. Press Select.	<b>LIST:DWEL 1,2</b>
Select List Step 1 (the off time) and enter a dwell value of 2. Press Select.	

You have now configured a single pulse. If you wish to generate a pulse train, simply specify the number of pulse repetitions as described under "Specify how many times you want the list to repeat".

**Example 2** If you are programming an arbitrary voltage list, specify the values for the list. The dwell values determine the time interval, in seconds, that the output remains at each step in the list before it advances to the next step. To specify the six dwell intervals in the figure, a list may include the following values: 2, 3, 5, 3, 7, 3:

Front Panel Menu Reference	SCPI Command
Select <b>Transient\List\Config</b> .	To program a dwell of 5 values, use:
Select the List Step number and enter a dwell value. Press Select.	<b>LIST:DWEL 2,3,5,3,7,3</b>
Repeat this for each step. Use the up/down arrows to select the next step.	

**NOTE**

The number of dwell steps must equal the number of voltage steps. If a dwell list has only one value, that value will be applied to all steps in the list.

## Specify the list pacing

You can specify if the list will be dwell or trigger-paced. The default selection is dwell-paced.

In a dwell paced list, each step is assigned a dwell time. The dwell time determines the time that the output remains at the step. As each dwell time elapses, the next step is immediately output.

In a trigger-paced list, the list advances one step for each trigger received. You can also a dwell period if you want to ignore triggers during the dwell time, or guarantee a minimum dwell time between triggered list steps.

Front Panel Menu Reference	SCPI Command
Select <b>Transient\List\Pace</b> .	To set the list pacing to dwell-paced:
Select either Dwell paced or Trigger paced. Then press <b>Select</b> .	<b>LIST:STEP AUTO</b>
	To set the list pacing to trigger-paced:
	<b>LIST:STEP ONCE</b>

### Specify any trigger signals that the list should generate

You can generate trigger signals that can be routed to other destinations. See [Using Expression Signal Routing](#). For example you can use trigger signals to trigger actions on any external equipment connected to the digital port. The following figure gives an example of generating four trigger signals on the arbitrary list of Example 2.



Front Panel Menu Reference	SCPI Command
Select <b>Transient\List\Config</b> .	To program a trigger at the beginning of step 4: <b>LIST:TOUT:BOST 0,0,0,0,1,0</b>
Select the List Step number 4. To generate a trigger, enter a 1 in the Tout Begin Step field.	To program a trigger at the end of step 0, 2, and 4: <b>LIST:TOUT:EOST 1,0,1,0,1,0</b>
Select the List Step numbers 0, 2, and 4. To generate a trigger, enter a 1 in the Tout End Step field.	
If zeroes are entered in the fields, no trigger is generated for the step.	

### Specify how many times you want the list to repeat

You can specify how many times you want the list (or pulse) to repeat. At reset, the list count is set to 1 repetition. Sending the INfinity parameter in the SCPI command makes the list repeat indefinitely.

Front Panel Menu Reference	SCPI Command
Select <b>Transient\List\Repeat</b> .	To program the list to repeat twice: <b>LIST:COUN 2</b>
Enter the number of list repetitions (2) and press Select.	

### Specify how you want the list to end

Specify the output state after the list has completed. There are two choices: the output returns to the value that was in effect before the list started, or the output remains at the value of the last list step.

Front Panel Menu Reference	SCPI Command
Select <b>Transient\List\Terminate</b> .	To return the output to the pre-list state: <b>LIST:TERM:LAST OFF</b>
Select either Return to Start, or Stop at Last Step and press Select.	To keep the output at the end list state: <b>LIST:TERM:LAST ON</b>

## Programming an Arbitrary Waveform N7900 models N6900 Opt 303

- Specify the Arb type and dwell
- Configure the Arb
- Specify how many times you want the Arb to repeat
- Specify how you want the Arb to end

### NOTE

Certain output amplitude and frequency combinations can exceed the instrument's dynamic response capability and cause the output to shut down, especially under no-load conditions. Refer to [Output Dynamic Response](#) for more information.

The output of the Keysight N7900 models can be modulated by the instrument's built-in arbitrary waveform generator. This allows the output to generate complex user-defined voltage or current waveforms. The following are key features of the constant-dwell arbitrary waveform generator:

- Generate voltage or current arbitrary waveforms.
- Arb's can contain up to 65,535 data points.
- A single dwell value applies to every point in the arbitrary waveform (constant-dwell).
- Only the Arb that corresponds to the active priority mode, either voltage or current priority, may be generated.

### Specify the Arb type and dwell

To specify the Arb type and dwell:

Front Panel Menu Reference	SCPI Command
Select <b>Transient\Arb\Config</b> .	To specify a voltage or current Arb:
In the dropdown list, pick either a voltage or a current Arb. Then press <b>Select</b> .	<b>ARB:FUNC:TYPE VOLT</b> <b>ARB:FUNC:TYPE CURR</b>
Enter a dwell value in the Dwell field. Then press <b>Select</b> .	To specify a dwell time of 1 millisecond: <b>ARB:VOLT:CDW:DWEL 0.001</b> <b>ARB:CURR:CDW:DWEL 0.001</b>

### Configure the Arb

Note that you can only *view* Arb point data from the front panel. You cannot *program* Arb data from the front panel. You must use the SCPI `ARB:CURRent:CDWell` or `ARB:VOLTage:CDWell` commands to program the Arb data.

## 4 Using the Advanced Power System

Front Panel Menu Reference	SCPI Command
Select <b>Transient\Arb\Config</b> .	To program 10 points in a current Arb: <b>ARB:CURR:CDW 1,2,2,3,4,4,3,2,2,1</b>
If Arb points have been imported or programmed using the SCPI command, the Points field displays the number of points in the Arb.	To query the number of Arb points: <b>ARB:CURR:CDW:POIN?</b>
View the amplitude of any Arb point by entering the point number in the Point # field. The Level field displays the amplitude.	To query the Arb point values: <b>ARB:CURR:CDW?</b>

### Specify how many times you want the Arb to repeat

Depending on your application, specify how many times you want the Arb to repeat. Sending the INfinity parameter in the SCPI command makes the Arb repeat indefinitely. At reset, the Arb count is set to 1.

Front Panel Menu Reference	SCPI Command
Select <b>Transient\Arb\Repeat</b> . Enter the number of list repetitions (2) and press Select.	To program the Arb to repeat twice: <b>ARB:COUN 2</b>

### Specify how you want the Arb to end

Specify the output state after the Arb has completed. There are two choices: the output returns to the state it was in before the Arb started, or the output remains at the values of the last Arb point.

Front Panel Menu Reference	SCPI Command
Select <b>Transient\Arb\Terminate</b> . Select either Return to Start, or Stop at Last Step and press Select.	To return the output to the pre-Arb state: <b>ARB:TERM:LAST OFF</b> To keep the output at the Arb end point: <b>ARB:TERM:LAST ON</b>

## Sequencing the Output

This section describes how you can synchronize output turn-on and turn-off sequences on single and multiple units.

### Turn-On/Turn-Off Behavior

#### Turn-On/Turn-Off Delays

#### Enabling/Disabling the Output

#### Sequencing Multiple Units

### Turn-On Turn-Off Behavior

The following figure illustrates the output turn-on and output turn-off sequence followed by a description of the individual components.

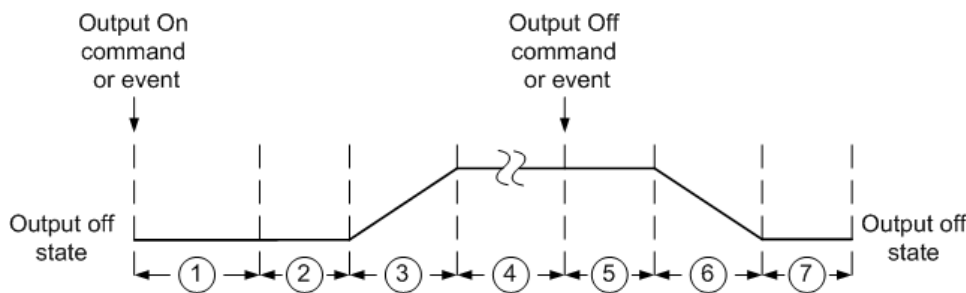

#### Sequence Description

1. Upon the receipt of an Output On command, the power supply waits for the duration of the user-programmed turn-on delay (which is zero by default).
2. In Voltage Priority mode the power supply programs the output to the minimum voltage setting during the internal delay time, which is 12 milliseconds for models without relay options and 38 milliseconds for models with relay options due to output relay closure. In Current Priority mode the power supply ensures that there is zero output current flow during the internal delay time, which is 14 milliseconds without relay closure and 46 milliseconds with relay closure.
3. The output is programmed to the output setting while following the slew rate and compliance limit.
4. The output reaches the programmed setting.
5. Upon the receipt of an Output Off command, the power supply waits for the duration of the user-programmed turn-off delay (which is zero by default).
6. In Voltage Priority mode the power supply down-programs the output to the minimum voltage setting. In Current Priority mode the power supply down-programs the output current to zero. In both cases the slew rate setting (if programmed) is followed. If a slow slew rate has not been programmed, the power supply may wait up to 250 milliseconds (but only as long as necessary) for the output to down-program before proceeding to the next step.

## 4 Using the Advanced Power System

- For models without relays, the output is turned off immediately. For models with relays, there is an additional 18 millisecond wait for the output relays to open before the output is turned off.

### NOTE

To circumvent the additional relay turn on/off delays, a non-volatile **OUTPut:RElay:LOCK** command can be sent, after which the delays will mirror those seen in models without output relays.

## Turn-On/Turn-Off Delays

All power supplies exhibit a maximum delay offset that applies from the time that a command to turn on the output is received until the output actually turns on. Specifying a common delay offset will serve as a reference point for any user-programmed turn-on delays. This user-defined offset also makes it possible to connect multiple power supplies together and program accurate turn-on sequences across multiple outputs. The user-programmed turn-on delay will then be added to the common user-defined reference point.

There is no need to specify a common delay offset when outputs turn off. Outputs start executing their turn-off delays as soon as an Output Off command is received. The maximum delay offset is shown in the following table.

Models	Voltage Priority	Current Priority
Models without relays or with locked relays	12 milliseconds	14 milliseconds
Models with output relays	38 milliseconds	46 milliseconds

## Enabling/Disabling the Output

In addition to the front panel and SCPI Output On and Output Off commands, you can also use OnCouple, OffCouple, and expression signals to enable and disable the output. These signals provide an additional level of control when sequencing the output on individual and multiple units.

The following figure illustrates the programming path when using the OnCouple, OffCouple, and expression signals to control the output.

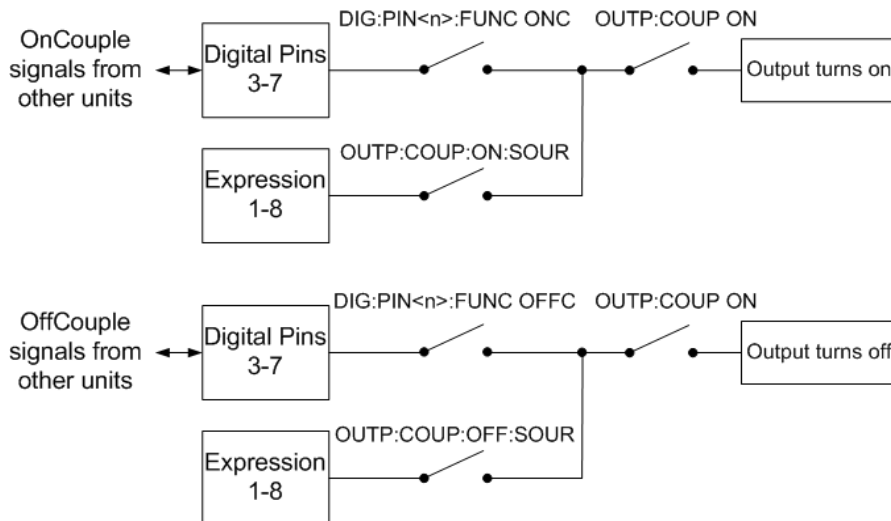

As shown in the figure, you can configure digital ports pins 3 through 7 to provide the OnCouple and OffCouple signals that enable or disable the output. The output is enabled or disabled when the corresponding signal is true. Refer to **Output Couple Control** for more information on configuring the digital port pins.

User-defined expression signals can also be used to enable or disable the output. User-defined expressions can combine a wide variety of status signals and output level conditions to create an expression signal that, when true, will enable or disable the output. Refer to **Defining Signal Expressions** and **Signal Expression Targets** for more information.

Lastly, you must enable output sequencing to use OnCouple, OffCouple, and expression signals to enable or disable the output. Refer to Enable Output Sequencing below.

## Sequencing Multiple Units

To sequence the output turn-on sequence for multiple units:

1. Connect and configure the digital connector pins of all units.
2. Enable the sequence function on each unit.
3. Specify the user-programmed turn-on delay for each unit.
4. This step is required if you have power supplies with **different** minimum delay offsets (see above). Specify a common delay offset for all of the sequenced units. The common delay offset must be larger or equal to the largest maximum delay offset. When the common delay offset completes, the user-programmed turn-on delays will start.

## Connect and Configure the Digital Connector Pins

The digital connector pins of the sequenced units must be connected together and configured. Refer to **Output Couple Control** for more information.

## Enable Output Sequencing

Output turn-on sequencing must be enabled on each unit that will participate in output turn-on synchronization.

Front Panel Menu Reference	SCPI Command
Select <b>Output\Sequence\Couple</b> .	To enable, send: <b>OUTP:COUP ON</b>
Check Enable to enable sequencing.	To disable, send: <b>OUTP:COUP OFF</b>
Uncheck to disable.	

### Specify the Turn-On and Turn-Off Delays for each Unit

Turn-on delays can be specified for all coupled units. Any delay sequence can be implemented. There are no restrictions on what the sequence is or what unit comes up first.

Front Panel Menu Reference	SCPI Command
Select <b>Output\Sequence\Couple</b> .	Program a turn-on delay:
Specify the Turn-on delay in seconds.	<b>OUTP:DEL:RISE .02</b>
Repeat for each additional unit.	Repeat for each instrument.

Turn-off delays can also be specified for all coupled units. Any delay sequence can be implemented. There are no restrictions on what the sequence is or what unit comes up first.

Front Panel Menu Reference	SCPI Command
Select <b>Output\Sequence\Couple</b> .	Program a turn-off delay:
Specify the Turn-off delay in seconds.	<b>OUTP:DEL:FALL .01</b>
Repeat for each additional unit.	Repeat for each instrument.

**NOTE** There is no need to specify a delay offset when outputs turn off. Outputs start executing their turn-off delays as soon as an Output Off command is received.

### Specify the Common Delay Offset

The following figures illustrate how the common delay offset can be used to synchronize the user-programmed turn-on delays when sequencing power supplies with different minimum delay offsets.

In the first figure, the actual start of the output turn on occurs at 22 ms, 58 ms, and 76 ms because the minimum delay offsets are added to the user-programmed turn on delay.

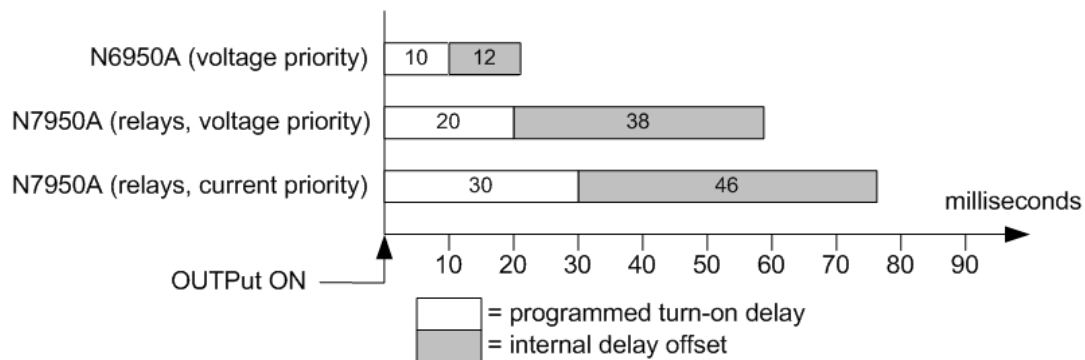

In the second figure, although you cannot eliminate the minimum delay offset, you can specify a common delay offset to accurately synchronize the user-programmed turn on delays with each other. In this example that actual start of the output turn-on occurs at 60 ms, 70 ms, and 80 ms respectively. You will always need to account for the common delay offset.

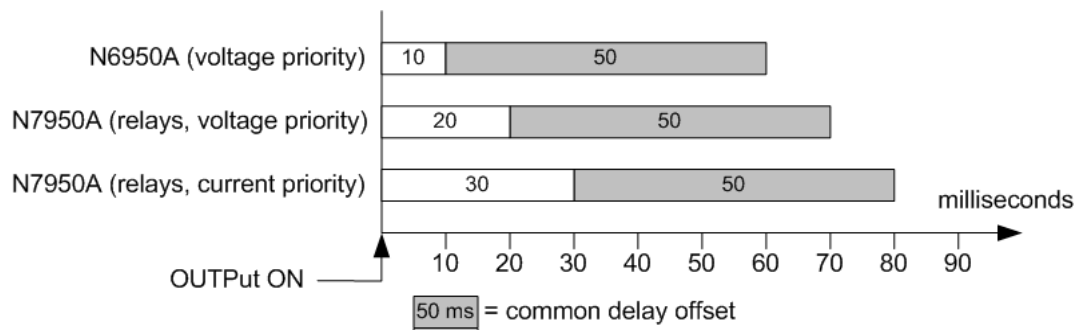

The common delay offset assures that the user-programmed turn-on delays will be synchronized to start at the completion of the common delay offset. Query the delay offset of each unit and use the slowest delay as the common delay offset.

Front Panel Menu Reference	SCPI Command
Select <b>Output\Sequence\Couple</b> .	To query the delay offset of the slowest unit:
The Max delay offset for this frame field displays the delay offset of the unit. Enter the delay offset value of the slowest unit in the Delay offset field in milliseconds. Then press <b>Select</b> .	<b>OUTP:COUP:MAX:DOFF?</b>
	Use the delay offset of the slowest unit to specify the common delay offset
	<b>OUTP:COUP:DOFF .051</b>

## Making Measurements

### Average Measurements

### Number of Power Line Cycles (NPLC)

### Measurement Windowing

### Seamless Current Measurement Ranging

### Amp-Hour and Watt-Hour Measurements

### Temperature Measurements

### Digitized Measurements

### Measurement Triggering

## Average Measurements

The APS models have a fully integrated voltmeter and ammeter to measure the actual voltage and current that is being supplied to the load.



Whenever the power supply is on, the front panel automatically measures output voltage and current by acquiring a number of measurements over the specified number of power line cycles, and averaging the samples. The default number of power line cycles is 1 cycle. At 1 cycle, the number of samples (or points) is 3255 @60 Hz and 3906 @50 Hz. The default sample interval is 5.12 microseconds.

Use the following commands to make a measurement:

Front Panel Menu Reference	SCPI Command
Select the <b>Meter</b> key.	To measure average (DC) output voltage, current, or power:
Repeatedly press the key to cycle through the following measurement functions:	<b>MEAS:VOLT?</b>
Voltage, Current	<b>MEAS:CURR?</b>
Voltage, Power	<b>MEAS:POW?</b>
Voltage, Current, Power	To return measurement data from the previously acquired array:
If dashes are displayed, the front panel measurement is interrupted because a remote interface measurement is taking place.	<b>FETC:VOLT?</b>
	<b>FETC:CURR?</b>
	<b>FETC:POW?</b>

## Number of Power Line Cycles (NPLC)

You can set the measurement time in number of power line cycles (NPLC). Using an integer number of power line cycles can reduce measurement noise from line frequency sources.

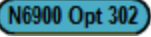
Front Panel Menu Reference	SCPI Command
Select <b>Measure</b> \NPLC 	To set the number of power line cycles to 10 use:
Select <b>Measure</b> \Sweep  	<b>SENS:SWE:NPLC 10</b>
Enter the number of power line cycles in the NPLC field. Then press <b>Select</b> .	

**NOTE**

The AC line frequency is detected automatically for the SENSE:SWEep:NPLC command.

## Measurement Windowing

Windowing is a signal conditioning process that reduces the error in average measurements made in the presence of periodic signals and noise. Two window functions are available: Rectangular and Hanning. At power-on, the measurement window is Rectangular.

The Rectangular window calculates average measurements without any signal conditioning. However, in the presence of periodic signals such as AC line ripple, a Rectangular window can introduce errors when calculating average measurements. This can occur when a non-integral number of cycles of data has been acquired due to the last partial cycle of acquired data.

One way of dealing with AC line ripple is to use a Hanning window. The Hanning window applies a  $\cos^4$  weighting function to the data when calculating average measurements. This attenuates the AC noise in the measurement window. The best attenuation is achieved when at least three or more waveform cycles are in the measurement.

Front Panel Menu Reference	SCPI Command
Select <b>Measure</b> \Window.	To set the sense window to Hanning use:
Select either Rectangular or Hanning. Then press <b>Select</b> .	<b>SENS:WIND HANN</b>

## Seamless Current Measurement Ranging

Keysight N7900 models have two current measurement ranges, a high and a low range (see [specifications](#)). A seamless current ranging function ensures that no data is lost due to range switching. Seamless ranging is enabled by default. The commands to enable seamless current measurement ranging are:

Front Panel Menu Reference	SCPI Command
Select <b>Measure</b> \Range.	To enable seamless measurement ranging:
Select Auto to enable seamless measurement ranging. Then press <b>Select</b> .	<b>SENS:CURR:RANG:AUTO ON</b>

You can also manually select the lower (or high) current measurement range. The lower current measurement range provides greater measurement accuracy, provided that the measurement does not exceed the range. If the measurement exceeds the range, an “Overload” error will occur. Use the following commands to select the low current measurement range.

Front Panel Menu Reference	SCPI Command
Select <b>Measure\Range</b> .	To set the 2.5 A range: <b>SENS:CURR:RANG 2.5</b>
Select the low (or high) measurement range from the current dropdown menu. Then press <b>Select</b> .	Program any value up to the highest rating of the range.

## Amp-Hour and Watt-Hour Measurements

Amp-hour and watt-hour measurements are available on all APS models. These measurements are made independently of other measurements.

The amp-hour and watt-hour measurements are created by accumulating full range current and power measurements at approximately 200k samples/second. The accumulators can hold enough data for at least 100,000 hours.

The approximate limit of accumulated charge is  $\pm(900,000,000 \cdot I_{RATING})$  in Coulombs or  $\pm(250,000 \cdot I_{RATING})$  in Amp-hours.

The approximate limit of accumulated energy is  $\pm(1,100,000,000 \cdot P_{RATING})$  in Joules or  $\pm(310,000 \cdot P_{RATING})$  in Watt-hours.

$I_{RATING}$  is the current rating of the unit.  $P_{RATING}$  is the power rating of the unit (either 1 kW or 2 kW).

Front Panel Menu Reference	SCPI Command
Select <b>Measure\Window\AHWH</b> .	To return the Amp-hours: <b>FETC:AHO?</b>
Displays the accumulated Amp-hours and Watt-hours.	To return the Watt-hours: <b>FETC:WHO?</b>
Select <b>Reset</b> to return the measurements to zero.	To reset Amp-hours and Watt-hours: <b>SENS:AHO:RES</b> <b>SENS:WHO:RES</b>

## Temperature Measurements

You can return the ambient temperature measured at the air inlet on the right side of the unit.

You can also return the difference in temperature between the internal temperature sensors and their over-temperature trip levels. The remaining temperature margin of the sensor that is closest to tripping the over-temperature protection is reported.

Temperature measurements are returned in degrees C.

Front Panel Menu Reference	SCPI Command
Select <b>Measure\Window\Temp</b> .	To return the ambient temperature: <b>SYST:TEMP:AMB?</b>
Displays the ambient temperature and over-temperature margin in degrees C.	To return the over-temperature margin: <b>OUTP:PROT:TEMP:MARG?</b>

## Digitized Measurements

N7900 models

N6900 Opt 302

In addition to the average voltage, current, and power measurements, which are available from both the front panel and via SCPI commands, digitized measurements can also be returned. Digitized measurements differ from average measurements because you can select the type of measurement returned and fine tune the measurement quality.

### Measurement Types

The following digitized measurements are available. These can only be measured using the corresponding SCPI command.

**ACDC** is a calculation that returns the total RMS measurement (AC + DC).

**HIGH** level is a calculation that generates a histogram of the waveform using 16 bins between the maximum and minimum data points. The bin containing the most data points above the 50% point is the high bin. The average of all the data points in the high bin is returned as the High level. If no high bin contains more than 1.25% of the total number of acquired points, then the maximum data point is returned.

**LOW** level is a calculation that generates a histogram of the waveform using 16 bins between the maximum and minimum data points. The bin containing the most data points below the 50% point is the low bin. The average of all the data points in the low bin is returned as the Low level. If no low bin contains more than 1.25% of the total number of acquired points, then the minimum data point is returned.

**MAX** is the maximum value of the digitized measurement.

**MIN** is the minimum value of the digitized measurement.

Array queries are also available to return ALL values in the voltage and current measurement buffer. No averaging is applied, only raw data is returned from the buffer.

Front Panel Menu Reference	SCPI Command
Not available	To measure RMS voltage & current: <b>MEAS:VOLT:ACDC?</b> <b>MEAS:CURR:ACDC?</b>
	To measure the high level of a pulse: <b>MEAS:VOLT:HIGH?</b> <b>MEAS:CURR:HIGH?</b>
	To measure the low level of a pulse: <b>MEAS:VOLT:LOW?</b> <b>MEAS:CURR:LOW?</b>
	To measure the maximum value: <b>MEAS:VOLT:MAX?</b> <b>MEAS:CURR:MAX?</b>

To measure the minimum value:

**MEAS:VOLT:MIN?**

**MEAS:CURR:MIN?**

To take a measurement and return array data:

**MEAS:ARR:VOLT?**

**MEAS:ARR:CURR?**

**MEAS:ARR:POW?**

### Measurement Quality

The following figure illustrates the relationship between measurement samples (or points), and the time interval between samples in a typical measurement. You can fine tune the measurement by specifying the number of points in the measurement acquisition as well as the time interval between points.

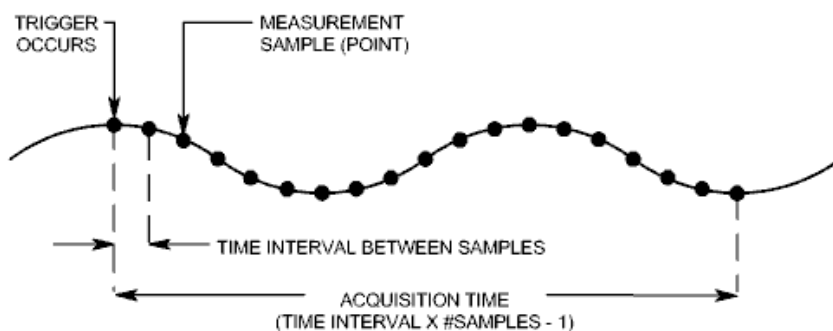

You can configure the measurement acquisition as follows:

Front Panel Menu Reference	SCPI Command
Select <b>Measure\Sweep</b> .	To set the time interval to 60 $\mu$ s with 4096 samples, use:
Enter the number of points. Then press <b>Select</b> .	<b>SENS:SWE:TINT 60E-6</b>
Enter the time interval. Then press <b>Select</b> .	<b>SENS:SWE:POIN 4096</b>

The maximum number of sample points that are available for all measurements is 512 K points (K = 1024).

Time interval values can range from 5.12 microseconds to 40,000 seconds for both voltage and current measurements. Values above 5.12 microseconds are rounded to the nearest 5.12 microsecond increment. Values above 10.24 microseconds are rounded to the nearest 10.24 microsecond increment. Values above 20.48 microseconds are rounded to the nearest 20.48 microsecond increment.

Note that Keysight N7900 models also support the **NPLC** (number of power line cycles) command to configure measurement tint and points as previously discussed. The NPLC command automatically increases the number of points to maintain the shortest possible time interval. If the maximum number of points for that time interval is reached, it increases the time interval.

## Measurement Triggering N7900 models N6900 Opt 302

- Capture pre-trigger data, if desired
- Select the trigger source
- Initiate the acquisition system
- Trigger the measurement
- Fetch the measurement
- Multiple trigger events per measurement

Use the acquisition trigger system to synchronize measurements with a trigger signal from the selected trigger source. Use FETCh commands to return measurement information from the acquired data.

The following figure illustrates the measurement acquisition process. This process applies to both measurement triggers and external data logging. For an overview of the trigger system, refer to [Trigger Overview](#).

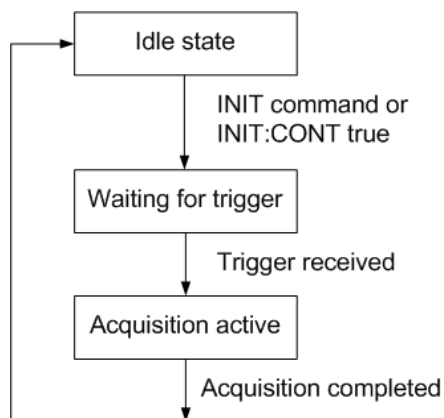

### Capture pre-trigger data, if desired

The measurement system lets you capture data before, after, or at the trigger signal. As shown in the following figure, you can move the block of data being read into the acquisition buffer with reference to the trigger. This allows pre- or post-trigger data sampling.

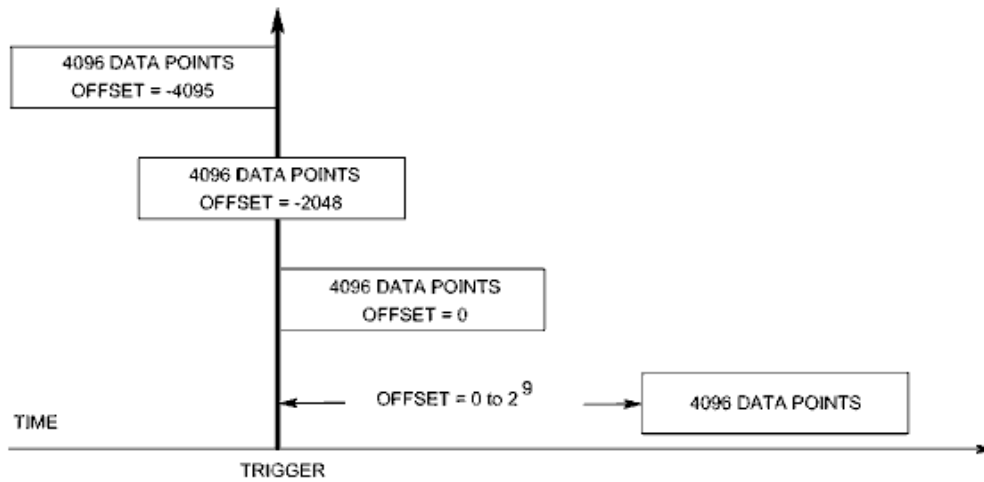

To offset the beginning of the acquisition buffer relative to the acquisition trigger:

Front Panel Menu Reference	SCPI Command
Select <b>Measure\Sweep</b> . Enter an Offset value. Then press <b>Select</b> .	To offset the measurement by 100 points use: <b>SENS:SWE:OFFS:POIN 100</b>

When the value is 0, all measurement samples are taken after the trigger. Positive values represent the delay after the trigger occurs but before the samples are acquired. This can be used to exclude measurement samples that occur during the delay time. (Delay time = offset x sample period). Negative values represent data samples taken prior to the trigger. This lets you acquire measurement samples prior to the trigger.

### Select the trigger source

**NOTE** A TRIGger:ACQuire[:IMMediate] command over the bus will always generate an immediate measurement trigger, regardless of the selected trigger source.

Unless you are using TRIGger:ACQuire[:IMMediate], select a trigger source from the following:

Trigger Source	Description
Bus	Selects GPIB device trigger, *TRG, or <GET> (Group Execute Trigger).
Current1	Selects an output current level.
Expression<1-8>	Selects one of eight user-defined expressions. See <a href="#">Using Expression Signal Routing</a> .
External	Selects ANY pin that is configured as a Trigger Input on the digital control port.
Pin<1-7>	Selects a specific pin that is configured as a Trigger Input on the digital control port.
Transient1	Selects the unit's transient system. You must also set up the transient system to generate a trigger out signal. See <a href="#">Programming Output Transients</a> .
Voltage1	Selects an output voltage level.

Use the following commands to select a trigger source:

Front Panel Menu Reference	SCPI Command
Not available	To select Bus triggers: <b>TRIG:TRAN:SOUR BUS</b>
	To select digital pin 5 as the trigger: <b>TRIG:ACQ:SOUR PIN5</b>
	To select a voltage or current level: <b>TRIG:ACQ:SOUR VOLT1</b> <b>TRIG:ACQ:SOUR CURR1</b>
	To select an output transient as trigger: <b>TRIG:ACQ:SOUR TRAN1</b>
	To select expression1 as the trigger: <b>TRIG:ACQ:SOUR EXPR1</b>

### Initiate the acquisition system

When the unit is turned on, the trigger system is in the idle state. In this state, the trigger system is disabled, ignoring all triggers. The INITiate commands enable the trigger system to receive triggers.

Front Panel Menu Reference	SCPI Command
Not available	To initiate the measurement trigger system: <b>INIT:ACQ</b>

It takes a few milliseconds for the instrument to be ready to receive a trigger signal after receiving the INITiate:ACQuire command. If a trigger occurs before the trigger system is ready for it, the trigger will be ignored. You can test the WTG\_meas bit in the operation status register to know when the instrument is ready to receive a trigger after being initiated.

Front Panel Menu Reference	SCPI Command
Select <b>Measure\Control</b> . The Trig state field indicates "Initiated".	To query the WTG_meas bit (bit 3): <b>STAT:OPER:COND?</b>

If bit 3 is set in the query response, the WTG\_meas bit is true, and the instrument is ready to receive the trigger signal. Refer to [Status Tutorial](#) for more information.

#### NOTE

The instrument executes one measurement acquisition each time a bus, external, pin, transient, or expression trigger command is received. Thus, it will be necessary to initiate the trigger system each time a triggered measurement is desired.

### Trigger the Measurement

The trigger system is waiting for a trigger signal in the initiated state. You can immediately trigger the measurement as follows:

Front Panel Menu Reference	SCPI Command
Not available	To generate a measurement trigger: <b>TRIG:ACQ</b>  Alternatively, if the trigger source is BUS, you can also program a <b>*TRG</b> or an IEEE-488 <get> command.

As previously discussed, a trigger can also be generated by an output transient, a digital pin, and output voltage or current level, or a user-defined expression. If any of these systems are configured as the trigger source, the instrument will wait indefinitely for the trigger signal. If the trigger does not occur, you must manually return the trigger system to the idle state. The following commands return the trigger system to the idle state:

Front Panel Menu Reference	SCPI Command
Select <b>Measure\Control</b> .  Then select the Abort control.	<b>ABOR:ACQ</b>

## Fetch the measurement

After a trigger is received and the measurement completes, the trigger system returns to the idle state.

Once the measurement completes, FETCh queries can retrieve the most recent measurement data without initiating a new measurement or altering the data in the measurement buffer.

Front Panel Menu Reference	SCPI Command
Not available	To return RMS voltage & current: <b>FETC:VOLT:ACDC?</b> <b>FETC:CURR:ACDC?</b>  To return the high level of a pulse: <b>FETC:VOLT:HIG?</b> <b>FETC:CURR:HIG?</b>  To return the low level of a pulse: <b>FETC:VOLT:LOW?</b> <b>FETC:CURR:LOW?</b>  To return the maximum value: <b>FETC:VOLT:MAX?</b> <b>FETC:CURR:MAX?</b>  To return the minimum value: <b>FETC:VOLT:MIN?</b> <b>FETC:CURR:MIN?</b>  To return array data: <b>FETC:ARR:VOLT?</b> <b>FETC:ARR:CURR?</b> <b>FETC:ARR:POW?</b>

If a FETCh query is sent before the measurement is finished, the response will be delayed until the measurement trigger occurs and the acquisition completes. You can test the MEAS\_active bit in the operation status register to know when the measurement trigger system has returned to the idle state.

Front Panel Menu Reference	SCPI Command
Select <b>Measure\Control</b> . The Trig state field indicates "Idle".	To query the MEAS_active bit (bit 5): <b>STAT:OPER:COND?</b>

If bit 5 is set in the query response, the MEAS\_active bit is true, and the measurement is NOT complete. When the MEAS\_active bit is false, you can retrieve the measurement. Refer to **Status Tutorial** for more information.

### Multiple trigger events per measurement

The N7900 models can capture other triggers that occur during the acquisition, return the number and position of those triggers, and calculate DC values based on a subset of the data surrounding those triggers. The basic concept is that a single long acquisition may contain several events of interest, and that these events are marked by locations where additional triggers occurred. The locations of these events are described as an index into the acquisition's store of acquired data. Indices range from 0 to 1 less than the number of acquired readings (see **SENse:SWEep:POINts**).

You can query and return the indices where additional triggers occurred during the measurement. The number of indices returned matches the number of triggers that occurred.

Front Panel Menu Reference	SCPI Command
Not available	To query how many (if any) additional triggers occurred: <b>TRIG:ACQ:IND:COUN?</b>
	To return the indices where the triggers occurred: <b>TRIG:ACQ:IND?</b>

You can also return the actual measurement data that was captured after any of the aforementioned trigger indices.

Front Panel Menu Reference	SCPI Command
Not available	To return DC voltage or current calculated after the trigger indices: <b>FETC:VOLT? [&lt;start_index&gt;, &lt;points&gt;]</b> <b>FETC:CURR? [&lt;start_index&gt;, &lt;points&gt;]</b>
	To return instantaneous voltage or current data after the trigger indices: <b>FETC:ARR:VOLT? [&lt;start_index&gt;, &lt;points&gt;]</b> <b>FETC:ARR:CURR? [&lt;start_index&gt;, &lt;points&gt;]</b>

## Using Expression Signal Routing

This section describes how expressions can be used to program signal routing. You can also use the **Power Assistant software** to program signal routing. For an overview of how the expression signals are mapped into the trigger system, refer to **Trigger Overview**.

**Signal Routing Overview**

**Defining Signal Expressions**

**Configuring Threshold Comparators**

**Specifying Signal Expression Targets**

**Expression Constraints**

**Expression Examples**

### Signal Routing Overview

You can configure up to eight flexible, general purpose signal routing expressions. These signal expressions can be used to drive digital port pins, trigger measurements and transients, change output state, generate user-defined protection and user-defined status signals. Expressions are built using a large selection of signal inputs along with Boolean operators and programmable delays.

The following figure illustrates the signal routing paths:

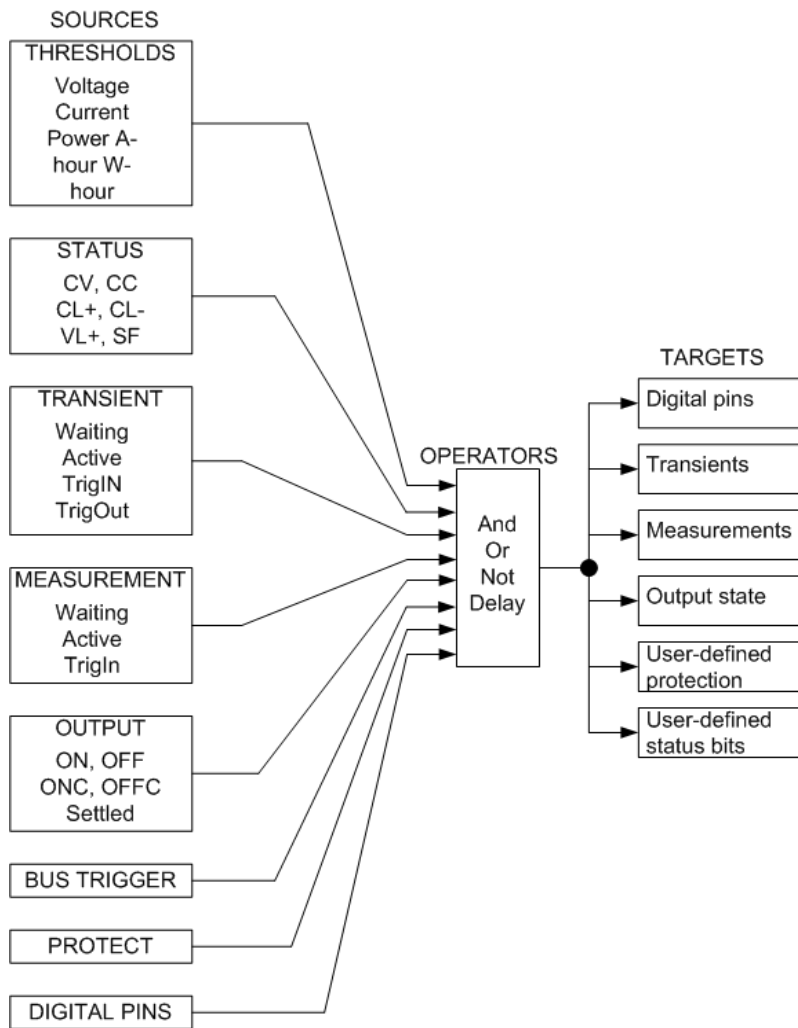

## Defining Signal Expressions

Use the following command to define signal expressions:

Front Panel Menu Reference	SCPI Command
Select <b>System\Signal\Define</b> .	To define signal expression number 1: <b>SYST:SIGN:DEF EXPR1,"expression"</b>
Select an expression number (1 to 8) in the dropdown list. Existing expressions will be displayed in the text field.	Define the "expression" using the available input parameters and operators.
Enter the expression using the available input names and operators in the text field (see below).	See <b>Examples</b> .

You can enter any value from the numeric keypad. For additional characters, use the up/down navigation keys to enter an alpha character by scrolling through the selection list that appears when you press the keys. Use the left/right navigation keys to traverse the text field. Use the backspace key to delete a value. Press Enter when you are finished.

Expressions must be enclosed in quotes ("" ) inside SCPI commands. Expressions are case-insensitive. You can enter alpha characters as all caps, all lowercase, or mixed case. Spaces must be included on either side of the Boolean operators And, Or, and Not. Spaces are not required around parentheses.

## 4 Using the Advanced Power System

The following table describes the available signal sources. The Type column describes the signal; an event generates a pulse; a state generates a level.

Signal Source	Type	Description
Thr<1-4>	state	Output of the SENSE:THReshold<1 2 3 4> comparators
WtgAcqTrig	state	The instrument is waiting for the acquisition trigger
WtgTranTrig	state	The instrument is waiting for the transient trigger
AcqActive	state	The acquisition is initiated or in progress
TranActive	state	The transient is initiated or in progress
AcqTrigIn	event	Pulses true when the acquisition trigger occurs
TranTrigIn	event	Pulses true when the transient trigger occurs
TranTrigOut	event	Pulses true when a trigger out signal occurs (by a step or list)
BusTrig	event	Pulses true when a bus trigger is received (either *TRG or GET)
DigPin<1-7>	state	A digital port pin (from 1 to 7)
OutpOn	state	The output state is on
OutpOff	state	The output state is off
OnC	event	Pulses true when the output is starting to turn on
OffC	event	Pulses true when the output is starting to turn off
OutpSettled	state	The output has reached the settled state
CV	state	The output is regulating in constant voltage mode
CC	state	The output is regulating in constant current mode
CL+	state	The output is in positive current limit
CL-	state	The output is in negative current limit
VL+	state	The output is in positive voltage limit
Prot	state	The output is disabled by an active protection function
OpenSense	state	The remote sense connections are open

The following Boolean operations (And, Or, Not), parentheses for grouping, and programmable delays can be applied to expression inputs.

Operator/Operation	Description
And, Or, Not	Boolean operations
()	Parentheses for grouping and nesting sub-expressions
Delay <sub-expression>, < time>,[<de-glitch>]	<p>Delays the signal described by expression. Suppresses positive pulses narrower than the de-glitch time parameter.</p> <p>Delays range from 0 to 167 seconds with these ranges:  0 to 0.02097 s with 1.28 us resolution  0.02097 to 0.167 s with 10.24 us resolution  0.167 to 1.677 s with 102.4 us resolution  1.677 to 16.776 s with 1.024 ms resolution  16.776 to 167.761 s with 10.24 ms resolution.</p> <p>De-glitch range is 0 to 85 seconds with 20 ns resolution.</p> <p>To program a de-glitch value without programming a delay, simply enter zero as the delay time.</p>

## Configuring Threshold Comparators

The APS models have four built-in level comparators that can generate an output signal based on the comparison of two input signals. These comparators can be set to measure one of five different parameters types and generate a signal based on whether the measured parameter is greater than or less than the specified level:

**VOLTage level** – The measured voltage level comparison

**CURRent level** – The measured current level comparison

**POWer level** – The measured power level comparison

**AHOur level** – The measured amp-hour level comparison

**WHOur level** – The measured watt-hour level comparison

The following commands define a comparison of the measured voltage to a pre-defined level of 10 V for comparator #1:

Front Panel Menu Reference	SCPI Command
Select <b>System\Signal\Threshold</b> .	To specify a voltage comparison for comparator 1: <b>SENS:THR1:FUNC VOLT</b>
Select the voltage comparator (1 - 4) from the Threshold dropdown list.	To specify a voltage threshold of 10 V: <b>SENS:THR1:VOLT:LEV 10</b>
Select one of 5 comparison parameters in the Function dropdown list (e.g. Voltage).	Define the comparator output to be true when the measured level is greater than (GT) 10 V: <b>SENS:THR1:FUNC GT</b>
Specify a threshold level in the Level field.	
Define the comparator output to be true when the measured level is either greater or less than the specified level.	
Select > or < in the Operation dropdown.	

## Specifying Signal Expression Targets

Signal expressions can be used to control digital port pins, specify trigger sources, control the OnCouple/OffCouple signals, create user-defined protection functions, and generate user-defined status signals.

### Digital Port Pins

To control digital port pins using expressions (see [Programming the Digital Port](#)):

Front Panel Menu Reference	SCPI Command
Select <b>System\IO\DigPort\Pins</b> .	To control a digital pins:
Select a pin in the Pin field.	<b>DIG&lt;1-7&gt;:FUNC EXPR&lt;1-8&gt;</b>
In the Function field, select the expression that will control the pin.	

### Trigger Sources

To set output transient and measurement trigger sources using expressions (see [Programming Transients](#) and [Making Measurements](#)):

Front Panel Menu Reference	SCPI Command
Select <b>Transient\TrigSource</b> .	To trigger transients using expressions:
Select the expression that will trigger the transient from Transient trigger source dropdown list.	<b>TRIG:TRAN:SOUR EXPR&lt;1-8&gt;</b>
Select the expression that will trigger the Arb from the CD Arb trigger source dropdown list.	To trigger Arbs using expressions:
Measurement trigger sources cannot be selected from the front panel.	<b>TRIG:ARB:SOUR EXPR&lt;1-8&gt;</b>
	To trigger measurements using expressions:
	<b>TRIG:ACQ:SOUR EXPR&lt;1-8&gt;</b>

### OnCouple/OffCouple Signals

To control the instrument's output state (on or off) using expressions:

Front Panel Menu Reference	SCPI Command
Select <b>System\Signal\Couple</b> .	To turn the output on using expressions:
Select the expression that will turn the output on from the On couple source dropdown list.	<b>OUTP:COUP:ON:SOUR EXPR&lt;1-8&gt;</b>
Select the expression that will turn the output off from the Off couple source dropdown list.	To turn the output off using expressions:
	<b>OUTP:COUP:OFF:SOUR EXPR&lt;1-8&gt;</b>

### User-Defined Protection

To set the user-defined protection source using expressions (see [Programming Output Protection](#)):

Front Panel Menu Reference	SCPI Command
Select <b>System\Signal\Protect</b> .	To set user-defined protection:
Select the expression that will set the user-defined protection from the Source dropdown list. Then check Enable.	<b>OUTP:PROT:USER:SOUR EXPR&lt;1-8&gt;</b>
	To enable user-protection:
	<b>OUTP:PROT:USER:STAT ON</b>

### User-Defined Status Events

To set the user-defined status bits using expressions (see [Status Overview](#)):

Front Panel Menu Reference	SCPI Command
Select <b>System\Signal&gt;Status</b> .	To set user-defined status bits:
Select the expression that will control the User1 status bit from the User1 status source dropdown list.	<b>STAT:OPER:USER&lt;1,2&gt;:SOUR EXPR&lt;1-8&gt;</b>
Select the expression that will control the User2 status bit from the User2 status source dropdown list.	

### Expression Constraints

There is a limit to the total number of expressions and delays that can be programmed.

- A maximum of 8 expressions may be created (EXPR<1-8>).
- A maximum of 11 **different** inputs can be used across all expressions.
- A maximum of eight delays can be used across all expressions.
- Delays cannot be nested.
- Combining delays with other operators reduces the number of available expressions. Each **additional** input or sub-expression that is combined with a delay using AND or OR, reduces the number of remaining available expressions by one.

In the following expression, because the delay is ORed with another input, the maximum number of remaining available expressions is six.

Front Panel Menu Reference	SCPI Command
Select <b>System\Signal\Define</b> .	Program the signal expression.
Select Expression 1 in the dropdown list.	<b>SYST:SIGN:DEF EXPR1, "Delay(CV,1) Or CC"</b>
Enter "Delay(CV,1) Or CC" in the text field.	

In the following expression, because the delay is ORed with two inputs, the maximum number of remaining available expressions is five.

Front Panel Menu Reference	SCPI Command
Select <b>System\Signal\Define</b> . Select Expression 1 in the dropdown list. Enter "Delay(CV,1) Or CC Or DigPin1" in the text field.	Program the signal expression. <b>SYST:SIGN:DEF EXPR1, "Delay(CV,1) Or CC Or DigPin1"</b>

In the following expression, because the delay is ORed with one sub-expression, the maximum number of remaining available expressions is six.

Front Panel Menu Reference	SCPI Command
Select <b>System\Signal\Define</b> . Select Expression 1 in the dropdown list. Enter "Delay(CV,1) Or (CC And DigPin1)" in the text field.	Program the signal expression. <b>SYST:SIGN:DEF EXPR1, "Delay(CV,1) Or (CC And DigPin1)"</b>

To put it another way, if the above three expressions (Examples 5-7) were all created, you would have only one more expression available for use.

## Expression Examples

**Example 1** Create a digital signal on pin1 of the digital port that is true whenever the output is in positive or negative current limit:

Front Panel Menu Reference	SCPI Command
Select <b>System\Signal\Define</b> . Select Expression 1 in the dropdown list. Enter "CL+ Or CL-" in the text field.  You can enter any value from the numeric keypad. For additional characters, use the up/down navigation keys to enter an alpha character by scrolling through the selection list that appears when you press the keys. Use the left/right navigation keys to traverse the text field. Use the backspace key to delete a value. Press Enter when you are finished.  Select <b>System\IO\DigPort\Pins</b> . Select pin 1 in the Pin field. In the Function field, select Expr 1.	Program the signal expression. <b>SYST:SIGN:DEF EXPR1, "CL+ Or CL-"</b>  Program the digital pin. <b>DIG:PIN1:FUNC EXPR1</b>

**Example 2** Create a trigger source that will trigger an output transient (step or list) whenever the output current is between 2.1 A and 2.7 A:

Front Panel Menu Reference	SCPI Command
Select <b>System\Signal\Threshold</b> .	Program the threshold comparators. (GT = greater than; LT = less than)
Select voltage comparator 1 (Threshold 1) from the dropdown list. Select Current from the Function list. Enter 2.1 in the Level field. Select > from the Operation list.	<b>SENS:THR1:FUNC CURR</b>
Select voltage comparator 2 (Threshold 2) from the dropdown list. Select Voltage from the Function list. Enter 2.7 in the Level field. Select < from the Operation list.	<b>SENS:THR2:FUNC CURR</b>
Select <b>System\Signal\Define</b> .	<b>SENS:THR1:CURR 2.1</b>
Select Expression 2 in the dropdown list.	<b>SENS:THR2:CURR 2.7</b>
Enter "THR1 And THR2" in the text field.	<b>SENS:THR1:OPER GT</b>
You can enter any value from the numeric keypad. For additional characters, use the up/down navigation keys to enter an alpha character by scrolling through the selection list that appears when you press the keys. Use the left/right navigation keys to traverse the text field. Use the backspace key to delete a value. Press Enter when you are finished.	<b>SENS:THR2:OPER LT</b>
Select <b>Transient\TrigSource</b> .	Program the signal expression.
Select Expr2 from the Transient trigger source list.	<b>SYST:SIGN:DEF EXPR2, "THR1 And THR2"</b>
	Program the output trigger source.
	<b>TRIG:TRAN:SOUR EXPR2</b>

**Example 3** Create a custom protection that will disable the output if the output voltage moves outside the window between 23.5 V and 24.5 V:

Front Panel Menu Reference	SCPI Command
Select <b>System\Signal\Threshold</b> .	Program the threshold comparators. (GT = greater than; LT = less than)
Select voltage comparator 3 (Threshold 3) from the dropdown list. Select Voltage from the Function list. Enter 23.5 in the Level field. Select < from the Operation list.	<b>SENS:THR3:FUNC VOLT</b>
Select voltage comparator 4 (Threshold 4) from the dropdown list. Select Voltage from the Function list. Enter 24.5 A in the Level field. Select > from the Operation list.	<b>SENS:THR4:FUNC VOLT</b>
Select <b>System\Signal\Define</b> .	<b>SENS:THR3:VOLT 23.5</b>
Select Expression 3 in the dropdown list.	<b>SENS:THR4:VOLT 24.5</b>
Enter "THR3 Or THR4" in the text field.	<b>SENS:THR3:OPER LT</b>
You can enter any value from the numeric keypad. For additional characters, use the up/down navigation keys to enter an alpha character by scrolling through the selection list that appears when you press the keys. Use the left/right navigation keys to traverse the text field. Use the backspace key to delete a value. Press Enter when you are finished.	<b>SENS:THR4:OPER GT</b>
Select <b>System\Signal\Protect</b>	Program the signal expression.
Select Expr3 from the dropdown list. Then select Enable.	<b>SYST:SIGN:DEF EXPR3, "THR3 Or THR4"</b>
	Program the output protection state.
	<b>OUTP:PROT:USER:SOUR EXPR3</b>
	<b>OUTP:PROT:USER:STAT ON</b>

**Example 4** Create a trigger source that triggers a measurement 50 milliseconds after the output has settled..

Front Panel Menu Reference	SCPI Command
<p>Select <b>System\Signal\Define</b>.</p> <p>Select Expression 4 in the dropdown list.</p> <p>Enter "Delay(OutpSettled, 0.05)" in the text field.</p> <p>You can enter any value from the numeric keypad. For additional characters, use the up/down navigation keys to enter an alpha character by scrolling through the selection list that appears when you press the keys. Use the left/right navigation keys to traverse the text field. Use the backspace key to delete a value. Press Enter when you are finished.</p>	<p>Program the signal expression.</p> <p><b>SYST:SIGN:DEF EXPR4, "Delay (OutpSettled,0.05)"</b></p> <p>Program the measurement trigger source.</p> <p><b>TRIG:ACQ:SOUR EXPR4</b></p>

## Programming the Digital Port

### Bi-Directional Digital I/O

### Digital Input only

### Expression Output

### External Trigger I/O

### Fault Output

### Inhibit Input

### Fault/Inhibit System Protection

### Output Couple

## Digital Control Port

A Digital Control Port consisting of seven I/O pins is provided to access various control functions. Each pin is user-configurable. The following control functions are available for the I/O pins. See [SCPI Programming Reference](#) for details on the SCPI commands to program the Digital Port.

The following table describes the possible pin configuration for the digital port functions. For a complete description of the electrical characteristics of the digital control port, refer to the [Specifications](#) section.

Function	Description
DIO	General-purpose ground-referenced digital input/output function. The output can be set with [SOURCE:]DIGital:OUTPut:DATA.
DINPut	Digital input-only mode. The digital output data of the pin is ignored.
EXPRession<1-8>	A user-defined expression drives the pin.
FAULT	Applies only to pin 1. Pin 1 functions as an isolated fault output. The fault signal is true when any output is in a protected state. Pin 2 serves as the isolated common for pin 1. When pin 1 is set to the FAULT function, the instrument ignores any commands to program pin 2. Queries of pin 2 will return FAULT. If pin 1 is changed from FAULT to another function, pin 2 is set to DINPut.
INHibit	Applies only to pin 3. When pin 3 is configured as an inhibit input; a true signal at the pin will disable the output.
ONCouple	Applies only to pins 4-7. The ONCouple pin synchronizes the output On state between instruments. Only one pin can be configured as an ONCouple. The pin functions as both an input and an output.
OFFCouple	Applies only to pins 4-7. The OFFCouple pin synchronizes the output Off state between instruments. Only one pin can be configured as an OFFCouple. The pin functions as both an input and an output.

TINPut	A trigger input pin can be selected as the source for measurement and transient trigger signals. See <b>TRIGger:ACQuire:SOURce</b> and <b>TRIGger:TRANSient:SOURce</b>
TOUTPut	A trigger output pin will generate output triggers from any subsystem that has been configured to output trigger signals.
Common	Applies only to pin 8. Connected to ground.

In addition to the configurable pin functions, the signal polarity (Positive or Negative) for each pin is also configurable. For level signals, POSitive indicates a voltage high at the pin. NEGative indicates a voltage low at the pin. For edge signals, POSitive means a rising edge and NEGative means a falling edge.

### Bi-Directional Digital I/O

Each of the seven pins can be configured as general purpose bi-directional digital inputs and outputs. The polarity of the pins can also be configured. Pin 8 is the signal common for the digital I/O pins. Data is programmed according to the following bit assignments:

Pin	7	6	5	4	3	2	1
Bit Weight	6 (msb)	5	4	3	2	1	0 (lsb)

The digital I/O pin can be used to control both relay circuits as well as digital interface circuits. The following figure illustrates typical relay circuits as well as digital interface circuit connections using the digital I/O functions

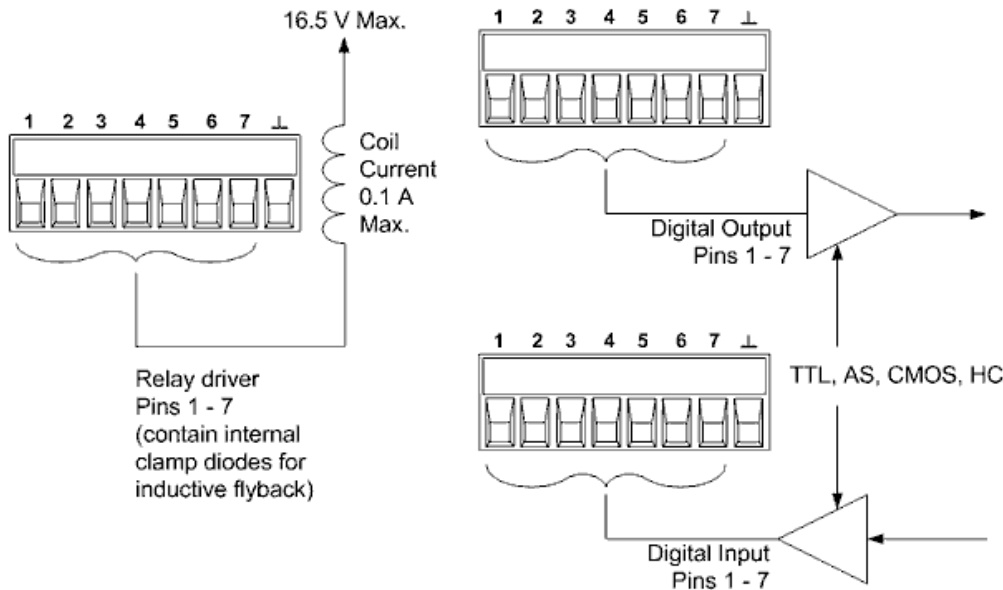

To configure the pins for digital I/O:

Front Panel Menu Reference	SCPI Command
Select <b>System\IO\DigPort\Pins</b> .	To select the pin function: <b>DIG:PIN&lt;1-7&gt;:FUNC DIO</b>
Select a pin in the Pin field.	
In the Function field, select Dig IO.	To select pin polarity: <b>DIG:PIN&lt;1-7&gt;:POL POS</b>
In the Polarity field, select either Positive or Negative.	
To send data to the pins, select <b>System\IO\DigPort\Data</b> .	To configure pins 1 through 7 as "0000111": <b>DIG:OUTP:DATA 7</b>
Select the Data Out field and enter the binary word.	

## Digital Input

Each of the seven pins can be configured as digital input only. The polarity of the pins can also be configured. Pin 8 is the signal common for the digital input pins. The pin status reflects the true condition of the external signal that is applied to the pin. The pin state is not affected by the setting of DIGital:OUTPut:DATA. To configure the pins for digital input only:

Front Panel Menu Reference	SCPI Command
Select <b>System\IO\DigPort\Pins</b> .	To select the pin function: <b>DIG:PIN&lt;1-7&gt;:FUNC DINP</b>
Select a pin in the Pin field.	
In the Function field, select <b>Dig In</b> .	To select pin polarity: <b>DIG:PIN&lt;1-7&gt;:POL POS</b>
In the Polarity field, select either Positive or Negative.	
To read the data from the pins, select <b>System\IO\DigPort\Data</b> .	To read the data on the pins: <b>DIG:INP:DATA?</b>
The input data is displayed as a binary number in the Data In field.	

## Expression<1-8>

### NOTE

Refer to [Using Expression Signal Routing](#) for a complete description of the instrument's signal routing capability.

Each of the seven pins can be configured to have one of eight user-defined expressions drive the pin. The polarity of the pins can also be configured. Pin 8 is the signal common for the expression pins. To configure the pins for expressions:

Front Panel Menu Reference	SCPI Command
Select <b>System\IO\DigPort\Pins</b> .	To select the pin function: <b>DIG:PIN&lt;1-7&gt;:FUNC EXPR1</b>
Select a pin in the Pin field.	
In the Function field, select one of the 8 EXPRession functions.	To select pin polarity: <b>DIG:PIN&lt;1-7&gt;:POL POS</b>
In the Polarity field, select either Positive or Negative.	

## External Trigger I/O

Each of the seven pins can be configured as trigger inputs or trigger outputs. The polarity of the pins can also be configured. When you program trigger polarity, POSitive means a rising edge and NEGative means a falling edge. Pin 8 is the signal common for the trigger pins. For an overview of the trigger system, refer to [Trigger Overview](#).

When configured as a trigger input, you can apply either a negative-going or a positive-going pulse to the designated trigger input pin. The trigger latency is 5 microseconds. The minimum pulse width is 4 microseconds for positive-going signals, and 10 microseconds for negative-going signals. The pin's polarity setting determines which edge generates a trigger-in event.

When configured as a trigger output, the designated trigger pin will generate a 10 microsecond-wide pulse when a Trigger Out occurs. Depending on the polarity setting, it can be either positive-going (rising edge) or negative-going (falling-edge) when referenced to common.

Front Panel Menu Reference	SCPI Command
Select <b>System\IO\DigPort\Pins</b> .	To select the trigger output function for pin 1: <b>DIG:PIN1:FUNC TOUT</b>
Select a pin in the Pin field.	
In the Function field, select either the Trig In or Trig Out function.	To select the trigger input function for pin 2: <b>DIG:PIN2:FUNC TINP</b>
In the Polarity field, select either Positive or Negative.	To select the pin polarity: <b>DIG:PIN1:POL POS</b> <b>DIG:PIN2:POL POS</b>

## Fault Output

Pins 1 and 2 can be configured as a fault-output pair. The Fault Output function enables a fault condition to generate a protection fault signal on the digital port. Refer to [Programming Output Protection](#) for a list of protection signals.

Both pins 1 and 2 are dedicated to this function. Pin 1 is the Fault output; pin 2 is the common for pin 1. This provides for an optically-isolated output. The polarity of pin 1 can also be configured. When the pin polarity is POSitive, a fault condition causes the isolated output to conduct. Note that the Fault output signal remains latched until the fault condition is removed and the protection circuit is cleared, as explained under [Clearing Protection Functions](#).

### NOTE

Pin 2's selected function is ignored. Pin 2 should be connected to the ground of the external circuit.

Front Panel Menu Reference	SCPI Command
Select <b>System\IO\DigPort\Pins</b> .	To configure the Fault function: <b>DIG:PIN1:FUNC FAUL</b>
Select pin 1, then Function, then Fault Out.	
In the Polarity field, select either Positive or Negative.	To select the pin polarity: <b>DIG:PIN1:POL POS</b>

## Inhibit Input

Pin 3 can be configured as a remote inhibit input. The Inhibit Input function lets an external input signal control the output state of instrument. The input is level triggered. The signal latency is 5 microseconds. Pin 8 is the common for pin 3.

The following non-volatile inhibit input modes can be programmed:

**LATChing** - causes a logic-true transition on the Inhibit input to disable the output. The output will remain disabled after the inhibit signal is received.

**LIVE** - allows the enabled output to follow the state of the Inhibit input. When the Inhibit input is true, the output is disabled. When the Inhibit input is false, the output is re-enabled.

**OFF** - The Inhibit input is ignored.

To configure the Inhibit Input function:

Front Panel Menu Reference	SCPI Command
Select <b>System\IO\DigPort\Pins</b> .	To select the Inhibit function: <b>DIG:PIN3:FUNC INH</b>
Select pin 3, then Function, then Inhibit In.	
In the Polarity field, select either Positive or Negative.	To select the pin polarity: <b>DIG:PIN3:POL POS</b>
Select <b>Protect\Inhibit</b> .	
Select either Latching or Live.	To set Inhibit mode to Latching: <b>OUTP:INH:MODE LATC</b>
To disable the Inhibit signal, select Off.	To set Inhibit mode to Live: <b>OUTP:INH:MODE LIVE</b>
	To disable the Inhibit signal: <b>OUTP:INH:MODE OFF</b>

## Fault/Inhibit System Protection

As shown in the following figure, when the Fault outputs and Inhibit inputs of several instruments are daisy-chained, an internal fault condition in one of the units will disable all outputs without intervention by either the controller or external circuitry. Note that when using the Fault/Inhibit signals in this manner, both signals must be set to the same polarity.

Also, as shown in the figure, you can also connect the Inhibit input to a manual switch or external control signal that will short the Inhibit pin to common whenever it is necessary to disable all outputs. **Negative** polarity must be programmed for all pins in this case. You can also use the Fault output to drive an external relay circuit or signal other devices whenever a protection fault occurs.

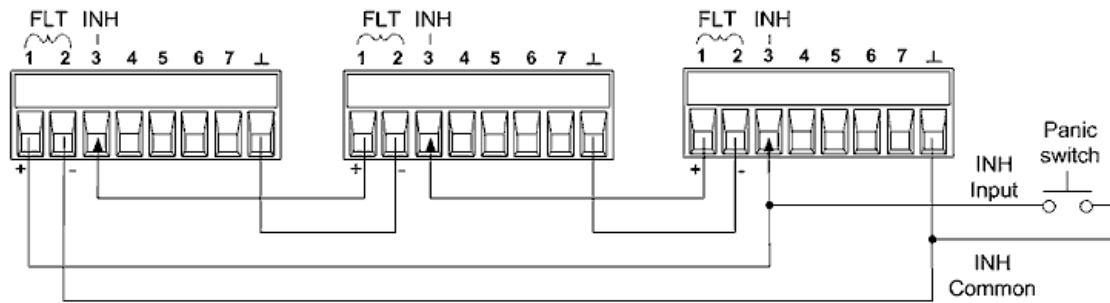

## Clearing a System Protection Fault

To restore all instruments to a normal operating condition when a fault condition occurs in a daisy-chained system protection configuration, two fault conditions must be removed:

1. The initial protection fault or external Inhibit signal.
2. The subsequent daisy-chained fault signal (which is sourced by the Inhibit signal).

**NOTE**

Even when the initial fault condition or external signal is removed, the fault signal is still active and will continue to shut down the outputs of all the units.

To clear the daisy-chained fault signal if the operating mode of the Inhibit input is Live, simply clear the output protection on any ONE unit as explained under **Clearing Protection Functions**. If the operating mode of the Inhibit input is Latched, turn off the Inhibit input on ALL units individually. To re-enable the chain, re-program the Inhibit input on each unit to Latched mode.

## Output Couple Control

This function lets you connect multiple instruments together and synchronize the output on/off sequence across all units. Each unit that will be sequenced must also be "coupled" to the other units.

1. Couple the output on each unit as described under **Sequencing the Output**.
2. Set the delay offset of each individual unit to match the longest delay offset of the group.
3. Connect and configure the digital connector pins of the sequenced units as shown below.

Only pins 4 through 7 can be configured as "coupled" pins. The designated pins will function as both an input and an output, with a negative transition on one pin providing the sequence signal to the other pins. The polarity of the pins is not programmable; it is set to NEGative.

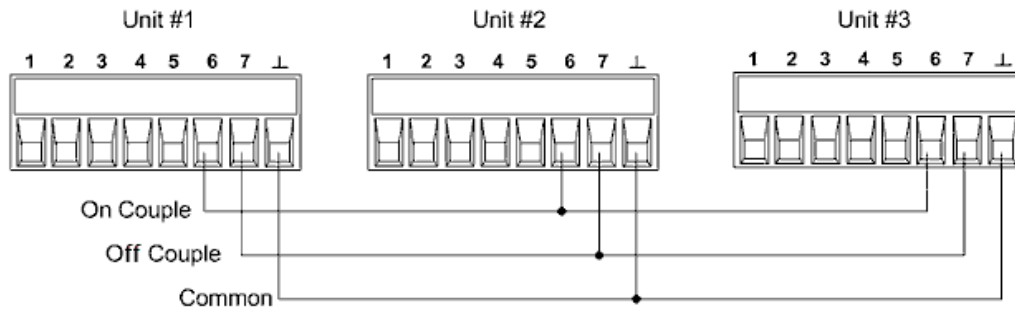

In this example, pin 6 is configured as the output On control. Pin 7 is configured as the output Off control. The ground or Common pins are connected together.

Front Panel Menu Reference	SCPI Command
Select <b>System\IO\DigPort\Pins</b> .	To set pin 6 of unit 1 as the ON control:
Select pin 6, then Function, then On Couple.	<b>DIG:PIN6:FUNC ONC</b>
Select <b>Pins</b> ., select pin7, then Function, then Off Couple.	To configure pin 7 of unit 1 as the OFF control:
Repeat these steps for units #2 and #3	<b>DIG:PIN7:FUNC OFFC</b>
	Repeat these commands for units 2 and 3.

Once configured and enabled, turning the output on or off on any coupled unit will cause all coupled units to turn on or off according to their user-programmed delays.

## External Data Logging (Elog)

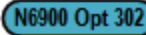
Select the Measurement Function and Range

Specify the Integration Period

Select the Elog Trigger Source

Initiate and Trigger the Elog

Periodically Retrieve the Data

Terminate the Elog

### External Data Logging

**NOTE**

The external data logging function can only be programmed using SCPI commands.

The Keysight N7900 models have an "external" data logging function (Elog) that lets you continuously log voltage and current measurements. Data logging is external to the instrument because it can only be implemented using SCPI commands. Voltage and current measurement data is temporarily stored in a FIFO (first-in, first-out) buffer located in the instrument. However, this buffer is only large enough to hold about 20 seconds of accumulated measurements. This means that you must periodically empty the internal buffer to an external storage device; otherwise the data in the buffer will be overwritten.

The following table details the various data logging functions.

Function	Description
Data Storage	Buffers measurements for about 20 seconds and requires that the computer periodically reads measurements to prevent the internal buffer from overflowing. The computer needs to provide the external data storage.
Measurement Functions	Both output voltage and output current can be logged.
Integration Period	Minimum integration period is 102.4 microseconds for one parameter with data format set to REAL. During the specified integration period, the samples are averaged, and min and max values are tracked.
Data viewing	No front panel view or control. Data is collected and viewed externally.

Note that the Elog function uses the **acquire trigger process** to make the measurements.

### Select the Measurement Function and Range

The following commands select a measurement function:

Front Panel Menu Reference	SCPI Command
Not available	To enable voltage or current measurements: <b>SENS:ELOG:FUNC:VOLT ON</b> <b>SENS:ELOG:FUNC:CURR ON</b>
	To enable min/max measurements: <b>SENS:ELOG:FUNC:VOLT:MINM ON</b> <b>SENS:ELOG:FUNC:CURR:MINM ON</b>

Keysight N7900 models have two current measurement ranges, a high and a low range (see [specifications](#)). A seamless current ranging function ensures that no data is lost due to range switching. Seamless ranging is enabled by default. The commands to enable seamless current measurement ranging are:

Front Panel Menu Reference	SCPI Command
Not available	To enable seamless elog autoranging: <b>SENS:ELOG:CURR:RANG:AUTO ON</b>

## Specify the Integration Period

The integration period can be set from a minimum of 102.4 microseconds to a maximum of 60 seconds.

Front Panel Menu Reference	SCPI Command
Not available	To set an integration period of 600 microseconds: <b>SENS:ELOG:PER 0.0006</b>

During the integration period, Elog samples are averaged, and the minimum and maximum values are tracked. At the end of each integration period the average, minimum, and maximum values are added to the internal FIFO buffer.

Although the absolute minimum integration period is 102.4 microseconds, the actual minimum depends on the number of measurements that are being logged. The formula is  $102.4_{\text{microseconds}} \times \#_{\text{of\_measurements}}$ . For example:

- 102.4 microseconds:** 1 measurement (voltage or current)
- 204.8 microseconds:** 2 measurements (voltage and current)
- 409.6 microseconds:** 4 measurements (voltage+min+max+current)

If the specified integration period is at or near the minimum logging intervals, the data format must be specified as binary. If the REAL format is not specified, the data will be in ASCII format and the minimum logging intervals will typically be up to five times longer than what can be achieved with binary format.

Front Panel Menu Reference	SCPI Command
Not available	To set the data format to REAL: <b>FORM[:DATA] REAL</b>

## Select the Elog Trigger Source

The TRIGger:ELOG command generates an immediate trigger regardless of the trigger source. Unless you are using this command, select a trigger source from the following:

Trigger Source	Description
Bus	Selects GPIB device trigger, *TRG, or <GET> (Group Execute Trigger).
External	Selects ANY pin that is configured as a Trigger Input on the digital control port.
Immediate	Triggers the transient as soon as it is INITiated.
Pin<1-7>	Selects a specific pin that is configured as a Trigger Input on the digital control port.

Use the following commands to select one of the available trigger sources:

Front Panel Menu Reference	SCPI Command
Not available	To select Bus triggers: <b>TRIG:TRAN:SOUR BUS</b>
	To select digital pin 5 as the trigger: <b>TRIG:ACQ:SOUR PIN5</b>
	To select expression1 as the trigger: <b>TRIG:ACQ:SOUR EXPR1</b>

## Initiate and Trigger the Elog

When the power supply is turned on, the trigger system is in the Idle state. In this state, the trigger system is disabled, ignoring all triggers. The INITiate command enables the measurement system to receive triggers. To initiate and trigger the Elog:

Front Panel Menu Reference	SCPI Command
Not available	To initiate the Elog: <b>INIT:ELOG</b>
	To trigger the Elog: <b>TRIG:ELOG</b>
	Alternatively, if the trigger source is BUS, you can also program a *TRG or an IEEE-488 <get> command.

When triggered, the Elog starts placing data in the internal measurement buffer. Because the buffer is only large enough to hold 20 seconds of accumulated measurement your PC application must periodically retrieve (or fetch) the data from this buffer.

## Periodically Retrieve the Data

Each FETCh command returns number of requested records of the data in the buffer and removes them, making room available for more data. The Elog continues until it is aborted.

An Elog record is one set of voltage and current readings for one time interval. The exact format of a record depends on which functions have been enabled for Elog sensing. If all functions are enabled, then one record will contain the following data in the specified order:

Current average  
 Current minimum  
 Current maximum  
 Voltage average  
 Voltage minimum  
 Voltage maximum

Front Panel Menu Reference	SCPI Command
Not available	To retrieve a maximum of 1000 records: <b>FETC:ELOG? 1000</b>

ASCII data (the default format) is returned as comma-separated ASCII numeric data sets of average/min/max values terminated by a newline. REAL data is returned as a definite length block, with the byte order specified by the FORMat:BOReR command.

## Terminate the Elog

Front Panel Menu Reference	SCPI Command
Not available	To abort the Elog: <b>ABOR:ELOG</b>

## Black Box Data Recording

### Black Box Recorder

### Logged Data

### BBR Status

### BBR Period

### BBR Length

### Snapshot Operation

### Snapshot Event Tags

### BBR Clock Setup

### BBR Alignment

## Black Box Recorder

The N7908A Black Box Recorder is an option that performs continuous background logging of output voltage, current, power, and system status to its own dedicated mass storage device.

On units with serial numbers MY59100101 and up, the Black Box Recorder is available as Option BBR. On units with prior serial numbers, the N7908A Black Box Recorder accessory board installs in an access port on the bottom of the chassis. Refer to **Black Box Recorder** installation.

#### NOTE

You must use the **Power Assistant software** to view the BBR data after a **snapshot operation**. You cannot view BBR data on the front panel or view the data using SCPI commands.

The following list describes the key attributes of the BBR function:

- The BBR is discovered at power-on and is automatically enabled. If the BBR is not present or working, a self-test error is generated and logging is disabled. Refer to **BBR Status**.
- Logging starts automatically when the unit is turned on and does not interfere with any source or measurement functions of the unit. Logging is done to a circular queue of approximately 380 MB.
- Two available logging rates are: one record every 10 ms, or one record every 100 ms. The 10 ms rate saves 24 hours of data before the queue overwrites. The 100 ms rate saves 10 days of data before the queue overwrites.
- Logging never stops while the unit is on except when the logging rate or the real-time clock settings are changed. In these cases, logging is paused and restarted. Logging also stops when a Power-fail protection occurs. In this case logging only resumes after output protection is cleared by the user when AC power returns.

- Logged data is preserved after a power cycle. A time-stamped event is logged each time power is turned on.

## Logged Data

The following output measurements are automatically logged per data record:

Average voltage	Average current	Average power
Maximum voltage	Maximum current	Maximum power
Minimum voltage	Minimum current	Minimum power

Status bits and events are also logged into the BBR. Refer to [Questionable Status Group](#) for status definitions. You can select the status items using the [Power Assistant software](#).

## BBR Status

To check the status of the Black Box Recorder:

Front Panel Menu Reference	SCPI Command
Select <b>System\BBR&gt;Status</b>	<b>SYST:BBR:STAT?</b>
A message displays the BBR status.	Returns true if the BBR is logging.

When the BBR drive has been removed from the access port on the bottom of the chassis, the status message indicates: "BBR is enabled but drive was not detected. If removed, disable to stop error messages". To disable subsequent self-test errors and remove the BBR option from the instrument's option list, press the Disable button that appears on the display. The status message will then indicate "BBR is not installed".

## BBR Period

To specify the logging period:

Front Panel Menu Reference	SCPI Command
Select <b>System\BBR\Period</b>	<b>SENS:BBR:PER 0.1</b>
Select either 10 ms or 100 ms.	Specifies a period of 100 ms.

## BBR Length

To return the length of the BBR data:

Front Panel Menu Reference	SCPI Command
Select <b>System\BBR\Snapshot</b>	<b>SYST:BBR:TIME?</b>
The length of the BBR data in hours is displayed in the Logged Data field.	Returns length of the BBR data in seconds.

## Snapshot Operation

- It is good practice to verify the system date and time before retrieving Black Box data. Refer to **BBR Clock Setup**.
- You can retrieve logged data by requesting a "snapshot" either from the front panel or using SCPI commands. Snapshot operation can take up to 1 minute. On the front panel, the snapshot time is specified in hours and percent of hours. In SCPI, the time is specified in seconds.
- You cannot request another snapshot while one is already in progress.
- The snapshot always uploads from the most recent data entry on back.
- Snapshot copies the specified data into separate data and event files.
- Snapshot files can be retrieved and viewed on a PC using the **Power Assistant software**.

To make a snapshot of the recorded data:

Front Panel Menu Reference	SCPI Command
Select <b>System\BBR\Snapshot</b>	<b>SYST:BBR:SNAP 5400</b>
Enter a time period in the Snapshot field. For example, 1.5 would be one and a half hours. Select Enter. Then select Snapshot.	Specify the time period in seconds. For example, 5,400 seconds specifies a time period of one and a half hours.
The Status field displays the percent completion of the snapshot operation.	To return the percent snapshot completion, use: <b>SYST:BBR:SNAP:STAT?</b>

## Snapshot Event Tags

The BBR has a separate event log that is synchronized with data log. You can add user-defined event tags to the BBR data. This can only be accomplished via SCPI commands, and not from the front panel.

- The BBR event file log has room for 100,000 event strings.
- The maximum length of the event string is 55 characters.
- Events that are older than the oldest BBR data are deleted.
- Data logging is not paused for an event log.

The event is logged as soon as the event command is received. To add an event to the event log:

Front Panel Menu Reference	SCPI Command
Not available	<b>SYST:BBR:EVEN "Starting Test ABC at 10:05:02"</b> Places the quoted text into the event log.

## BBR Clock Setup

The real-time clock is used to time-stamp the BBR, which is its only function. When shipped, the real-time clock is set to Greenwich mean time. To set the clock:

Front Panel Menu Reference	SCPI Command
Select <b>System\Preferences\Display\Clock</b> .	To set the date: <b>SYSTem:DATE</b>
Enter the date in the Month, Day and Year fields. Enter the time in the Hour, Minute, and Second fields. Press Select to set the date and time.	To set the time: <b>SYSTem:TIME</b>

### NOTE

There will be a slight gap/discontinuity of less than 1 second in the BBR record when the clock is set.

## BBR Alignment

If the BBR option is installed, it is recommended that you align the real-time clock in the power supply with the clock on your computer/controller before you perform any critical activity or test. This will remove any error due to long term clock drifting.

### Clock Drift

The real-time clock's time base has a tolerance of  $\pm 100$  ppm. This causes the time base to steadily drift in relation to a perfect time reference. The following table illustrates this effect on long term BBR measurements. Note that drift times apply to both 10 ms and 100 ms logging rates.

Logging Time	Drift
1 hour	$\pm 0.36$ seconds
1 day	$\pm 8.64$ seconds
10 days (requires 100 ms logging rate)	$\pm 86.4$ seconds

### BBR Alignment Methods

**Method 1**– Set the real-time clock using the front panel or SCPI command as described above under Real Time Clock Setup. Note that there is no automated way to synchronize the RTC to NIST, TIME.GOV, or other internet clock sources. There is no external clock input to set the real-time clock. Once the real time clock has been set on multiple units, mis-alignment of the BBR records between units will be minimized.

**Method 2**– Send a text message (event tag) into the BBR record using the SCPI **SYSTem:BBR:EVENT "message"** command. With this command, you can write a text record into the BBR log to mark a particular time in the record. For example, you can send the following text message into the event log "Starting Test ABC at 10:05:02". Each BBR record is logged every 10 ms (or 100 ms), so the message alignment should be within 1–2 records or 10–20 ms of the logged data, depending on how fast you

## 4 Using the Advanced Power System

can read and send the time to the instrument. By sending this event tag to several units, you can create a common event tag to align all BBR records.

**Method 3-** Send a digital pulse into a digital input pin on the rear of the power supply (see **Digital Input**). This digital pulse will be detected and can be setup to trigger a user-defined status bit. See **Using Expression Signal Routing**. All status bits, including the user-defined status bit, are recorded in the BBR log. This will locate the pulse to within 10 ms, as the BBR is logged every 10 ms (or 100 ms). By sending this pulse into several units, you can create a common event tag to align all BBR records. Of course, you can combine these last two methods and also tag the digital pulse with a text message in the log to record the meaning of that particular pulse.

## Current Sharing Operation

**Enable the Current Sharing Function**

**Program the On Couple and Off Couple Function**

**Program the Output Voltage and Current**

**Program a Step Function for Additional Output Changes**

**Enable the Output and Trigger the Additional Output Changes**

**Specification Effects**

**Current Sharing Effects**

### Introduction

#### CAUTION

**Equipment Damage** For parallel operation, only connect power supplies that have the same voltage rating.

Current sharing is an analog control function that fine-tunes the output voltage up to about 0.5% of the unit's voltage rating, so that multiple units may be paralleled when operating in voltage or current priority mode. In this way, models having the same voltage rating can share current equally among participating units.

The current sharing setup consists of paralleling the output terminals and connecting the Sharing cable as described under **Parallel Connections**. The Sharing cable provides the analog signal that allows units of the same voltage rating to share current equally.

You must also connect and program the output On Couple and Off Couple digital port signals to provide synchronized instrument turn-on and turn-off capability.

Finally, you must also use the transient step generator to program any subsequent output voltage (or current) values so that all programmed changes will be synchronized across units. Configure one of the digital port pins to generate and receive the Step trigger.

The following list details the current sharing operation.

- Connect no more than five units **of identical voltage ratings** in parallel.
- Do not parallel N6900 models with N7900 models.
- If any paralleled units are turned on or off while current sharing, the load current will automatically be shared among the remaining active units, provided that the required load current is within the current capability of the remaining units.
- Units of mixed power (1 kW and 2 kW) with the same voltage rating can participate in current sharing. This lets you take advantage of the higher current capability of the 2 kW units.
- To determine the total load current, you must sum the output current readings of the individual paralleled units.

**CAUTION**

**Equipment Damage** Always turn the **AC power** on and off together. Never leave any units powered on while the others are off. If AC power is turned on or off on a single coupled unit, the outputs of the remaining units that are still powered on will be enabled and will transition to their programmed settings. To prevent this from happening, program the outputs of all coupled units to zero before powering them off, and always turn AC power on or off together on all coupled units.

The following list details the **current dissipating requirements** for units that are connected in parallel. This assures that current-sharing is maintained throughout both sourcing and sinking operating quadrants.

- For **identical power-rated** models with no dissipator – all units will share current equally.
- For **identical power-rated** models with dissipators – all units require equivalent current dissipation capability. For example, if you have a 2 kW unit with one dissipator, each paralleled unit requires one dissipator to current-share correctly. If you have a 2 kW unit with two dissipators, each paralleled unit requires two dissipators to share current equally.
- For **dissimilar power-rated** models (1 kW and 2 kW units) with no dissipators – all units will share current proportionately.
- For **dissimilar power-rated** models (1 kW and 2 kW units) with dissipators – all units require current-dissipation capability equal to the full output-rating of the unit. For example, if you have a 1 kW unit with one dissipator in parallel with a 2 kW unit, the 2 kW unit requires two dissipators to share current proportionately.

### Enable the Current Sharing Function

This lets you configure the units for parallel or non-parallel operation with the current sharing cable installed. When current sharing is enabled, the front panel status indicator displays a "P", indicating that the sharing function has been enabled and the sharing relay has closed to connect the instrument to the Sharing bus.

Front Panel Menu Reference	SCPI Command
Select <b>Output\Advanced\CurrSharing</b> Check Enable current sharing to enable.	To enable current sharing: <b>CURR:SHAR ON</b>

**NOTE**

When the output is disabled, the sharing relay automatically opens and disconnects the unit from the Sharing bus.

### Program the On Couple and Off Couple Function

Refer to **Output Couple Control** for details. Connect the On Couple and Off Couple signal to the paralleled units as shown in the following figure:

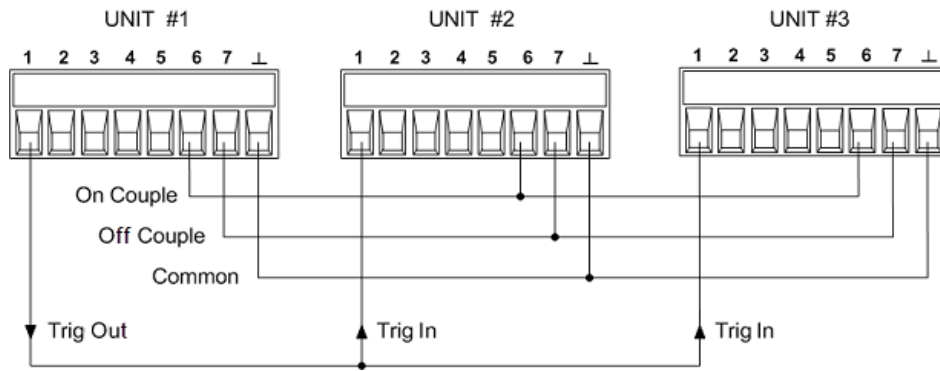

Program pin 6 as the On Couple pin; program pin 7 as the Off Couple pin. This setting is saved in non volatile memory.

Front Panel Menu Reference	SCPI Command
Select <b>System\IO\DigPort\Pins</b>	To set pin 6 as the On Couple:
Select pin 6, then Function, then On Couple.	<b>DIG:PIN6:FUNC ONC</b>
Select pin 7, then Function, then Off Couple.	To set pin 7 as the Off Couple:
	<b>DIG:PIN6:FUNC OFFC</b>

Enable the On Couple/Off Couple function. This setting is saved in non volatile memory.

Front Panel Menu Reference	SCPI Command
Select <b>Output\Sequence\Couple</b>	To enable output coupling:
Check Enable to enable output coupling.	<b>OUTP:COUP ON</b>

You do not need to specify a Turn-on delay, Turn-off delay, or Delay offset.

## Program the Output Voltage and Current

Refer to [Set the Output Voltage](#) and [Set the Output Current](#) for details.

### In voltage priority mode:

- Program the initial output voltage setting of each paralleled unit to the same value.
- Set the current limit of each paralleled unit according to the following equations. This will allow all units to share current until the total current limit point is reached, which is the sum total of all the individual current limits.

For each 1kW unit:  $I_{CL\_1kW} = I_{CL\_TOTAL} / (N_T + N_{2kW})^*$

For each 2kW unit:  $I_{CL\_2kW} = 2(I_{CL\_TOTAL}) / (N_T + N_{2kW})$

where:

$I_{CL\_1kW}$  is the current limit setting of the 1kW unit

$I_{CL\_2kW}$  is the current limit setting of the 2kW unit

$I_{CL\_TOTAL}$  is the sum total of all individual current limits

## 4 Using the Advanced Power System

$N_T$  is the total number of paralleled units of any rating

$N_{2kW}$  is the total number of paralleled 2 kW units

\*If there are no 2kW units used, then  $N_{2kW} = 0$ .

Note that in a mixed power configuration, you must set the current limit of the 2 kW units to twice the value of the 1 kW units. This is because in a mixed power configuration, each 2kW unit will contribute twice as much current as each 1kW unit.

When the current limit setting of any paralleled unit is reached, the output current of that unit will limit at its specified setting.

### In current priority mode:

- Set the voltage limit of each paralleled unit to the same value.
- Program the current setting of each paralleled unit according to the equations above if current sharing is desired. The total output current will be the sum of all the individual current settings.

Note that in current priority mode, the sharing configuration will balance the currents only if all of the units are operating in voltage limit mode, with the VL+ status annunciator on.

## Program a Step Function for Additional Output Changes

Refer to [Programming a Step Transient](#) for details. Connect the Trigger signal to the paralleled units as shown in the previous figure. Then enable the transient Step function.

Front Panel Menu Reference	SCPI Command
Select <b>Transient\Mode</b>	To enable Voltage transient mode: <b>VOLT:MODE STEP</b>
Select Voltage Mode or Current Mode. In the dropdown list select Step.	To enable Current transient mode: <b>CURR:MODE STEP</b>

In Voltage priority mode, the current transient must remain set to Fixed. In Current priority mode, the voltage transient must remain set to Fixed.

### NOTE

For **N7900 models** **N6900 Opt 303**, you can also program output changes using the List Transient and Arbitrary Waveform functions. Refer to [Programming a List Transient](#) and [Programming an Arbitrary Waveform](#) for details.

## Program the Step Values and Specify the Trigger Out Signal Source

### In voltage priority mode:

- Program the output voltage step of each paralleled unit to the same value.

### In current priority mode:

- Program the current step of each paralleled unit according to the previous equations. The total output current will be the sum of all the individual current settings.

Front Panel Menu Reference	SCPI Command
Select <b>Transient\Step</b>	In Voltage priority mode: <b>VOLT:TRIG &lt;value&gt;</b>
Select either the Trig Voltage or the Trig Current box and enter the step value.	In Current priority mode: <b>CURR:TRIG &lt;value&gt;</b>

Designate the "master" unit (Unit 1) as the source of the Step trigger signal.

Front Panel Menu Reference	SCPI Command
Select <b>Transient\Step</b>	Select the Step function as the trigger source: <b>STEP:TOUT ON</b>
Check Enable Trigger Output.	

## Program the Digital Trigger Pins

Configure pin 1 as the transient trigger source on all units.

Front Panel Menu Reference	SCPI Command
Select <b>Transient\TrigSource</b>	Select the transient trigger source: <b>TRIG:TRAN:SOUR PIN1</b>
Select Pin 1 from the dropdown list.	

Configure pin 1 as the trigger output for the "master"(Unit 1).

The master unit will provide the trigger signal to synchronize all units.

Front Panel Menu Reference	SCPI Command
Select <b>System\IO\DigPort\Pins</b>	Select the trigger output function: <b>DIG:PIN1:FUNC TOUT</b>
Select Pin 1, then select the Trig Out function. Keep the polarity set to Positive.	Select the pin polarity: <b>DIG:PIN1:POL POS</b>

Configure pin 1 as the trigger input for the remaining paralleled units (Unit 2, 3, etc.)

These units will receive the trigger signal from the master unit.

Front Panel Menu Reference	SCPI Command
Select <b>System\IO\DigPort\Pins</b>	Select the trigger input function: <b>DIG:PIN1:FUNC TINP</b>
Select Pin 1, then select the Trig In function. Keep the polarity set to Positive.	Select the pin polarity: <b>DIG:PIN1:POL POS</b>

## Enable the Output and Trigger Additional Output Changes

Enable the outputs. All outputs will be set to the initial voltage and current values.

## 4 Using the Advanced Power System

Front Panel Menu Reference	SCPI Command
Push the <b>Output</b> key on the “master” (Unit 1)	On the “master” (Unit 1): <b>OUTP ON</b>

Initiate the transient systems on all units.

Front Panel Menu Reference	SCPI Command
Select <b>Transient\Control</b> Select <b>Initiate</b> .	Initiate the transient trigger system: <b>INIT:TRAN</b>

Trigger additional output changes. All units will be set to the step values. On the “master” (Unit 1) only:

Front Panel Menu Reference	SCPI Command
Select <b>Transient\Control</b> Select <b>Trigger</b> .	To trigger the Step transient: <b>TRIG:TRAN</b>

### Specification Effects

The design of the APS has been optimized for parallel operation. Therefore, the effect of paralleled units on the specifications has been kept to a minimum.

When units are paralleled, there is no degradation of any specification other than the load regulation specification. All other specifications, including output noise, programming accuracy, readback accuracy, and transient response are unaffected by paralleled operation. For example, the transient response specification for a paralleled combination is the same as the transient response for an individual unit.

#### Load Regulation Effect

With two or more units are paralleled with current sharing enabled, there will be a small additional voltage regulation effect. The worst case additional voltage regulation effect is as follows:

$$\Delta V_{OUT(WORST\_CASE)} = 0.003\% (V_{RATING})$$

To determine the total output voltage regulation effect for a specific unit, you must add the worst-case value from the following table to the **CV load regulation specification** for each paralleled unit.

These are the worst-case values for each unit based on its voltage rating.

V <sub>RATED</sub>	ΔV <sub>OUT(WORST_CASE)</sub>	V <sub>RATED</sub>	ΔV <sub>OUT(WORST_CASE)</sub>
9 V	0.27 mV	80 V	2.40 mV
20 V	0.60 mV	120 V	3.60 mV
40 V	1.20 mV	160 V	4.80 mV
60 V	1.80 mV		

**Example:** You have two 80 V units connected in parallel. The load regulation effect due to current sharing is 2.4 mV from the table above. The CV load regulation specification is 2 mV. Therefore, the total output voltage regulation effect is 2 mV + 2.4 mV, or 4.4 mV.

## Current Sharing Effects

This section describes the current sharing effects of the paralleled units. These only affect the operation of the paralleled units when operating near the current limit setting in voltage priority mode, operating near the voltage limit setting in current priority mode, or when using the low current measurement range.

In an ideal current sharing configuration, the total load current would be shared equally among all paralleled power supplies. For example, if you have three 1kW units connected in parallel and the load draws 75 A, each 1kW unit would contribute *exactly* 25 A to the total load current requirement.

However, due to internal offset and gain differences among the paralleled units, there will be slight differences in the current being shared by the individual units. Normally this does not affect the operation of the units or the total current being drawn by the load in any way. However, because of these slight sharing differences, the output current of an individual unit may bump up against the current limit setting before the other units do. This will result in a current sharing fault (CSF), which means that one of the units is no longer sharing current equally. The units will continue to source current until the current limit setting of all units is reached. If the load current attempts to increase above the sum of the individual current limits, the paralleled units will be in constant current mode, with the output current being regulated rather than the output voltage.

Another way that current sharing deviation can affect operation is when using the low current measurement range on N7900 models. Current sharing deviations are greater as a percentage of output current when operating at low current levels than when operating at high current levels. Thus, when operating at less than 10 % of the output current rating, the current sharing offset errors between paralleled units may be large enough to cause an unexpected "Out of Range" measurement error on the low current range. It is therefore recommended to leave the measurement range setting on Auto.

Note that when current sharing, the algebraic sum of the contributed currents of the paralleled units will always equal the total current drawn by the load. To determine the total load current, you must sum the output current readings of the individual paralleled units.

If you need to determine what the worst case current deviation among paralleled units is, refer to the [Current Sharing Tutorial](#).

## Current Sinking Operation

### Power Dissipator Operation

#### Querying the Power Dissipator

### Current Sinking

Current sinking, also referred to as down-programming, is the ability to pull current into the positive terminal of the DC power supply. For example, the power supply pulls or sinks current into the positive terminal whenever a lower output voltage is programmed. This is necessary because stored energy from the power supply's output capacitor and external capacitance from the load including the wiring must be discharged to lower the voltage at the output terminals.

The ability to rapidly transition from a higher to a lower constant voltage level greatly improves the power supply's output response time. This is the most commonly used function of the built in down-programmer, which is automatic and completely transparent to the user.

When operated as a stand-alone unit, the DC power supply can continuously sink up to 10% of its rated current for an indefinite time. This is adequate for rapidly down-programming the majority of loads connected to the output.

With the addition of Keysight N7909A Power Dissipator Units, the DC power supply can sink up to 100% of its rated current. This allows for the possibility of sinking the power supply's full rated output current for an indefinite time. This capability is useful with large capacitive loads, or with battery charging/discharging applications.

Note that this **two-quadrant** sourcing and sinking capability of the DC power supply allows for seamless transitions between sourcing and sinking current without changing the power supply's output characteristics or introducing any disruptive behavior. The following controls are provided to fully utilize the two-quadrant output capability of the supply.

#### Current Limit control in voltage priority mode

When operating in voltage priority mode, you can program a negative or positive **current limit**. This will limit any current overshoots that may occur during rapid down-programming or up-programming.

#### Current setting control in current priority mode

When operating in current priority mode, you can program the output current to seamlessly cross the zero point when transitioning from positive to negative or negative to positive. Additionally, when operating in the negative current quadrant, you can program a negative **current setting** that will hold the sink current at the specified value. This is useful, for example, for discharging a battery at a constant current rate.

If your application requires precise control of the source and sink currents, current **slew controls** are available to specify a current slew rate when sourcing and sinking current.

## Power Dissipator Operation

Power supply models rated at 1 kW, require one Keysight N7909A power dissipator to sink 100% of their rated current. Power supply models rated at 2 kW, require two Keysight N7909A power dissipators to sink 100% of their rated current. 2 kW models connected to one power dissipator can sink 50% of their rated output current. Refer to [Connections–Power Dissipator](#) for installation information.

- Each N7909A unit has a total power dissipating capacity of 1 kW.
- Current sinking requires a minimum operating voltage as shown in the [output quadrant](#) characteristic.
- The N7909A does not have an On/Off switch. It turns on and off with the power supply. An LED on the unit will indicate that the unit is connected and operational. See [Power Dissipator at a Glance](#) for information about the front panel LEDs. The power dissipator must be connected **before** the power supply is tuned on, or it will not be recognized and does nothing. If the power dissipator is connected but not working, the power supply indicates a self-test error.
- The only operating difference for the power supply when the power dissipator is connected is that the sink current capability is increased from 10% to 100% of the rated current, and the negative power protection limit (CP-) is also increased.
- If the N7909A is disconnected during operation, the power supply indicates that a self-test error has occurred and reduces the sink current capability to 10% of the rated current. The negative power protection limit (CP-) is also reduced, which may cause the unit to go into a CP- protection mode.
- The cables connecting the N7909A to the power supply cannot be longer than 1 meter. This limits the distance that the N7909A can be located away from the power supply.
- The temperature sensor information from the power dissipator is combined with the temperature sensor information from the power supply. The minimum difference between the internal temperature sensors and the over-temperature trip level is reported by the [OUTPut:PROTEction:TEMPerature:MARGin?](#) query.

## Querying the Power Dissipator

Other than looking at the front panel LED of the power dissipator, the only way to know if the unit is connected and operating correctly is to query the negative current limit of the power supply.

Front Panel Menu Reference	SCPI Command
Not available	To query the negative current limit: <b>CURR:LIM:NEG? MIN</b>
	Note that the MIN parameter returns the most-negative current value.

#### 4 Using the Advanced Power System

If the negative current limit query returns a value that equals 10% of the rated current of the power supply, the power dissipator is not recognized by the power supply. Turn the power supply off, make sure that the power dissipator is properly connected, and turn the power supply on again.

For 1 kW models, if the negative current limit query returns a value that equals 100% of the rated current of the power supply, the power dissipator is connected and recognized.

For 2 kW models, if the negative current limit query returns a value that equals 100% of rated current of the power supply, both power dissipators are connected and recognized. If the value equals 50% of the rated current, only one power dissipator is connected and recognized.

## System-Related Operations

Though not directly related to output programming, the following functions also control instrument operation.

### Instrument Identification

### Instrument State Storage

### Front Panel Display

### Front Panel Lock-Out

### Password Protection

## Instrument Identification

You can query the model number, serial number, options, and firmware revision. SCPI commands return information with the \*IDN? and \*OPT? queries.

Front Panel Menu Reference	SCPI Command
Select <b>System&gt;About\Frame</b> .	To return manufacturer, model number, serial number, and firmware revision: <b>*IDN?</b>
	To return the installed options: <b>*OPT?</b>

## Instrument State Storage

The power supply has ten storage locations in non-volatile memory to store instrument states. The locations are numbered 0 through 9. Any state previously stored in the same location will be overwritten.

Front Panel Menu Reference	SCPI Command
Select <b>States\SaveRecall</b> .	To save a state in location 1: <b>*SAV 1</b>
In the SaveRecall field, enter a location from 0 to 9. Then press <b>Select</b> .	To recall a state from location 1: <b>*RCL 1</b>
Select <b>Save</b> to save the state to <b>Recall</b> to recall a state.	

### Specifying a power-on state

When shipped, the power supply is configured to automatically recall the reset (\*RST) settings at power-on. However, you can configure the power supply to use the settings you have stored in memory location 0 at power-on.

Front Panel Menu Reference	SCPI Command
Select <b>States\PowerOn</b> .	<b>OUTP:PON:STAT RCL0</b>
Select <b>Recall State 0</b> . Then press <b>Select</b> .	

## Front Panel Display

The power supply has a front panel screen saver that significantly increases the life of the LCD display by turning it off during periods of inactivity. The delay can be set from 30 to 999 minutes in 1 minute increments. As shipped, the screen saver comes on one hour after activity on the front panel or interface has ceased.

When the screen saver is active, the front panel display turns off, and the LED next to the Line switch changes from green to amber. To restore the front panel display, simply press one of the front panel keys. The first action of the key turns the display on. Subsequently, the key will revert to its normal function.

If the Wake on I/O function is selected, the display is restored whenever there is activity on the remote interface. This also resets the timer on the screen saver. As shipped, Wake on I/O is active.

Front Panel Menu Reference	SCPI Command
Select <b>System\Preferences\Display\Saver</b>	To turn the front panel screen saver on or off:
Enable or disable the screen saver by checking or unchecking the Screen Saver checkbox. Then press <b>Select</b> .	<b>DISP:SAV ON OFF</b>
Enter a value in minutes in the Saver Delay field to specify the time when the screen saver will activate.	
Check Wake on I/O to activate the display with I/O bus activity.	

### Specifying the power-on view

Note that you can specify which measurement functions are displayed at turn-on.

Front Panel Menu Reference	SCPI Command
Select <b>System\Preferences\Display\View</b> .	To select a turn-on meter view:
From the dropdown menu select: Voltage,Current; Voltage,Power; or Volt,Curr,Power. Then press <b>Select</b> .	<b>DISP:VIEW METER_VI</b> <b>DISP:VIEW METER_VP</b> <b>DISP:VIEW METER_VIP</b>

## Front Panel Lock-Out

You can lock the front panel keys to prevent unwanted control of the instrument from the front panel. This is the most secure way of locking the front panel keys because you need a password to unlock the front panel. This parameter is saved in non-volatile memory. Therefore, the front panel remains locked even after AC power is cycled.

Front Panel Menu Reference	SCPI Command
Select <b>System\Preferences\Lock</b>	Not available
In the dialog box, enter the password to unlock the front panel. Then select Lock.	
The menu to unlock the front panel appears every time a key is pressed. Enter the password to unlock the front panel.	

If the password is lost, the **SYSTem:PASSword:FPANel:RESet** command can reset the front panel lockout password. Refer to **Calibration Switches** for more information.

The **SYSTem:COMMunicate:RLState RWLock** command can also lock and unlock the front panel. This command is completely independent of the front panel lockout function. If you use this command to lock the front panel, the front panel will be unlocked when AC power is cycled.

## Password Protection

You can password-protect all functions located in the Admin menu. These include: instrument calibration, interface access, non-volatile memory reset, firmware update, password updates.

As shipped, the Admin menu password is 0 (zero). This means that you do not have to enter a password to access the Admin menu. Simply select **System\Admin>Login** and press Enter. To password-protect the Admin menu:

Front Panel Menu Reference	SCPI Command
Select <b>System\Admin&gt;Password</b>	Enter calibration mode using the original password <b>CAL:STAT ON, &lt;password&gt;</b>
The password must be numeric, and up to 15 digits long.	
Press Select	To change the password: <b>CAL:PASS &lt;password&gt;</b>
Log out of the Admin menu to activate the password. You can now only enter the Admin menu by providing the right password. Enter the password in the Password field.	To exit calibration mode and activate the password: <b>CAL:STAT OFF</b>

If the password is lost, access can be restored by setting an internal switch to reset the password to 0. If the message “Locked out by internal switch setting” or “Calibration is inhibited by switch setting” appears, the internal switch is set to prevent the password from being changed. Refer to **Calibration Switches** for more information.

## Priority Mode Tutorial

### Voltage Priority

In voltage priority mode the output is controlled by a constant-voltage feedback loop, which maintains the output voltage at its programmed setting as long as the load current remains within the positive or negative current limit settings. Voltage priority mode is best suited for use with resistive or high impedance loads, and loads that are sensitive to voltage overshoots. Do not use voltage priority mode with low-impedance sources such as batteries, power supplies, or large charged capacitors.

In voltage priority mode, the output voltage should be programmed to the desired value. A positive and negative current limit value should also be set. The current limit should always be set to a value that is greater than the actual output current requirement of the external load. The following figure shows the voltage priority operating locus of the output. The area in the white quadrants shows the output as a source (sourcing power). The area in the shaded quadrants shows the output as a load (sinking power).

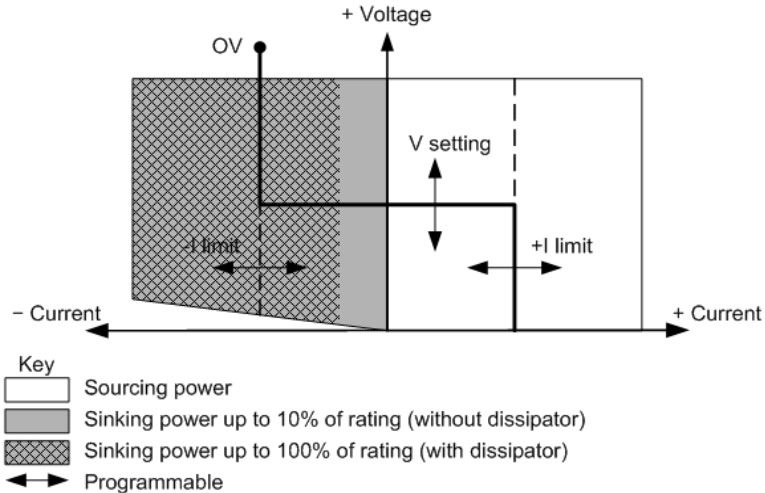

The heavy solid line illustrates the locus of possible operating points as a function of the output load. As shown by the horizontal portion of the line, the output voltage remains regulated at its programmed setting as long as the load current remains within the positive or negative current limit setting. A CV (constant voltage) status flag indicates that the output voltage is being regulated and the output current is within its limit settings.

When the output current reaches either the positive or negative current limit, the unit no longer operates in constant voltage mode and the output voltage is no longer held constant. Instead, the power supply will now regulate the output current at its current limit setting. Either a LIM+ (positive current limit), or LIM- (negative current limit) status flag is set to indicate that a current limit has been reached. These conditions are annunciated by CL+ or CL- on the front panel.

As shown by the vertical portions of the load line, the output voltage may continue to increase in the positive direction or decrease in the negative direction as current is forced into or pulled out of the unit. When the output voltage exceeds the over-voltage protection setting, the output will shut down, the output relays will open, and the OV status bit will be set.

## Current Priority

In current priority mode the output is controlled by a bi-polar constant current feedback loop, which maintains the output source or sink current at its programmed setting. The output current will remain at its programmed setting as long as the load voltage remains within the voltage limit setting. Current priority mode is best suited for use with batteries, power supplies, large charged capacitors, and loads that are sensitive to current overshoots. It minimizes current overshoots during programming, turn-on, and turn-off transitions and seamlessly transitions between positive and negative currents.

In current priority mode, the output current should be programmed to the desired positive or negative value. A positive voltage limit value should also be set. The voltage limit should always be set to a value that is greater than the actual output voltage requirement of the external load. The following figure shows the current priority operating locus of the output. The area in the white quadrants shows the output as a source (sourcing power). The area in the shaded quadrants shows the output as a load (sinking power).

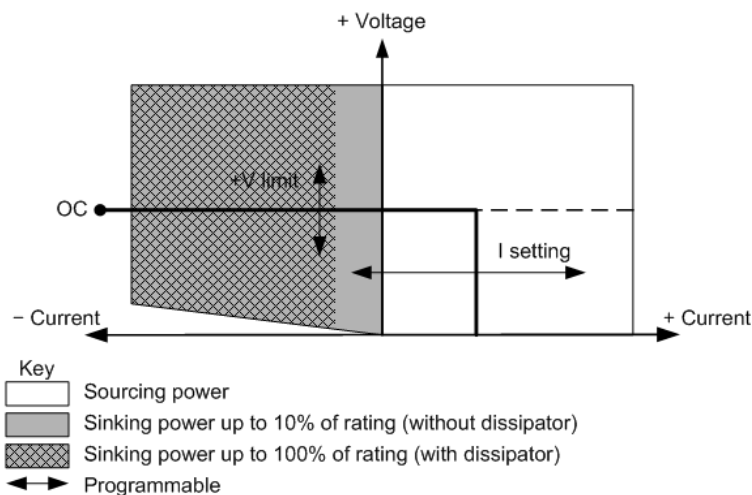

The heavy solid line illustrates the locus of possible operating points as a function of the output load. As shown by the vertical portion of the line, the output current remains regulated at its programmed setting as long as the output voltage remains within its limit setting. A CC (constant current) status flag indicates that the output current is being regulated and the output voltage is within its limit settings.

If the output voltage reaches the voltage limit, the unit no longer operates in constant current mode and the output current is no longer held constant. Instead, the power supply will now regulate the output voltage at its voltage limit setting. A LIM+ (positive voltage limit) status flag is set to indicate that the voltage limit has been reached. This condition is annunciated by VL+ on the front panel.

As shown by the horizontal portion of the load line, when the unit is sinking power, the output current may continue to increase in the negative direction as more current is forced into the unit. This can happen when the load is a power source such as a battery, and its output voltage is higher than the voltage limit setting of the power supply. Once the current exceeds the built-in negative over-current limit, the output will shut down, the output relays will open, and the OC status bits will be set. In such a case, it is important to set the voltage limit properly in order prevent this protection shutdown.

## Current Sharing Tutorial

### Current Sharing Calculations

#### Sharing Deviation for Units of Equal Power (either 1 kW or 2 kW)

#### Sharing Deviation for Units of Mixed Power (1 kW paralleled with 2 kW)

This section describes how to calculate the current sharing effects of paralleled units of equal and mixed power. These only affect the operation of the paralleled units when operating near the current limit setting in voltage priority mode, operating near the voltage limit setting in current priority mode, or when using the low current measurement range. For a description of the current sharing operation, refer to [Current Sharing](#).

### Current Sharing Calculations

In an ideal current sharing configuration, the total load current would be shared equally among all paralleled power supplies.

$$I_{OUT(1kW\_IDEAL)} = I_{LOAD\_TOTAL} / (N_T + N_{2kW})$$

$$I_{OUT(2kW\_IDEAL)} = 2(I_{LOAD\_TOTAL}) / (N_T + N_{2kW})$$

where:

$I_{LOAD\_TOTAL}$  is the total load current

$N_T$  is the total number of paralleled units of any rating

$N_{2kW}$  is the total number of paralleled 2 kW units

The difference between the ideal output current and the actual output current for a single contributing paralleled unit can be expressed in the form of a gain error, G and offset error, K as shown.

$$\Delta I_{OUT(WORST\_CASE)} = \pm G(I_{OUT(IDEAL)}) \pm K(I_{RATING})$$

where:

G is the gain error

K is the offset error

In a 1 kW configuration, the  $I_{RATING}$  is the rated current for the 1 kW unit

In a 2 kW configuration, the  $I_{RATING}$  is the rated current for the 2 kW unit

In a mixed power configuration, the  $I_{RATING}$  is the rated current for the 2 kW unit

The following sections describe how to calculate the worst-case deviation from the ideal current for each contributing paralleled unit.

### Sharing Deviation for Units of Equal Power (either 1 kW or 2 kW)

The following table gives the Gain and Offset values for paralleled units of equal power:

Paralleled Units ( $N_T$ )	Gain Error % (G)	Offset Error % (K)	Gain and Offset Equations
2	0.200	0.6	$G = 0.4\%((N_T - 1)/N_T)$
3	0.267	1.2	$K = 0.6\%(N_T - 1)$
4	0.300	1.8	
5	0.320	2.4	

**Example (60 A load current)** You have three 1 kW, 40 V, 25 A units connected in parallel drawing a total load current of 60 A. Using the gain and offset values from the above table ( $G=0.267\%$ ;  $K=1.2\%$ ), the worst-case deviation from the ideal current sharing contribution of 20 A for an individual unit would be as follows:

$$\Delta I_{OUT(WORST\_CASE)} = \pm G(I_{OUT(IDEAL)}) \pm K(I_{RATING})$$

$$\Delta I_{OUT(WORST\_CASE)} = \pm 0.267\%(20A) \pm 1.2\%(25A)$$

$$\Delta I_{OUT(WORST\_CASE)} = \pm 0.353A$$

Note that the percent of deviation from the ideal becomes greater for smaller output currents, because the offset error predominates. This holds true all the way down to zero current. If, in the above example, the paralleled units were drawing no current (0 A), the worst case deviation would still be:

$$\Delta I_{OUT(WORST\_CASE)} = \pm 0.267\%(0A) \pm 1.2\%(25A)$$

$$\Delta I_{OUT(WORST\_CASE)} = \pm 0.3A$$

### Sharing Deviation for Units of Mixed Power (1 kW paralleled with 2 kW)

Note that calculating the current deviation in this procedure is a little more complicated than the previous one, because the 1 kW and the 2 kW units each contribute a *different* amount of current toward the total load current. Ideally, the 2 kW units contribute twice as much current as the participating 1 kW units.

The following table gives the Gain and Offset values for up to five paralleled units of mixed power:

Paralleled Units ( $N_T$ )	Gain Error % (G)	Offset Error % (K)	Gain and Offset Equations
2	0.267	0.40	$G = 0.8\%((N_T - 1)/(1 + 2(N_T - 1)))$
3	0.320	1.08	$K = 1.2\%(N_T((N_T - 1.5)/(2N_T - 1)))$
4	0.343	1.71	
5	0.356	2.33	

#### 4 Using the Advanced Power System

**Example (300 A load current)** You have three 9V units connected in parallel. Two of the units are 1kW units with a rated current of 100A. The other is a 2kW unit with a rated current of 200A. The load draws 300A of current.

You must first calculate the ideal output current contribution for the 1 kW and the 2 kW units. The ideal current contribution for the 1 kW unit is calculated as follows:

$$I_{OUT(1KW\_IDEAL)} = I_{LOAD\_TOTAL} / (N_T + N_{2kW})$$

$$I_{OUT(1KW\_IDEAL)} = 300A / (3+1)$$

$$I_{OUT(1KW\_IDEAL)} = 75A$$

The ideal current contribution for a 2 kW unit is calculated as follows:

$$I_{OUT(2KW\_IDEAL)} = 2(I_{LOAD\_TOTAL}) / (N_T + N_{2kW})$$

$$I_{OUT(2KW\_IDEAL)} = 2(300A) / (3+1)$$

$$I_{OUT(2KW\_IDEAL)} = 150A$$

where  $N_T = 3$ ,  $N_{1KW} = 2$ , and  $N_{2kW} = 1$

Note that the total ideal current equals the total load current:  $2(75A) + 150A = 300A$

You can now use the gain and offset values for three paralleled units of mixed power ( $G=0.320\%$ ;  $K=1.08\%$ ) to determine the worst-case deviation from the ideal current for each 1 kW unit. Note that for a mixed power configuration, the equations use  $I_{2kW\_RATING}$  for both the 1kW and the 2kW calculations.

$$\Delta I_{OUT(1KW\_WORST\_CASE)} = \pm G(I_{OUT(1KW\_IDEAL)}) \pm K(I_{2kW\_RATING})$$

$$\Delta I_{OUT(1KW\_WORST\_CASE)} = \pm 0.32\%(75A) \pm 1.08\%(200A)$$

$$\Delta I_{OUT(1KW\_WORST\_CASE)} = \pm 2.4A$$

Repeat the above step for the 2 kW unit.

$$\Delta I_{OUT(2KW\_WORST\_CASE)} = \pm G(I_{OUT(2KW\_IDEAL)}) \pm K(I_{2kW\_RATING})$$

$$\Delta I_{OUT(2KW\_WORST\_CASE)} = \pm 0.32\%(150A) \pm 1.08\%(200A)$$

$$\Delta I_{OUT(2KW\_WORST\_CASE)} = \pm 2.64A$$

# 5

## Using the Power Assistant Software

**Introduction**

**Using the Meter View**

**Black Box Data Recording**

**Configuring Signal Routing**

## Introduction

This section explains how to use the Keysight N7906A Power Assistant software.

### Requirements:

- Keysight N6900/N7900 Series Advanced Power System
- Keysight IO Libraries Suite 2021 (version 18.2)
- Microsoft .NET Framework 4 (standalone installer)
- Adobe Reader - for viewing the documentation

### Installing and Running the Software

**NOTE**

The Keysight Connection Expert does not have to be running for you to use the Power Assistant software, but it must be installed on your computer. However, before you run the Power Assistant for the first time, you must use the Keysight Connection Expert to connect to establish a connection to your instrument.

The Power Assistant software is available on the Keysight web at [www.keysight.com/find/N7906A](http://www.keysight.com/find/N7906A). To install and run the software:

1. Download the file KeysightPowerAssistant\_2021\_Setup.exe and run it on your computer. This will install the Power Assistant software.
2. Connect your instrument to your computer and run the Keysight Connection Expert. Make sure that a connection to your instrument is established.
3. Select the **Keysight N7906** icon to run the Power Assistant software application.

## Using the Meter View

The Meter tab displays the front panel of the instrument that you are connected to. You can control the instrument from this window much the same way that you use the actual front panel of the instrument. Select one of the other tabs (Black Box or Trigger) to access the remaining applications.

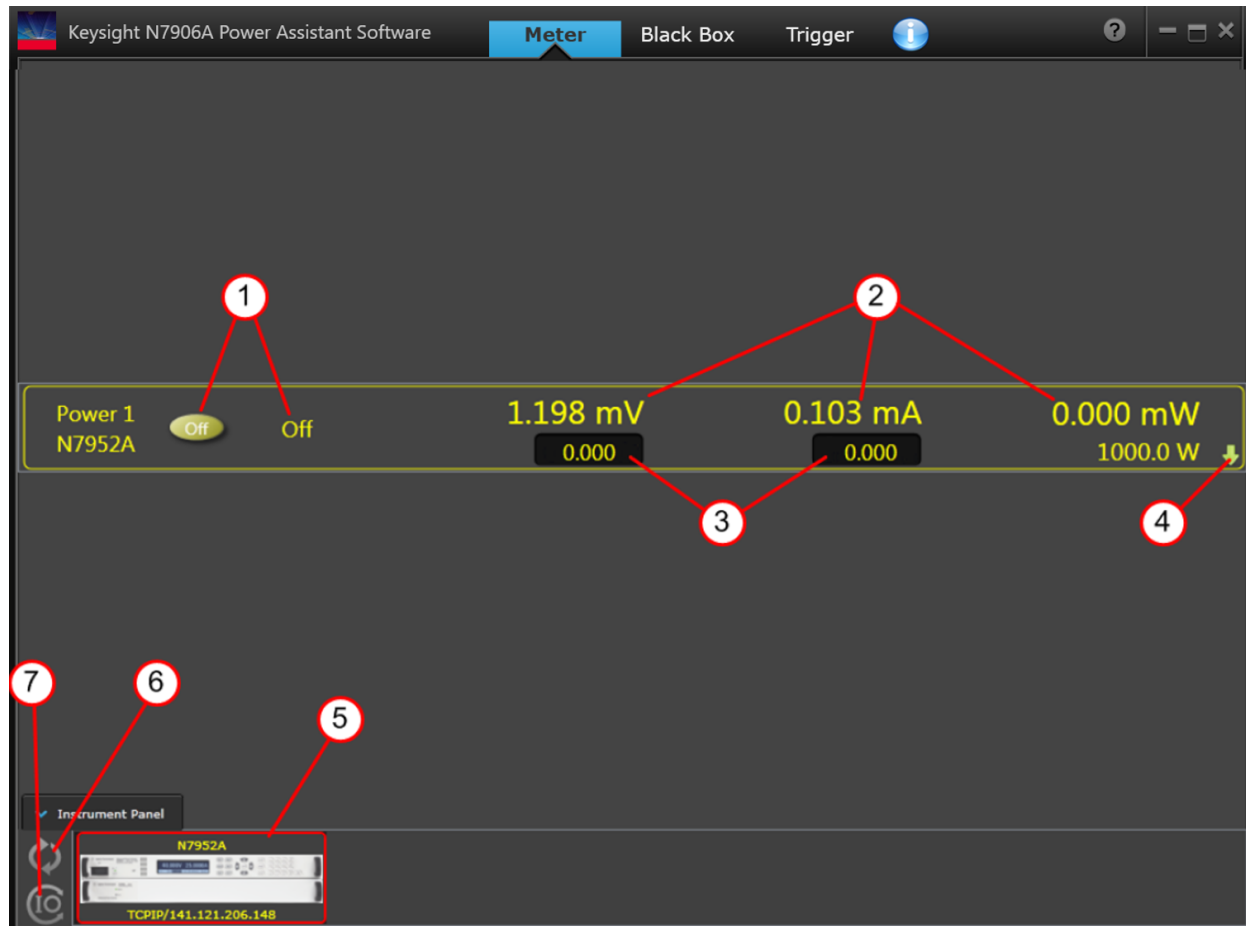

Note the following controls:

1. Turns the output on or off
2. Displays the measured output values
3. Displays the output settings
4. Expands the front panel controls (see below)
5. Displays the instrument that is being controlled
6. Click to refresh the instrument list
7. Click to launch the Keysight Connection Expert

## 5 Using the Power Assistant Software

When you expand the front panel controls, the following additional controls appear. These access the same controls that are available from the actual front panel of the instrument.



## Configuring Signal Routing

This section explains how to use the Power Assistant to configure signal routing.

### Routing Signals

#### Downloading the Routing

#### Saving the Routing File

#### Viewing the SCPI Commands

#### Source Icon Descriptions

#### Operator Icon Descriptions

#### Target Icon Descriptions

#### Signal Routing Examples

## Routing Signals

Select the **Trigger** tab on top of the Power Assistant window. To get started configuring signal routing:

1. Select a signal source from the Source list on the left panel. For example click the Status icon to place it onto the work area. Select CL+ from the Status dropdown list.
2. Select a signal target from the Target list on the right panel. For example click the Digital icon to place it onto the work area. Select Pin 1 and Positive polarity from the Digital dropdown list.
3. Move the Status and Digital icons together until a dotted yellow line appears. Continue moving the icons until the dotted line becomes solid.

As shown below, you have now routed the CL+ status signal to Pin 1 on the digital connector. Any time a CL+ (positive current limit) occurs, the signal is routed to digital connector pin 1.

## 5 Using the Power Assistant Software

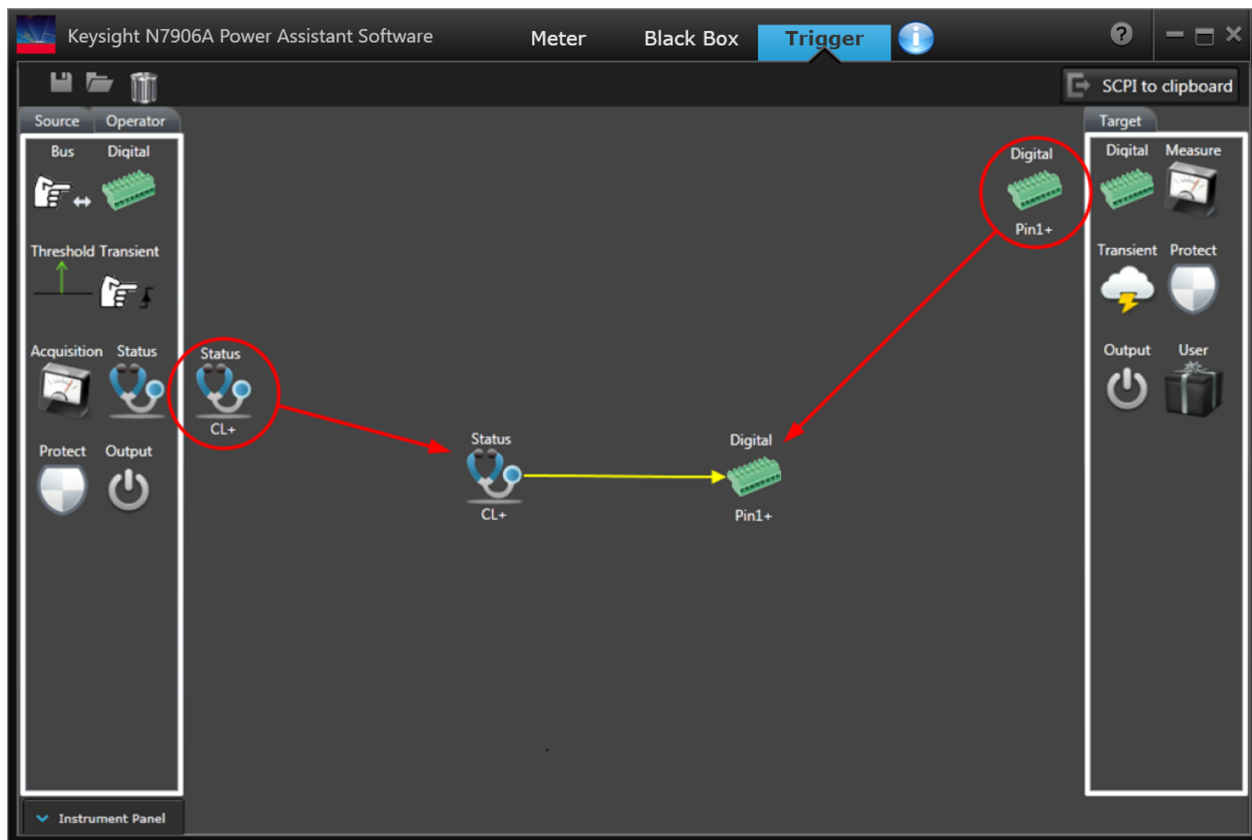

### Downloading the Routing

When you have completed the signal routing, you must download it to the instrument.

- Click **Instrument Panel** if the instrument to which you are connected, does not appear in the window.
- Click on the instrument to select it. Click the green down arrow to download the routing to the instrument (see below).
- If you have a routing already downloaded that you wish to edit, click the green up arrow to upload the routing to the Power Assistant.

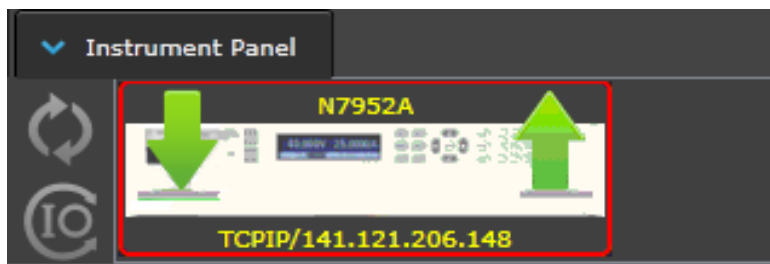

## Saving the Routing File

You can save and retrieve routing files on your computer.

- Click the **Disc** icon on top of the window to save the file. The default file location is C:\Program Files\Keysight\PowerAssistant. Rename the file, as the default filename is overwritten each time a new file is saved.
- Click the **Folder** icon to open any saved files with the Power Assistant.



## Viewing the SCPI Commands

If you wish to view the source code for the expression you have created, select **SCPI to Clipboard** to copy the equivalent SCPI commands to your computer's clip board.

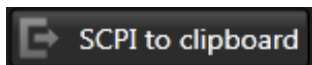





Then paste the file into Notepad or any other text editor.





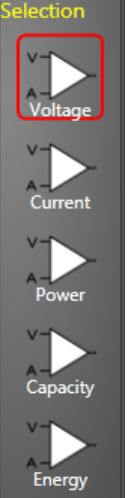
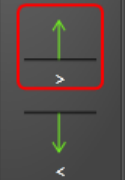

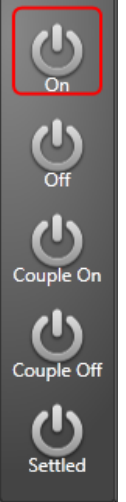

The following figure shows the equivalent SCPI commands from the above example copied to Notepad.

 A screenshot of a Notepad window titled "Untitled - Notepad". The window has a menu bar with "File", "Edit", "Format", "View", and "Help". The text area contains three lines of SCPI commands:
 





```
:SYSTem:SIGNal:DEFine EXPResion1,"CL+"
:DIGital:PIN1:FUNCTion EXPResion1
:DIGital:PIN1:POLarity POSitive
```

### Source Icon Descriptions



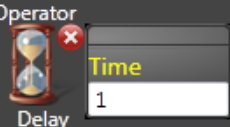

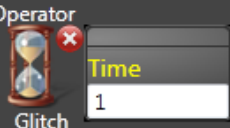

<p><b>Status Icons</b></p> <p><b>Selection</b></p> 	<p><b>When the signal is true</b></p> <p>The output is regulating in constant voltage mode</p> <p>The output is in positive current limit</p> <p>The output is in negative current limit</p> <p>The output is regulating in constant current mode</p> <p>The output is in positive voltage limit</p> <p>The remote sense connections are open</p>	<p><b>Threshold Icons</b></p> <p><b>Selection</b></p>  <p><b>Direction</b></p>  <p><b>Level</b></p> <input type="text" value="1"/>	<p><b>Level comparators generate a true signal based on the comparison of two inputs</b></p> <p>The measured voltage level comparison</p> <p>The measured current level comparison</p> <p>The measured power level comparison</p> <p>The measured amp-hour level comparison</p> <p>The measured watt-hour level comparison</p> <p>The measured level is greater than the specified level</p>
<p><b>Protection Icon</b></p> 	<p><b>When the signal is true</b></p> <p>The output is disabled by an active protection function</p>		<p>The measured level is less than the specified level</p> <p>The specified level</p>
<p><b>Output Icons</b></p> <p><b>Selection</b></p> 	<p><b>When the signal is true</b></p> <p>The output state is on</p> <p>The output state is off</p> <p>Pulses true when the output is starting to turn on</p> <p>Pulses true when the output is starting to turn off</p> <p>The output has reached the settled state</p>	<p><b>Digital Icons</b></p> <p><b>Selection</b></p>  <p><b>Polarity</b></p> 	<p><b>Digital output pins can generate a true signal</b></p> <p>A digital port pin (from 1 to 7)</p> <p>Specifies a positive transition of the signal</p> <p>Specifies a negative transition of the signal</p>

<p><b>Transient Icons</b></p> <p><b>Selection</b></p>  <p>Trigger Out</p>  <p>Waiting</p>  <p>Qualified</p>  <p>Active</p>	<p><b>When the signal is true</b></p> <p>Pulses true when a trigger out signal occurs (by a step or list)</p> <p>The instrument is waiting for the transient trigger</p> <p>Pulses true when the transient trigger occurs</p>	<p><b>Acquisition Icons</b></p> <p><b>Selection</b></p>  <p>Initiated</p>  <p>Waiting</p>  <p>Qualified</p>	<p><b>When the signal is true</b></p> <p>The acquisition is initiated or in progress</p> <p>The instrument is waiting for the acquisition trigger</p> <p>Pulses true when the acquisition trigger occurs</p>
	<p><b>Bus Icon</b></p>  <p>Bus</p>	<p>Pulses true when a bus trigger is received (either *TRG or GET)</p>	

**Operator Icon Descriptions**

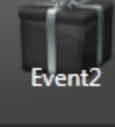
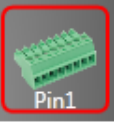
<p><b>Not Icon</b></p> <p>Operator</p>  <p>NOT</p>	<p>The input signal is not true</p>	<p><b>Delay Icon</b></p> <p>Operator</p>  <p>Delay</p>	<p>Delays the signal by the specified time</p>
<p><b>And Icon</b></p> <p>Operator</p>  <p>AND</p>	<p>The input signal is not true</p>	<p><b>Glitch Icon</b></p> <p>Operator</p>  <p>Glitch</p>	<p>Suppresses positive pulses narrower than the de-glitch time parameter</p>
<p><b>Or Icon</b></p> <p>Operator</p>  <p>OR</p>	<p>One of the input signals is true</p>		

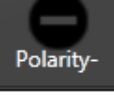
### Target Icon Descriptions

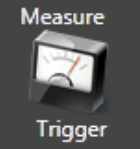
<p><b>Output Icons</b></p> <p>Selection</p>  <p>On</p>  <p>Off</p>	<p><b>When the signal is true</b></p> <p>Turns the output state on</p> <p>Turns the output state off</p>	<p><b>User Icons</b></p> <p>Selection</p>  <p>Event1</p>  <p>Event2</p>	<p><b>When the signal is true</b></p> <p>Selects the User1 status bit</p> <p>Selects the User2 status bit</p>
<p><b>Digital Icons</b></p> <p>Selection</p>  <p>Pin1</p> <p>•</p> <p>•</p> <p>•</p>  <p>Pin7</p> <p><b>Polarity</b></p>  <p>Polarity+</p>  <p>Polarity-</p>	<p><b>Digital output pins can generate a true signal</b></p> <p>A digital port pin (from 1 to 7)</p> <p>Specifies a positive transition of the signal</p> <p>Specifies a negative transition of the signal</p>	<p><b>Protection Icon</b></p>  <p>Protect</p> <p>User</p> <p><b>Transient Icon</b></p>  <p>Transient</p> <p>Trigger</p> <p><b>Measure Icon</b></p>  <p>Measure</p> <p>Trigger</p>	<p><b>When the signal is true</b></p> <p>Generates User-defined protection</p> <p><b>When the signal is true</b></p> <p>Generates a transient trigger (for a step, list, or Arb )</p> <p><b>When the signal is true</b></p> <p>Generates a measurement trigger</p>

### Signal Routing Examples

The following examples illustrate some simple signal routings.

**Example 1** Create a digital signal on pin1 of the digital port that is true whenever the output is in positive or negative current limit:

1. Select the Status icon from the Source list to place it onto the work area. Select CL- from the Status dropdown list.
2. Select another Status icon from the Source list to place it onto the work area. Select CL+ from the Status dropdown list.
3. Select the OR operator from the Operator list to place it onto the work area.

4. Move the CL- and CL+ icons toward the inputs of the Operator icon until the solid yellow connection lines appear.
5. Select the Digital icon from the Target list to place it onto the work area. Select Pin 1 and Positive polarity from the Digital dropdown list.
6. Move the Pin1 icon toward the output of the Operator icon until the solid yellow connection line appears.

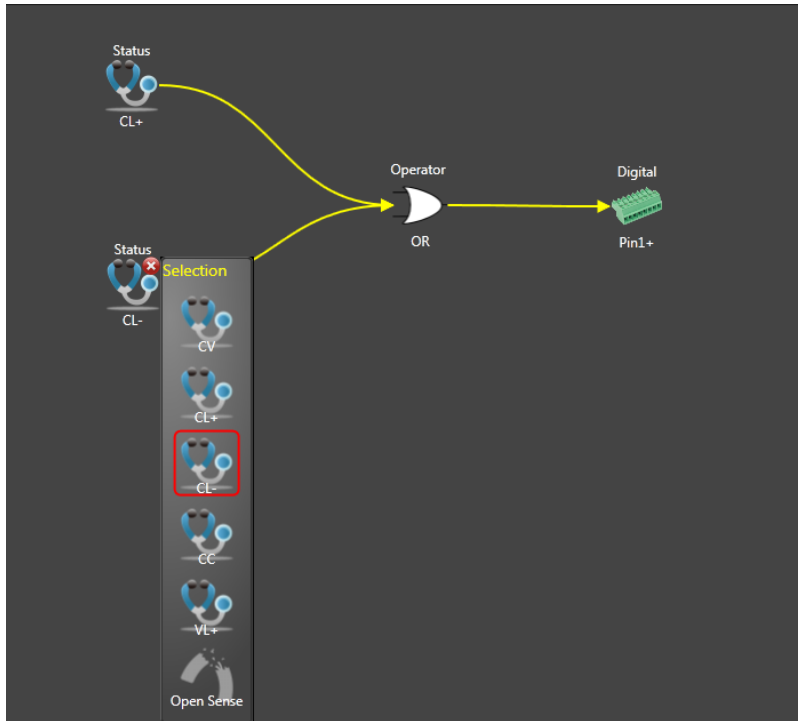

**Example 2** Create a trigger source that will trigger an output transient (step or list) whenever the output current is between 2.1 A and 2.7 A.

1. Select the Threshold icon from the Source list to place it onto the work area. Select Current, > direction, and enter a 2.1 level in the Level dropdown list.
2. Select another Threshold icon from the Source list to place it onto the work area. Select Current, < direction, and enter a 2.7 level in the Level dropdown list.
3. Select the AND operator from the Operator list to place it onto the work area.
4. Move the Threshold icons toward the inputs of the Operator icon until the solid yellow connection lines appear.
5. Select the Transient icon from the Target list to place it onto the work area. Select Trigger from the Transient dropdown list.
6. Move the Transient icon toward the output of the Operator icon until the solid yellow connection line appears.

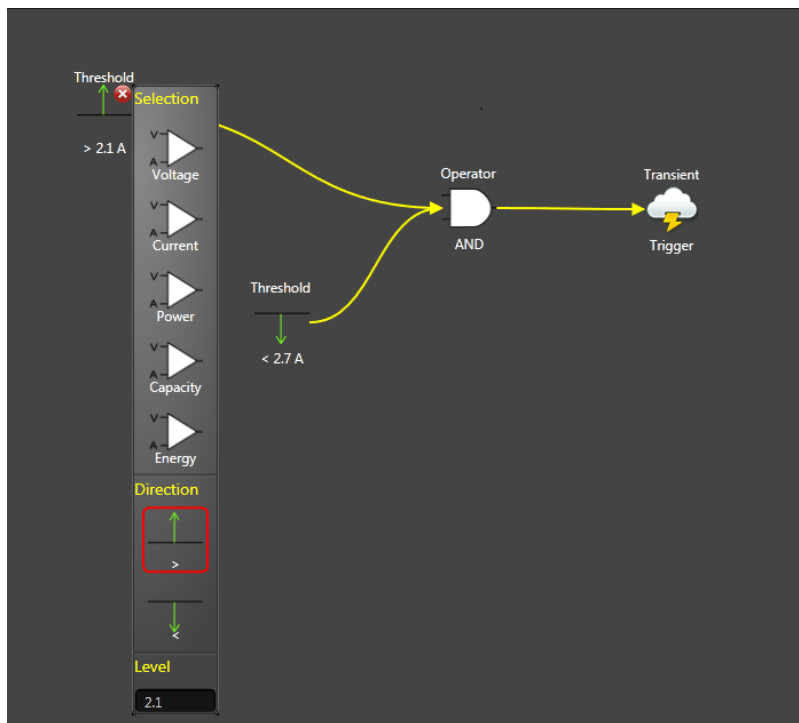

**Example 3** Create a custom protection that will disable the output if the output voltage moves outside the window between 23.5 V and 24.5 V.

1. Select the Threshold icon from the Source list to place it onto the work area. Select Voltage, > direction, and enter a 24.5 level in the Level dropdown list.
2. Select another Threshold icon from the Source list to place it onto the work area. Select Voltage, < direction, and enter a 23.5 level in the Level dropdown list.
3. Select the OR operator from the Operator list to place it onto the work area.
4. Move the Threshold icons toward the inputs of the Operator icon until the solid yellow connection lines appear.
5. Select the Protect icon from the Target list to place it onto the work area.
6. Move the Protect icon toward the output of the Operator icon until the solid yellow connection line appears.

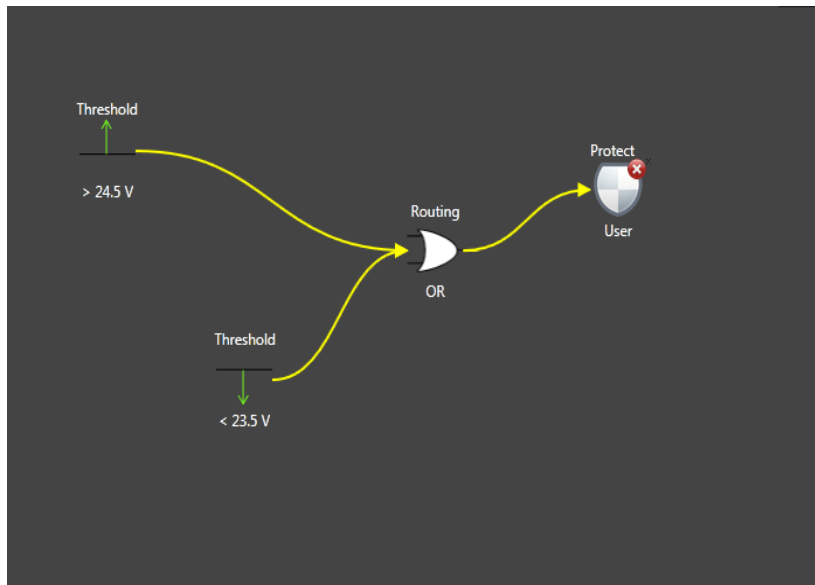

**Example 4** Create a trigger source that triggers a measurement 50 milliseconds after the output has settled.

1. Select the Output icon from the Source list to place it onto the work area. Select Settled from the Output dropdown list.
2. Select the Delay operator from the Operator list to place it onto the work area. Enter a 0.05 second delay time in the Time field of the dropdown list.
3. Move the Output icon toward the input of the Operator icon until the yellow connection line appears.
4. Select the Measure icon from the Target list to place it onto the work area.
5. Move the Measure icon toward the output of the Operator icon until the solid yellow connection line appears.

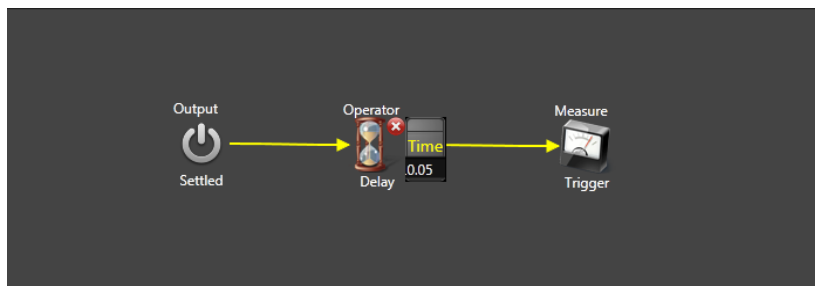

## Black Box Data Recording

This section explains how to use the Power Assistant to retrieve and view data from the Black Box Recorder.

### Making a Snapshot

### Retrieving the Snapshot

### Viewing the Snapshot

### Configuring the Display

### Viewing the Snapshot

### Exporting the Snapshot Data

### Saving the Snapshot File

## Making a Snapshot

**NOTE**

It is good practice to verify the system date and time before retrieving Black Box data. Refer to [BBR Clock Setup](#).

You can retrieve logged data by requesting a "snapshot" either from the front panel or using SCPI commands. Refer to [Snapshot Operation](#). The snapshot always uploads from the most recent data entry on back.

Once you have created the snapshot, you can retrieve and view the snapshot data with the Power Assistant.

## Retrieving the Snapshot

Select the **Black Box** tab on top of the Power Assistant window.

- Click **Instrument Panel** if the instrument to which you are connected, does not appear in the window.
- Click on the instrument to select it. Click the green up arrow to upload the snapshot to the instrument (see below). A progress bar lets you know that the file is uploading.
- Once the file has finished uploading, the data will appear in the display.

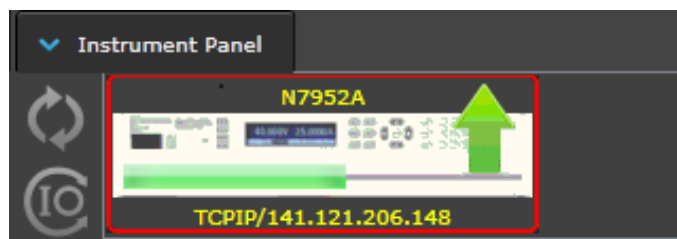

## Viewing the Snapshot

The Black Box tab displays the snapshot data file that you retrieved from the instrument. The snapshot always uploads from the most recent data entry on back. The following figure illustrates a sample snapshot file:

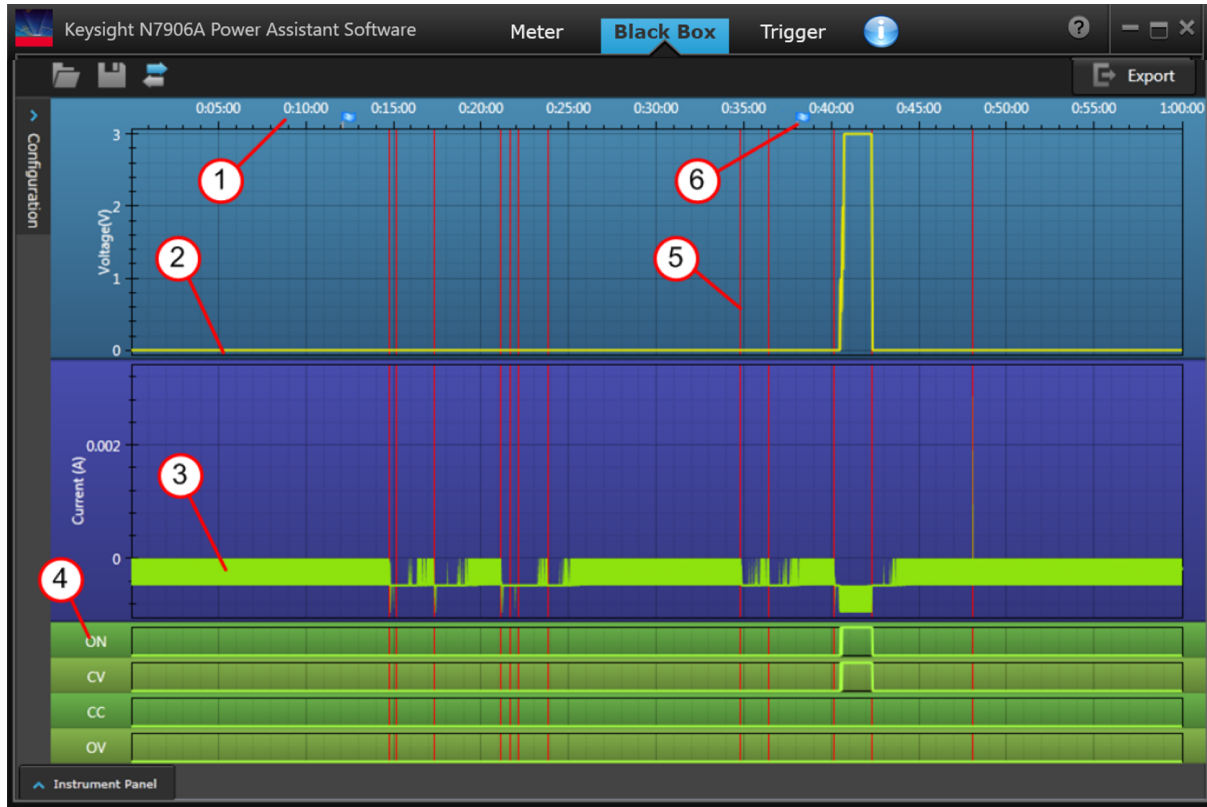

Note the following areas of interest:

1. The area on top of the display indicates the total time period of the snapshot
2. The yellow line is the output voltage.
3. The green line is the output current.
4. The green portion of the window displays the status states.
5. The vertical red lines indicate when power was cycled on or off.
6. The pale blue dots on the timeline indicate where a user-defined message was placed into the log (see Viewing Snapshot Events).

## Configuring the Display

Not all of the snapshot data can be displayed on the window at the same time. You can decide which data you wish to view.

## 5 Using the Power Assistant Software

- Click **Configuration** to configure the snapshot view.
- Click the items that you wish to appear on the display. Scroll down to view all of the items in the list. In the following example, six items are selected. This matches what is shown in the previous figure.

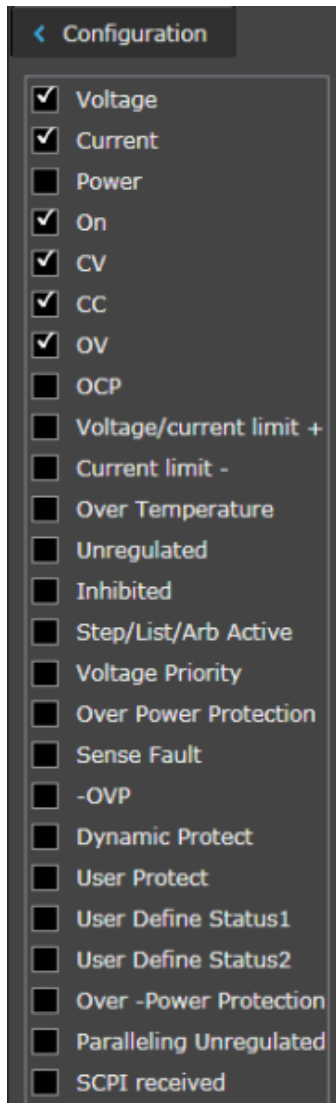

### Viewing Snapshot Events

Click on the pale blue dots on the timeline to view the user defined message that was placed into the BBR log . Refer to **Snapshot Event Tags** for information on how to place event messages into the BBR.

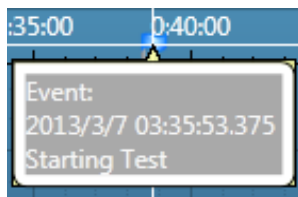

## Exporting the Snapshot Data

You can export the snapshot data to an Excel or CSV file. Select **Export** to export the snapshot data.

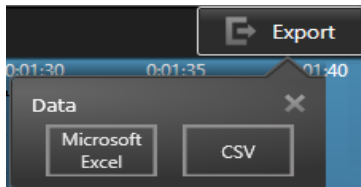

Select Microsoft Excel to export the data to Excel.

Select CSV to save the data in .csv format. The default file location is C:\Program Files\Keysight\PowerAssistant.

## Saving the Snapshot File

You can save and retrieve snapshot files on your computer.

- Click the **Disc** icon on top of the window to save the file. The default file location is C:\Program Files\Keysight\PowerAssistant. Rename the file, as the default filename is overwritten each time a new file is saved.
- Click the **Folder** icon to open any saved files with the Power Assistant.



# 6

## SCPI Programming Reference

**Introduction to the SCPI Language**

**Commands by Subsystem**

**Command Quick Reference**

**Reset State (\*RST)**

**SCPI Error Messages**

**Compatibility Commands**

### **IO Libraries and Instrument Drivers**

The Keysight IO Libraries Suite software is provided on the Keysight Automation Ready CD-ROM provided with your instrument. You can also download the Keysight IO Libraries Suite software, along with IVI-COM and LabVIEW drivers from the Keysight Developer Network at [www.keysight.com/find/adn](http://www.keysight.com/find/adn).

For detailed information about interface connections, refer to the Keysight USB/LAN/GPIB Interfaces Connectivity Guide, located on the Automation-Ready CD. Or download the guide at [www.keysight.com/find/connectivity](http://www.keysight.com/find/connectivity).

### **Web Interface**

The APS provides a Web interface that is built into the instrument. You can use this interface over LAN for remote access and control of the instrument via a Web browser. See [Using the Web Interface](#) for details.

### **Example Programs**

There are several example programs on the product page Web site at [www.keysight.com/find/APS](http://www.keysight.com/find/APS). These are application-focused programs that demonstrate different programming environments.

## Introduction to the SCPI Language

### Keywords

### Queries

### Command Separators and Terminators

### Syntax Conventions

### Parameter Types

### Device Clear

### Typical Command Processing Times

## Introduction

This instrument complies with the rules and conventions of the present SCPI version (see **SYSTem:VERSion?**).

SCPI (Standard Commands for Programmable Instruments) is an ASCII-based instrument command language designed for test and measurement instruments. SCPI has two types of commands, common and subsystem.

### IEEE-488.2 Common Commands

The IEEE-488.2 standard defines a set of common commands that perform functions such as reset, self-test, and status operations. Common commands always begin with an asterisk (\*), are three characters in length, and may include one or more parameters. The command keyword is separated from the first parameter by a blank space. Use a semicolon (;) to separate multiple commands as shown below:

### Subsystem Commands

Subsystem commands perform specific instrument functions. They are comprised of alphabetically arranged commands that extend one or more levels below the root in a hierarchical structure, also known as a *tree system*. In this structure, associated commands are grouped together under a common node or root, thus forming *subsystems*. A portion of the OUTPut subsystem is shown below to illustrate the tree system. Note that some [optional] commands have been included for clarity.

```

OUTPut
  [:STATe] OFF|0|ON|1
  :DELay
    :FALL <value>|MIN|MAX
    :RISE <value>|MIN|MAX
  :INHibit
    :MODE LATChing|LIVE|OFF

```

## Keywords

Keywords, also referred to as headers, are instructions recognized by the instrument. Common commands are also keywords.

OUTPut is the root keyword, DELay is a second-level keyword, FALL and RISE are third-level keywords. Colons ( : ) separate the keyword levels.

The command syntax shows most commands (and some parameters) as a mixture of upper- and lower-case letters. The upper-case letters indicate the abbreviated spelling for the command. For shorter program lines, you can send the abbreviated form. For better program readability, you can send the long form.

In the above examples, OUTP and OUTPUT are both acceptable forms. You can use upper- or lower-case letters. Therefore, OUTPUT, outp, and Outp are all acceptable. Other forms such as OUT, are not valid and will generate an error.

## Queries

Following a keyword with a question mark ( ? ) turns it into a query (Example: VOLTage?, VOLTage:TRIGgered?). If a query contains parameters, place the query indicator at the end of the last keyword, before the parameters. Insert a space between the query indicator and the first parameter.

You can query the programmed value of most parameters. For example, you can query the previously set OUTPut:DELay:FALL time by sending:

```
OUTPut:DELay:FALL?
```

You can also query the minimum or maximum allowable fall time as follows:

```
OUTPut:DELay:FALL? MIN
OUTPut:DELay:FALL? MAX
```

You must read back all the results of a query before sending another command to the instrument. Otherwise, a *Query Interrupted* error will occur and the unreturned data will be lost.

## Command Separators and Terminators

### Separators

Colons ( : ) separate keyword levels. Blank spaces must be used to separate command parameters from their corresponding keyword. If a command requires more than one parameter, use a comma to separate adjacent parameters. In the following example, the optional *startindex* and *points* parameters must be separated with a comma. Note the space between CURRent? and the first parameter.

```
FETCh:CURRent? [<start_index>, <points>]
```

Semicolons (;) separate commands within the same subsystem. This lets you send several subsystem commands within the same message string. For example, sending the following command string:

```
OUTPut:STATe ON;DELAy:RISE 1;FALL 2
```

is the same as sending the following commands:

```
OUTPut ON  
OUTPut:DELAy:RISE 1  
OUTPut:DELAy;FALL 2
```

Note that the semicolon follows the implied path of the hierarchical tree structure. In the above example, the optional :STATe keyword must follow the OUTput keyword to place the command parser at the second level in the hierarchy. This allows the use of the DELay keyword after the semicolon, since DELay is a second-level keyword. Next, the command parser is placed at the third level in the hierarchy by the :RISE keyword. This allows the use of the FALL keyword after the second semicolon, since FALL is a third-level keyword.

You can also combine commands of different subsystems within the same message string. In this case, you must use a colon to return the command parser to the root level in order to access another subsystem. For example, you could clear the output protection and check the status of the Operation Condition register in one message by using a root specifier as follows:

```
OUTPut:PROTEction:CLEar;:STATus:OPERation :CONDition?
```

Note the use of the colon *after* the semicolon in order to return the command parser to the root.

### Terminators

A command string sent to the instrument must terminate with a new line (<NL>) character. The IEEE-488 EOI (End-Or-Identify) message is interpreted as a <NL> character and can be used to terminate a command string in place of an <NL>. A carriage return followed by a new line (<CR><NL>) is also accepted. Command string termination will always reset the current SCPI command path to the root level.

### Syntax Conventions

- Triangle brackets (< >) indicate that you must specify a value for the enclosed parameter. For example, in the OUTPut:DELAy syntax statements shown above, the <value> parameter is enclosed in triangle brackets. The brackets are not sent with the command string. You must specify a value for the parameter (Example: "OUTP:DEL:FALL 0.1") unless you select another option shown in the syntax (Example: "OUTP:DEL:FALL MIN").
- A vertical bar (|) separates multiple parameter choices for a given command string. For example, LATChing|LIVE|OFF in the OUTPut:INHibit command indicates that you can specify "LATChing", "LIVE", or "OFF". The bar is not sent with the command string.

- Square brackets ( [ ] ) enclose some syntax elements – nodes and parameters for example. This indicates that the element is optional and can be omitted. The brackets are not sent with the command string. In the case of an optional parameter, if you do not specify a value for an optional parameter the instrument will ignore the parameter. In the FETCh:CURRent? example above, the optional <startindex> and <points> parameters let you return array data starting at startindex and containing the specified number of data points. If these parameters are not specified, the query returns all of the array data.
- Braces ( { } ) indicate parameters that may be repeated zero or more times. It is used especially for showing lists. The notation <value>{,<value>} shows that the first value must be entered, while additional values may be omitted or may be entered one or more times.

## Parameter Types

The SCPI language defines several data formats to be used in commands and queries.

### Numeric Parameters

Commands that require numeric parameters will accept all commonly used decimal representations of numbers including optional signs, decimal points, and scientific notation. If a command accepts only certain specific values, the instrument will automatically round the input numeric parameters to the accepted values. The following command requires a numeric parameter for the voltage value:

```
[SOURce:]VOLTage 50V|MIN|MAX
```

Note that special values for numeric parameters such as MINimum, MAXimum, and INfinity are also accepted. Instead of selecting a specific value for the voltage parameter, you can substitute MIN to set the voltage to its minimum allowable value, MAX to set it to its maximum allowable value.

You can also send engineering unit suffixes with numeric parameters (e.g., V for volts, A for amperes, W for Watts). All parameters values are in base units.

### Discrete Parameters

Discrete parameters are used to program settings that have a limited number of values (like IMMEDIATE, EXTERNAL, or BUS). They may have a short form and a long form just like command keywords. You can use upper- or lower-case letters. Query responses will always return the short form in all upper-case letters. The following command requires a discrete parameter for the display settings:

```
DISPlay:VIEW METER_VI|METER_VP|METER VIP
```

### Boolean Parameters

Boolean parameters represent a single binary condition that is either true or false. For a false condition, the instrument will accept "OFF" or "0". For a true condition, the instrument will accept "ON" or "1". When you query a Boolean setting, the instrument will always return "0" or "1". The following command requires a Boolean parameter:

```
DISPlay OFF|0|ON|1
```

### ASCII String Parameters

String parameters can contain virtually any set of ASCII characters. A string must begin and end with matching quotes; either with a single quote or a double quote. You can include the quote delimiter as part of the string by typing it twice without any characters in between. The following command uses a string parameter:

```
CALibrate:DATE "12/12/12"
```

### Arbitrary Block Program or Response Data

Definite-length block data <Block> allows any type of device-dependent data to be programmed or returned as a series of 8-bit binary data bytes. This is particularly useful for transferring large quantities of data or 8-bit extended ASCII codes.

### Device Clear

Device Clear is an IEEE-488 low-level bus message that you can use to return the instrument to a responsive state. Different programming languages and IEEE-488 interface cards provide access to this capability through their own unique commands. The status registers, the error queue, and all configuration states are left unchanged when a Device Clear message is received.

Device Clear performs the following actions:

- If a measurement is in progress, it is aborted.
- The instrument returns to the trigger idle state.
- The instrument's input and output buffers are cleared.
- The instrument is prepared to accept a new command string.

**NOTE**

The ABORt command is the recommended method to terminate an instrument operation.

### Typical Command Processing Times

The following table documents some typical, average command processing times for several types of setting commands and response queries. This can help you determine the impact of some commonly used SCPI commands on total test time. All times are in milliseconds.

Setting commands like VOLT <n> only account for the IO latency + command processing, not the time for the action to complete (like the output voltage to finish changing or output state completing turn on).

Query command times apply from when the command was sent to the instrument until the response is received.

Setting Commands	GPIB	LAN
Set the output voltage: VOLT <n>	0.5 ms	2.5 ms
Set the unit to the reset state: *RST	10.5 ms	11.5 ms
Query Commands		
Return the voltage setting: VOLT?	1.3 ms	5 ms
Return the output setting: OUT?	1 ms	5.5 ms
Return 10 point measurement: MEAS:VOLT?	6 ms	9.5 ms
Return 10 point fetch: FETC:VOLT?	1.5	5 ms
Return 1 NPLC measurement: MEAS:VOLT?	28 ms	32.5 ms
Return 1 NPLC fetch: FETC:VOLT?	5.5 ms	10 ms
Return 25 k point measurement: MEAS:VOLT?	180 ms	182 ms
Return 25 k point fetch: FETC:VOLT?	32.5 ms	36.7 ms
Return 25 k point ASCII array fetch: FETC:ARR:VOLT?	9267 ms	5818 ms
Return 25 k point binary array fetch: FETC:ARR:VOLT?	558 ms	537 ms

## Commands by Subsystem

**ABORt**

**CALibrate**

**DISPlay**

**FETCh**

**FORMat**

**HCOPy**

**IEEE-488 Common**

**INITiate**

**LXI**

**MEASure**

**OUTPut**

**SENSe**

[SOURce:]

**ARB**

**CURRent**

**DIGital**

**FUNction**

**LIST**

**POWER**

**RESistance**

**STEP**

**VOLTage**

**STATus**

**SYSTem**

**TRIGger**

**Status Tutorial**

**Trigger Tutorial**

## ABORt Subsystem

Abort commands cancel any triggered actions and returns the trigger system back to the Idle state. Abort commands are also executed with the \*RST command.

### ABORt:ACQuire

**ABORt:ELOG** N7900 models N6900 Opt 302

### ABORt:TRANsient

ABORt:ACQuire - Cancels any triggered measurements. It also resets the WTG-meas and MEAS-active bits in the Operation Status registers.

ABORt:ELOG - Stops external data logging. It also resets the WTG-meas and MEAS-active bits in the Operation Status registers.

ABORt:TRANsient - Cancels any triggered actions. It also resets the WTG-tran and TRAN-active bits in the Operation Status registers. Note that this command does not turn off continuous triggers if INITiate:CONTInuous:TRANsient ON has been programmed. In this case, the trigger system will automatically re-initiate.

Parameter	Typical Return
(none)	(none)
Aborts the triggered measurement: ABOR:ACQ	

**ARB Subsystem**

N7900 models

N6900 Opt 303

ARB commands program the constant-dwell arbitrary waveforms. Constant-dwell waveforms can have up to 65,535 points assigned to them, with the same dwell time for each point.

[SOURce:]

ARB

:COUNT <value> INFinity	Specifies the number of times the Arb repeats.
:CURRent	
:CDWell	
[:LEVel] <value>{,<value>} <Block>	Specifies the level of each point in the Arb.
:DWELl <value>	Specifies the dwell time of each point in the Arb.
:POINts?	Returns the number of points in the Arb.
:FUNction	
:TYPE CURRent VOLTage	Specifies either a voltage or current Arb.
:TERMinate	
:LAST 0 OFF 1 ON	Selects the output setting after the Arb ends.
:VOLTage	
:CDWell	
[:LEVel] <value>{,<value>} <Block>	Specifies the level of each point in the Arb.
:DWELl <value>	Specifies the dwell time of each point in the Arb.
:POINts?	Returns the number of points in the Arb.

**[SOURce:]ARB:COUNT <value>|MIN|MAX|INFinity**

**[SOURce:]ARB:COUNT? [MIN|MAX]**

Specifies the number of times the Arb repeats. Use the INFinity parameter to repeat the Arb continuously.

Parameter	Typical Return
1 – 256, *RST 1	<count>
Programs a repeat count of 10: ARB:COUN 10	

**[SOURce:]ARB:CURRent:CDWell[:LEVel] <value>{,<value>}|<Block>**

**[SOURce:]ARB:CURRent:CDWell[:LEVel]?**

**[SOURce:]ARB:VOLTage:CDWell[:LEVel] <value>{,<value>}|<Block>**

**[SOURce:]ARB:VOLTage:CDWell[:LEVel]?**

Specifies the level of each point in the Arb. Values are specified in either amperes or volts. The minimum and maximum values depend on the ratings of the unit.

Current and voltage Arbs share settings, so setting the current Arb resets the voltage Arb level to its default value and vice versa. For better performance, the list can be sent as single precision floating point values in definite length arbitrary block format instead of an ASCII list. The response format is dependent on the return format ASCII or REAL.

Parameter	Typical Return
-10.2% to 102% of current rating or 0 to 102% of voltage rating	<value> [,<value>] or <Block>
With power dissipator: up to -102% to 102% of current rating	
Programs a constant dwell Arb of 5 voltage points: ARB:VOLT:CDW 5,4,3,2,1	

**[SOURce:]ARB:CURRENT:CDWell:DWELL <value>**

**[SOURce:]ARB:CURRENT:CDWell:DWELL?**

**[SOURce:]ARB:VOLTage:CDWell:DWELL <value>**

**[SOURce:]ARB:VOLTage:CDWell:DWELL?**

Specifies the dwell time of each point in the Arb. Values are in seconds and are rounded to the nearest 10.24-microsecond increment.

Current and voltage Arbs share settings, so setting this parameter for a current Arb changes the voltage dwell value and vice versa.

Parameter	Typical Return
0.00001024 – 0.30, *RST 0.001	<dwell value>
Programs a constant dwell time of 0.2 seconds: ARB:CURRE:CDW:DWEL 0.2	

**[SOURce:]ARB:CURRENT:CDWell:POINTs?**

**[SOURce:]ARB:VOLTage:CDWell:POINTs?**

Returns the number of points in the Arb.

Parameter	Typical Return
(none)	<points>
Returns the number of current points in the Arb: ARB:CURRE:CDW:POIN?	

**[SOURce:]ARB:FUNCtion:TYPE CURRent|VOLTage**  
**[SOURce:]ARB:FUNCtion:TYPE?**

Specifies either a voltage or current Arb. Only one type of Arb may be output at a time. The selection must match the priority mode.

Parameter	Typical Return
CURRent VOLTage, *RST VOLTage	VOLT or CURR
Specifies a voltage Arb: ARB:FUNC:TYPE VOLT	

**[SOURce:]ARB:TERMinate:LAST 0|OFF|1|ON**  
**[SOURce:]ARB:TERMinate:LAST?**

Selects the output setting after the Arb ends. When ON (1), the output voltage or current remains at the last Arb value. The last Arb voltage or current value becomes the IMMEDIATE value when the ARB completes. When OFF (0), and also when the Arb is aborted, the output returns to the settings that were in effect before the Arb started.

Parameter	Typical Return
0 OFF 1 ON, *RST OFF	0 or 1
Terminate with the output at the last Arb value: ARB:TERM:LAST ON	

## CALibrate Subsystem

Calibrate commands calibrate the instrument.

**NOTE**

Read the **calibration section** before calibrating. Improper calibration reduces accuracy and reliability.

### CALibrate

:COUNT?	Returns the number of times the unit has been calibrated.
:CURRent	
[:LEVel] <value>	Calibrates the current programming and measurement.
:MEASure <value>	Calibrates the low range current measurement.
:SHARing	Calibrates the Imon signal for paralleled units.
:TC	Calibrates the temperature coefficient.
:DATA <value>	Enters the calibration value read by the external meter.
:DATE <"date">	Enters the calibration date in nonvolatile memory.
:LEVel P1 P2 P3	Advances to the next level in the calibration.
:PASSword <value>	Sets a numeric password to prevent unauthorized calibration.
:RESistance	
:BOUT	Calibrates the bottom out resistance.
:SAVE	Saves the calibration constants in non-volatile memory.
:STATe 0 OFF 1 ON	Enables or disables calibration mode.
:VOLTage	
[:LEVel] <value>	Calibrates the local voltage programming and measurement.
:CMRR	Calibrates the voltage common mode rejection ratio.

### CALibrate:COUNT?

Returns the number of times the unit has been calibrated. The count is incremented whenever the calibration (and date) is saved, the administration password is changed or reset, or the firmware is updated.

Parameter	Typical Return
(none)	<count>
Return the calibration count: CAL:COUNT?	

### CALibrate:CURRent[:LEVel] <value>

Calibrates the current programming and measurement. The value selects the range to calibrate.

Parameter	Typical Return
The maximum current of the output range.	(none)
Calibrates the current of the 10 A range: CAL:CURR 10	

**CALibrate:CURRent:MEASure <value>** N7900 models N6900 Opt 301

Calibrates the low range current measurement. The value selects the range to calibrate.

Parameter	Typical Return
The maximum current of the measurement range.	(none)
Calibrates the current of the 10 A measurement range: CAL:CURR:MEAS 10	

**CALibrate:CURRent:SHARing**

Calibrates the Imon signal for paralleled units.

Parameter	Typical Return
(none)	(none)
Calibrates the current sharing: CAL:CURR:SHAR	

**CALibrate:CURRent:TC** N7900 models N6900 Opt 301

Calibrates the temperature coefficient.

Parameter	Typical Return
(none)	(none)
Calibrates the temperature coefficient: CAL:CURR:TC	

**CALibrate:DATA <value>**

Enters the calibration value read by the external meter. You must first select a calibration level for the value being entered. Data values are expressed in base units - either volts or amperes, depending on which function is being calibrated.

Parameter	Typical Return
Numeric value	(none)
Specify calibration value 0.0237: CAL:DATA 2.37E-2	

**CALibrate:DATE <"date">****CALibrate:DATE?**

Enters the calibration date in nonvolatile memory. Enter any ASCII string up to 15 characters. The query returns the date. Enclose string parameters in single or double quotes.

Parameter	Typical Return
<"date"> String program data.	<last cal date>
Enters the calibration date: CAL:DATE "12/12/12"	

### CALibrate:LEVel P1|P2|P3 CALibrate:LEVel?

Advances to the next level in the calibration. P1 is the first level; P2 is the second; P3 is the third.

Parameter	Typical Return
P1 P2 P3	(none)
Selects the first calibration point: CAL:LEV P1	

- Some calibration sequences may require some settling time after sending CAL:LEV but before reading the data from the DVM and sending CAL:DATA.

### CALibrate:PASSword <password>

Sets a numeric password to prevent unauthorized calibration. This is the same as the **Admin** password.

Parameter	Typical Return
<password> A numeric value of up to 15 digits	(none)
Set a new password to a value of 1234: CAL:PASS 1234	

- If the password is set to 0, password protection is removed and the ability to enter calibration mode is unrestricted. The as-shipped setting is 0 (zero).
- To change the password: unsecure calibration memory with old code, then set the new code.
- If you forget your password, refer to **Calibration Switches**.
- This setting is non-volatile; it will not be changed by power cycling or \*RST.

### CALibrate:RESistance:BOUT

Calibrates the bottom out resistance.

Parameter	Typical Return
(none)	(none)
Calibrates the bottom out resistance: CAL:RES:BOUT	

**CALibrate:SAVE**

Saves the calibration constants in non-volatile memory. Do this at the end of the calibration to avoid losing changes.

Parameter	Typical Return
(none)	(none)
Store calibration constants into non-volatile memory: <code>CAL:SAVE</code>	

**CALibrate:STATE 0|OFF|1|ON [, <password>]**  
**CALibrate:STATE?**

Enables or disables calibration mode. Calibration mode must be enabled for the instrument to accept any calibration commands. The first parameter specifies the state. The second optional parameter is the password.

Parameter	Typical Return
0 OFF 1 ON, *RST OFF	0 or 1
<password> a numeric value up to 15 digits	(none)
Disable calibration: <code>CAL:STAT OFF</code> Enable calibration: <code>CAL:STAT ON [,value]</code>	

<password> is required if it has been set to a non-zero value.

**CALibrate:VOLTage[:LEVel] <value>**

Calibrates the local voltage programming and measurement. The value selects the range to calibrate.

Parameter	Typical Return
The maximum voltage of the output range.	(none)
Calibrates the voltage of the 20 V range: <code>CAL:VOLT 20</code>	

**CALibrate:VOLTage:CMRR**

Calibrates the voltage common mode rejection ratio.

Parameter	Typical Return
(none)	(none)
Calibrates the common mode rejection ratio: <code>CAL:VOLT:CMRR</code>	

## CURRent Subsystem

Current commands program the output current of the instrument.

[SOURce:]		
CURRent		
[:LEVel]		
[:IMMediate]		
[:AMPLitude] <value>	Sets the output current when in current priority mode	
:TRIGgered		
[:AMPLitude] <value>	Sets the triggered output current	
:LIMit		
[:POSitive]		
[:IMMediate]		
[:AMPLitude] <value>	Sets the current limit when in voltage priority mode.	
:NEGative		
[:IMMediate]		
[:AMPLitude] <value>	Sets the current limit when in voltage priority mode.	
:MODE FIXed STEP LIST ARB	Sets the transient mode.	
:PROTection		
:DELay		
[:TIME] <value>	Sets the over-current protection delay.	
:STARt SCHange CCTRans	Specifies what starts the over-current protection delay timer.	
:STATe 0 OFF 1 ON	Enables or disables the over-current protection.	
:SHARing		
[:STATe] 0 OFF 1 ON	Enables or disables current sharing on paralleled units.	
:SLEW		
[:IMMediate] <value> INFinity	Sets the current slew rate.	
:MAXimum 0 OFF 1 ON	Enables or disables the maximum slew rate override.	

**[SOURce:]CURRent[:LEVel][:IMMediate][:AMPLitude] <value>|MIN|MAX**

**[SOURce:]CURRent[:LEVel][:IMMediate][:AMPLitude]? [MIN|MAX]**

**[SOURce:]CURRent[:LEVel]:TRIGgered[:AMPLitude] <value>|MIN|MAX**

**[SOURce:]CURRent[:LEVel]:TRIGgered[:AMPLitude]? [MIN|MAX]**

Sets the immediate or triggered current level when the output is operating in current priority mode. The triggered level is a stored value that is transferred to the output when an output Step is triggered. Units are in amperes. The maximum value depends on the current rating of the unit. The minimum value is the most negative value.

Parameter	Typical Return
-10.2% to 102% of rating, *RST 0 With power dissipator: up to -102% to 102% of rating	<current level>
Sets the positive current limit to 2 A: CURR:LIM 2	

**[SOURce:]CURRent:LIMit[:POSitive][:IMMEDIATE][:AMPLitude] <value>|MIN|MAX**  
**[SOURce:]CURRent:LIMit[:POSitive][:IMMEDIATE][:AMPLitude]? [MIN|MAX]**  
**[SOURce:]CURRent:LIMit:NEGative[:IMMEDIATE][:AMPLitude] <value>|MIN|MAX**  
**[SOURce:]CURRent:LIMit:NEGative[:IMMEDIATE][:AMPLitude]? [MIN|MAX]**

Sets the current limit when in voltage priority mode. Units are in amperes. The maximum value depends on the current rating of the unit. The minimum value is the most negative value.

Parameter	Typical Return
Positive: 0 to 102% of rating, *RST 1.02% of rating	<+current limit>
Negative: -10.2% of rating to 0, *RST -10.2% of rating	<-current limit>
Negative with power dissipator: up to -102% of rating to 0	
Sets the positive current limit to 2 A: CURR:LIM 2	
Sets the negative current limit to -2 A: CURR:LIM:NEG -2	

**[SOURce:]CURRent:MODE FIXed|STEP|LIST|ARB**  
**[SOURce:]CURRent:MODE?**

Sets the transient mode. This determines what happens to the output current when the transient system is initiated and triggered.

**FIXed** keeps the output current at its immediate value.

**STEP** steps the output to the triggered level when a trigger occurs.

**LIST** causes the output to follow the list values when a trigger occurs.

**ARB** causes the output to follow the arbitrary waveform values when a trigger occurs.

Parameter	Typical Return
FIXed STEP LIST ARB, *RST FIXed	FIX, STEP, LIST, or ARB
Sets the current mode to Step: CURR:MODE STEP	

**[SOURce:]CURRent:PROTection:DELAy[:TIME] <value>|MIN|MAX**  
**[SOURce:]CURRent:PROTection:DELAy[:TIME]? [MIN|MAX]**

Sets the over-current protection delay. The over-current protection function will not be triggered during the delay time. After the delay time has expired, the over-current protection function will be active. This prevents momentary changes in output status from triggering the over-current protection function. Values up to 255 milliseconds can be programmed, with a resolution of 1 millisecond.

Parameter	Typical Return
0 – 0.255, *RST 0.020 s	<delay value>
Sets the protection delay to 0.2 seconds: CURR:PROT:DEL 0.2	

- The operation of over-current protection is affected by the setting of the current protection delay start event, which is specified by CURRent:PROTection:DELAy:START.

**[SOURce:]CURRENT:PROTECTION:DELAY:START SChange|CCTrans**  
**[SOURce:]CURRENT:PROTECTION:DELAY:START?**

Specifies what starts the over-current protection delay timer. **SChange** starts the over-current delay whenever a command changes the output settings. **CCTrans** starts the over-current delay timer by any transition of the output into current limit mode.

Parameter	Typical Return
SChange CCTrans, *RST SChange	SCH or CCTR
Selects the CCTrans as the current protection delay mode: CURRE:PROT:DEL:STAR CCTR	

**[SOURce:]CURRENT:PROTECTION:STATE 0|OFF|1|ON**  
**[SOURce:]CURRENT:PROTECTION:STATE?**

Enables or disables the over-current protection. If the over-current protection function is enabled and the output goes into current limit, the output is disabled and the Questionable Condition status register OCP bit is set.

Parameter	Typical Return
0 OFF 1 ON, *RST OFF	0 or 1
Enable the current protection state: CURRE:PROT:STAT ON	

- An over-current condition can be cleared with OUTPUT:PROTECTION:CLEAR after the cause of the condition is removed.

**[SOURce:]CURRENT:SHARING[:STATE] 0|OFF|1|ON**  
**[SOURce:]CURRENT:SHARING[:STATE]?**

Enables or disables current sharing on paralleled units. This command must be sent to each unit that is paralleled. When enabled, the load current is shared equally among the paralleled outputs. The rear panel **Share** terminals must be connected; otherwise an error will occur.

Parameter	Typical Return
0 OFF 1 ON, *RST OFF	0 or 1
To enable current sharing: CURRE:SHAR ON	

**[SOURce:]CURRENT:SLEW[:IMMEDIATE] <value>|MIN|MAX|INFINITY**  
**[SOURce:]CURRENT:SLEW[:IMMEDIATE]? [MIN|MAX]**

Sets the current slew rate. The slew rate is set in amps per second and affects all programmed current changes, including those due to the output state turning on or off. The slew rate can be set to any value between 0 and 9.9E+37. For very large values, the slew rate will be limited by the analog performance of the output circuit. The keywords MAX or INFINITY set the slew rate to maximum.

Parameter	Typical Return
0 – 9.9E+37, *RST MAX	<max value>
Sets the output slew rate to 1 A per second: <code>CURR:SLEW 1</code>	

- The query returns the value that was sent, unless the value is less than the minimum slew rate, in which case the minimum value is returned. The resolution of the slew setting is also the minimum value, which can be queried using `CURR:SLEW? MIN`. The exact value varies slightly according to calibration.

**[SOURce:]CURRENT:SLEW:MAXIMUM 0|OFF|1|ON**  
**[SOURce:]CURRENT:SLEW:MAXIMUM?**

Enables or disables the maximum slew rate override. When enabled, the slew rate is set to its maximum value. When disabled, the slew rate is set to the immediate value set by the `[SOURce:]CURRENT:SLEW` command. Use `[SOURce:]CURRENT:SLEW? MAX` to query the maximum slew rate that was set.

Parameter	Typical Return
0 OFF 1 ON, *RST ON	0 or 1
Enable the maximum slew rate: <code>CURR:SLEW:MAX ON</code>	

- The `[SOURce:]CURRENT:SLEW:MAX` command is coupled to the `[SOURce:]CURRENT:SLEW` command. If `[SOURce:]CURRENT:SLEW` sets the rate to MAX or INFINITY, `[SOURce:]CURRENT:SLEW:MAX` is enabled. If the slew rate is set to any other value, `[SOURce:]CURRENT:SLEW:MAX` is disabled.

## DIGital Subsystem

Digital commands program the digital control port on the rear panel of the instrument.

[SOURce:]

DIGital

:INPut

:DATA?

Reads the state of the digital control port.

:OUTPut

:DATA <value>

Sets the state of the digital control port.

:PIN<1-7>

:FUNction <function>

Sets the function of the pins. DIO |DINPut |EXPRession<1-8> |FAULt |INHibit |ONCouple |OFFCouple |TOUTput |TINPut

:POLarity POSitive|NEGative

Sets the polarity of the pins.

:TOUTput

:BUS

[[:ENABLE] 0|OFF|1|ON

Enables or disables BUS triggers on digital port pins.

### [SOURce:]DIGital:INPut:DATA?

Reads the state of the digital control port. Returns the binary-weighted value of the state of pins 1 through 7 in bits 0 through 6 respectively.

Parameter	Typical Return
(none)	<bit value>
Reads the state of the digital control port: DIG:INP:DATA?	

### [SOURce:]DIGital:OUTPut:DATA <value>

### [SOURce:]DIGital:OUTPut:DATA?

Sets the state of the digital control port. This only affects the pins whose function has been set to Digital IO operation. The port has seven signal pins and a digital ground pin. In the binary-weighted value that is written to the port, the pins are controlled according to the following bit assignments:

Pin	1	2	3	4	5	6	7
Bit number	0	1	2	3	4	5	6
Decimal value	1	2	4	8	16	32	64

Bit values corresponding to digital port pins that are not configured as DIO are ignored.

Parameter	Typical Return
0 – 127, *RST 0	<bit value>
Programs pins 1, 3, and 5 on: DIG:OUTP:DATA?	

**[SOURce:]DIGital:PIN<1-7>:FUNction <function>**  
**[SOURce:]DIGital:PIN<1-7>:FUNction?**

Sets the function of the pins. The functions are saved in non-volatile memory.

<b>DIO</b>	General-purpose ground-referenced digital input/output function.
<b>DINPut</b>	Digital input-only mode.
<b>EXPRession&lt;1-8&gt;</b>	A user-defined expression drives the pin.
<b>FAULt</b>	Pin 1 functions as an isolated fault output. Pin 2 is common for pin 1
<b>INHibit</b>	Pin 3 functions as an inhibit input.
<b>ONCouple</b>	Pins 4 -7 synchronize the output On state.
<b>OFFCouple</b>	Pins 4 -7 synchronize the output Off state.
<b>TINPut</b>	A trigger input function.
<b>TOUTput</b>	A trigger output function

Parameter	Typical Return
DIO   DINPut   EXPRession<1-8>   FAULt   INHibit   ONCouple   OFFCouple TINPut   TOUTput	DIO, DINP, EXPR<n>, FAUL, INH, ONC, OFFC, TINP, or TOUT

Sets pin 1 to FAULt mode: `DIG:PIN1:FUNC FAUL`

**[SOURce:]DIGital:PIN<1-7>:POLarity POSitive|NEGative**  
**[SOURce:]DIGital:PIN<1-7>:POLarity?**

Sets the polarity of the pins.

**POSitive** means a logical true signal is a voltage high at the pin. For trigger inputs and outputs, positive means a rising edge.

**NEGative** means a logical true signal is a voltage low at the pin. For trigger inputs and outputs, negative means a falling edge.

Parameter	Typical Return
POSitive NEGative	POS or NEG

Sets pin 1 to POSitive polarity: `DIG:PIN1:POL POS`

- The pin polarities are saved in non-volatile memory.

**[SOURce:]DIGital:TOUTput:BUS[:ENABLE] 0|OFF|1|ON**  
**[SOURce:]DIGital:TOUTput:BUS[:ENABLE]?**

Enables or disables BUS triggers on digital port pins. This allows a BUS trigger to be sent to any digital port pin that has been configured as a trigger output. A trigger out pulse is generated when the state is on and a bus trigger is received. A BUS trigger is generated using the \*TRG command.

Parameter	Typical Return
0 OFF 1 ON, *RST OFF	0 or 1
Enable BUS triggered signals on the digital pins: CURR:TOUT:BUS ON	

- The query returns 0 (OFF) if the trigger signal will NOT be generated with a BUS trigger command, and 1 (ON) if a trigger signal will be generated with a BUS trigger command.

## DISPlay Subsystem

Display commands control the front panel display.

**DISPlay[:WINDow][:STATe] 0|OFF|1|ON**  
**DISPlay[:WINDow][:STATe]?**

Turns the front panel display on or off.

Parameter	Typical Return
0 OFF 1 ON, *RST ON	0 or 1
Turns the front panel display off: <code>DISP OFF</code>	

**DISPlay[:WINDow]:VIEW METER\_VI|METER\_VP|METER\_VIP**  
**DISPlay[:WINDow]:VIEW?**

Selects the parameters to display on the front panel.

METER\_VI displays output voltage and current.

METER\_VP displays output voltage and power.

METER\_VIP displays output voltage, current, and power.

Parameter	Typical Return
METER_VI METER_VP METER_VIP, *RST METER_VI	METER_VI, METER_VP, or METER_VIP
To display voltage and power: <code>DISP:VIEW METER_VP</code>	

**DISPlay:SAVer[:STATe] 0|OFF|1|ON**  
**DISPlay:SAVer[:STATe]?**

Turns the front panel screen saver on or off.

Parameter	Typical Return
0 OFF 1 ON, *RST OFF	0 or 1
Turns the front panel screen saver on: <code>DISP:SAV ON</code>	

## FETCh Subsystem

Fetch commands return measurement data that has been previously acquired. FETCh queries do not generate new measurements, but allow additional measurement calculations from the same acquired data. The data is valid until the next MEASure or INITiate command occurs.

### FETCh

#### [ :SCALar ]

##### :CURRent

[ :DC ]? [ <start\_index>, <points> ] Returns the averaged measurement.

:ACDC? Returns the RMS measurement (AC + DC).

:HIGH? Returns the High level of a pulse waveform.

:LOW? Returns the Low level of a pulse waveform.

:MAXimum? Returns the maximum or minimum value.

:MINimum?

##### :POWER

[ :DC ]? Returns the averaged measurement.

:MAXimum? Returns the maximum or minimum value.

:MINimum?

##### :VOLTage

[ :DC ]? [ <start\_index>, <points> ] Returns the averaged measurement.

:ACDC? Returns the RMS measurement (AC + DC).

:HIGH? Returns the High level of a pulse waveform.

:LOW? Returns the Low level of a pulse waveform.

:MAXimum? Returns the maximum or minimum value.

:MINimum?

:AHOuR? [ IGNORE\_OVLD ] Returns the accumulated amp-hours.

#### :ARRAY

##### :CURRent

[ :DC ]? [ <start\_index>, <points> ] Returns the instantaneous measurement.

##### :POWER

[ :DC ]? Returns the instantaneous measurement.

##### :VOLTage

[ :DC ]? [ <start\_index>, <points> ] Returns the instantaneous measurement.

:ELOG? <maxrecords> Returns the most recent external datalog records.

:WHOuR? [ IGNORE\_OVLD ] Returns the accumulated watt-hours.

**FETCh[:SCALar]:CURRent[:DC]? [<start\_index>, <points>]**

**FETCh[:SCALar]:VOLTage[:DC]? [<start\_index>, <points>]**

**FETCh[:SCALar]:POWer[:DC]? [<start\_index>, <points>]**

Returns the averaged measurement. Values returned are either in amperes, volts, or watts.

Optional parameters specify a subset starting at <startindex> and of length <points>.

**N7900 models**

**N6900 Opt 302**

Parameter	Typical Return
<startindex> the start index	<DC value>
<points> the number of points	
Returns the measured DC current <code>FETC:CURR?</code>	

**FETCh[:SCALar]:CURRent:ACDC?**

**FETCh[:SCALar]:VOLTage:ACDC?**

Returns the RMS measurement (AC + DC). Values returned are either in amperes, or volts.

Parameter	Typical Return
(none)	<ACDC value>
Returns the measured RMS voltage <code>FETC:VOLT:ACDC?</code>	

**FETCh[:SCALar]:CURRent:HIGH?**

**FETCh[:SCALar]:VOLTage:HIGH?**

Returns the High level of a pulse waveform. Values returned are either in amperes, or volts. See [Measurement Types](#).

Parameter	Typical Return
(none)	<HIGH value>
Returns the measured high level current <code>FETC:CURR:HIGH?</code>	

**FETCh[:SCALar]:CURRent:LOW?**

**FETCh[:SCALar]:VOLTage:LOW?**

Returns the Low level of a pulse waveform. Values returned are either in amperes, or volts. See [Measurement Types](#).

Parameter	Typical Return
(none)	<LOW value>
Returns the measured low level voltage <code>FETC:VOLT:LOW?</code>	

**FETCh[:SCALar]:CURRent:MAXimum?**  
**FETCh[:SCALar]:VOLTage:MAXimum?**  
**FETCh[:SCALar]:POWer:MAXimum?**  
**FETCh[:SCALar]:CURRent:MINimum?**  
**FETCh[:SCALar]:VOLTage:MINimum?**  
**FETCh[:SCALar]:POWer:MINimum?**

Returns the maximum or minimum value. Values returned are either in amperes, volts, or watts.

Parameter	Typical Return
(none)	<MIN value> or <MAX value>
Returns the measured maximum current	FETC:CURR:MAX?
Returns the measured maximum voltage	FETC:VOLT:MAX?
Returns the measured minimum power	FETC:POW:MIN?

- FETC:POW:MIN? and FETC:POW:MAX? are only available on units with firmware revisions A.02.01.1256 and B.02.01.1256 and up. See [Firmware Update](#).

**FETCh:AHOuR? [IGNORE\_OVLD]**  
**FETCh:WHOUr? [IGNORE\_OVLD]**

FETCh:AHOuR? Returns the accumulated amp-hours.

FETCh:WHOUr? – Returns the accumulated watt-hours.

Refer to [Amp-Hour and Watt-Hour Measurements](#) for details.

If any measurement sample was overrange, the query returns SCPI Not a Number (9.91E37). If the optional IGNORE\_OVLD parameter is sent, the accumulated measurement will be returned even if some samples were outside of the measurement range.

Parameter	Typical Return
IGNORE_OVLD ignore overload measurements	<amp-hours> or <watt-hours>
Returns the amp-hour measurement	FETC:AHO?

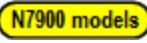
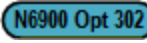
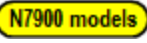
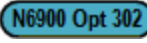
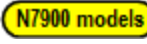
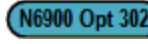
**FETCh:ARRAy:CURRent[:DC]? [<start\_index>, <points>]**    
**FETCh:ARRAy:VOLTage[:DC]? [<start\_index>, <points>]**    
**FETCh:ARRAy:POWer[:DC]? [<start\_index>, <points>]**  

Returns the instantaneous measurement. Values returned are either in amperes, volts, or watts. Optional parameters specify a subset starting at <startindex> and of length <points>.

The return format depends on the settings of the FORMat:BORDER and FORMat[:DATA] commands. When the data format is set to ASCII, returned values are comma separated. When the data format is set to REAL, data is returned as single precision floating point values in definite length arbitrary block response format.

## 6 SCPI Programming Reference

Parameter	Typical Return
[<startindex>] the start index	<value> [, <value>]
[<points>] the number of points	or <Block>
Returns the measured current array <code>FETC:ARR:CURR?</code>	
Returns the measured voltage array <code>FETC:ARR:VOLT?</code>	
Returns the measured power array <code>FETC:ARR:POW?</code>	

### **FETCh:ELOG? <maxrecords>**

Returns the most recent external datalog records. Data must be read from the buffer periodically to avoid the buffer overflowing. Whenever data is read using `FETCh:ELOG?` then that buffer space is made available in the instrument for storing more acquired data.

Maxrecords is the maximum number of records of datalog data that the controller will return.

The return format depends on the settings of the `FORMat:BORDER` and `FORMat[:DATA]` commands. When the data format is set to ASCII, returned values are comma separated. When the data format is set to REAL, data is returned as single precision floating point values in definite length arbitrary block response format.

Parameter	Typical Return
[<maxrecords>] the number of records returned (1 to 16,384)	<value> [, <value>] or <Block>
Returns 100 data records <code>FETC:ELOG? 100</code>	

## FORMat Subsystem

FORMat commands specify the format for transferring measurement data.

### FORMat[:DATA] ASCII|REAL FORMat[:DATA]?

Specifies the format of the returned data. This is used by queries that can return a block of data. **ASCII** returns data as ASCII bytes in numeric format as appropriate. The numbers are separated by commas. **REAL** returns data in a definite length block as IEEE single precision floating point values. In this case the 4 bytes of each value can be returned in either big-endian or little-endian byte order, determined by the FORMat:BORDER setting.

Parameter	Typical Return
ASCII REAL, *RST ASCII	ASCII or REAL
Sets the data format to ASCII: <code>FORMat ASCII</code>	

- The data format is used by a small sub set of queries that can return large quantities of data.

### FORMat:BORDER NORMAl|SWAPped FORMat:BORDER?

Specifies how binary data is transferred. This only applies when the FORMat:DATA is set to REAL. **NORMAl** transfers data in normal order. The most significant byte is returned first, and the least significant byte is returned last (big-endian). **SWAPped** transfers data in swapped-byte order. The least significant byte is returned first, and the most significant byte is returned last (little-endian).

Parameter	Typical Return
NORMAl SWAPped, *RST NORMAl	NORM or SWAP
Sets the data transfer to Swapped: <code>FORM:BORD SWAP</code>	

- The byte order is used when fetching real data from SCPI measurements.

**FUNCTION Command**

**[SOURce:]FUNCTION CURRent|VOLTage**  
**[SOURce:]FUNCTION?**

Sets the output regulation - voltage priority or current priority. In voltage priority mode the output is controlled by a constant voltage feedback loop, which maintains the output voltage at its programmed setting. In current priority mode the output is controlled by a constant current feedback loop, which maintains the output current at its positive or negative programmed setting.

Parameter	Typical Return
CURRent VOLTage, *RST VOLTage	CURR or VOLT
Sets the output regulation to current priority: FUNC CURR	

## HCOPY Subsystem

HCOPY commands return the display image.

### HCOPY:SDUMp:DATA? [BMP|GIF|PNG]

Returns an image of the front panel display. The format may be specified by the optional parameter. If no format is specified, the format is determined by HCOPY:SDUMp:DATA:FORMat.

The response is a SCPI 488.2 definite length binary block of the form: #<nonzero digit><digits><8 bit data-bytes> where:

<nonzero digit> specifies the number of digits to follow,  
 <digits> specify the number of 8 bit data bytes to follow, and  
 <8 bit data bytes> contain the data to be transferred.

Parameter	Typical Return
[BMP GIF PNG]	<Block>
Returns the image in GIF format: HCOP:SDUM:DATA? GIF	

### HCOPY:SDUMp:DATA:FORMat BMP|GIF|PNG HCOPY:SDUMp:DATA:FORMat?

Specifies the format for front panel images returned.

Parameter	Typical Return
BMP GIF PNG, *RST PNG	BMP, GIF, or PNG
Specify GIF as the image format: HCOP:SDUM:DATA:FORM GIF	

## IEEE-488 Common Commands

IEEE-488 Common commands generally control overall instrument functions, such as reset, status, and synchronization. All common commands consist of a three-letter mnemonic preceded by an asterisk: \*RST \*IDN? \*SRE 8.

*CLS	Clear status command.
*ESE <value>	Event status enable command and query.
*ESR?	Event status event query.
*IDN?	Identification Query.
*LRN?	Returns a sequence of SCPI commands.
*OPC	Sets the OPC (operation complete) bit in the standard event register.
*OPC?	Returns a 1 to the output buffer when all pending operations complete.
*OPT?	Returns a string identifying any installed options.
*RCL <value>	Recalls a saved instrument state.
*RST	Resets the instrument to pre-defined values that are either typical or safe.
*SAV <value>	Saves the instrument state to one of ten non-volatile memory locations.
*SRE <value>	Service request enable command and query.
*STB?	Status byte query.
*TRG	Trigger command.
*TST?	Self-test query.
*WAI	Pauses additional command processing until all pending operations are complete.

### \*CLS

Clear status command. Clear Status Command. Clears the **event registers** in all register groups. Also clears the status byte and error queue. If \*CLS immediately follows a program message terminator (<NL>), then the output queue and the MAV bit are also cleared. Refer to **Status Tutorial** for more information.

Parameter	Typical Return
(none)	(none)
Clear event registers, status byte, and error queue: *CLS	

### \*ESE <value>

#### \*ESE?

Event status enable command and query. Sets the value in the **enable register** for the **Standard Event Status** group. Each set bit of the register enables a corresponding event. All enabled events are logically ORed into the ESB bit of the status byte. The query reads the enable register. Refer to **Status Tutorial** for more information.

Parameter	Typical Return
A decimal value corresponding to the binary-weighted sum of the register's bits.	<bit value>
Enable bits 3 and 4 in the enable register: *ESE 24	

- The value returned is the binary-weighted sum of all bits set in the register. For example, to enable bit 2 (decimal value = 4), bit 4 (decimal value = 16), the corresponding decimal value would be 20 (4 + 16).
- Any or all conditions can be reported to the ESB bit through the enable register. To set the enable register mask, write a decimal value to the register using \*ESE.
- \*CLS does not clear the enable register, but does clear the **event register**.

### \*ESR?

Event status event query. Reads and clears the **event register** for the **Standard Event Status** group. The event register is a read-only register, which latches all standard events. Refer to **Status Tutorial** for more information.

Parameter	Typical Return
(none)	<bit value>
Read event status enable register: *ESR?	

- The value returned is the binary-weighted sum of all bits set in the register.
- Any or all conditions can be reported to the ESB bit through the enable register. To set the enable register mask, write a decimal value to the register using \*ESE.
- Once a bit is set, it remains set until cleared by this query or \*CLS.

### \*IDN?

Identification Query. Returns instrument's identification string, which contains four comma-separated fields. The first field is the manufacturer's name, the second field is the instrument model number, the third field is the serial number, and the fourth field is the firmware revision.

Parameter	Typical Return
(none)	Agilent Technologies,N7915A,MY12345678,A.01.01
Return the instrument's identification string: *IDN?	

### \*LRN?

Returns a sequence of SCPI commands. These can later be used to put the instrument in the same state that it was in when the \*LRN? query was sent.

## 6 SCPI Programming Reference

Parameter	Typical Return
(none)	ASCII string with semicolon-separated fields
Returns the learn string: *LRS?	

### \*OPC

Sets the OPC (operation complete) bit in the standard event register. This occurs at the completion of the pending operation. Refer to [Status Tutorial](#) for more information.

Parameter	Typical Return
(none)	(none)
Set the Operation Complete bit: *OPC	

- The purpose of this command is to synchronize your application with the instrument.
- Used in conjunction with initiated acquisitions, initiated transients, output state changes, and output to settling time to provide a way to poll or interrupt the computer when these pending operations complete.
- Other commands may be executed before the operation complete bit is set.
- The difference between \*OPC and \*OPC? is that \*OPC? returns "1" to the output buffer when the current operation completes.

### \*OPC?

Returns a 1 to the output buffer when all pending operations complete. The response is delayed until all pending operations complete.

Parameter	Typical Return
(none)	1
Return a 1 when commands complete: *OPC?	

- The purpose of this command is to synchronize your application with the instrument.
- Other commands cannot be executed until this command completes.

### \*OPT?

Returns a string identifying any installed options. A 0 (zero) indicates no options are installed.

Parameter	Typical Return
(none)	OPT 760
Returns installed options *OPT?	

**\*RCL <0-9>**

Recalls a saved instrument state. This restores the instrument to a state that was previously stored in locations 0 through 9 with the \*SAV command. All instrument states are recalled except: (1) trigger systems are set to the Idle state, (2) calibration is disabled, (3) all list settings are set to their \*RST values, and (4) non-volatile settings are not affected.

Parameter	Typical Return
0 - 9	(none)
Recall state from location 1: *RCL 1	

- Location 0 is automatically recalled at power turn-on when the Output Power-On state is set to RCL 0.
- Stored instrument states are not affected by \*RST.

**\*RST**

Resets the instrument to pre-defined values that are either typical or safe. These settings are described in [Reset State](#).

Parameter	Typical Return
(none)	(none)
Reset the instrument: *RST	

- \*RST forces the ABORt commands. This cancels any measurement or transient actions presently in process. It resets the WTG-meas, MEAS-active, WTG-tran, and TRAN-active bits in the Operation Status registers.

**\*SAV <0-9>**

Saves the instrument state to one of ten non-volatile memory locations.

Parameter	Typical Return
0 - 9	(none)
Save state to location 1: *SAV 1	

- If a particular state is desired at power-on, it should be stored in location 0. Location 0 is automatically recalled at power turn-on when the Output Power-On state is set to RCL 0.
- List data and the calibration state is NOT saved as part of the \*SAV operation.
- Data saved in non-volatile memory, described under [Non-Volatile Settings](#), is not affected by the \*SAV command.
- When shipped, locations 0 through 9 are empty.

**\*SRE <value>****\*SRE?**

Service request enable command and query. This sets the value of the Service Request Enable register. This determines which bits from the **Status Byte Register** are summed to set the Master Status Summary (MSS) bit and the Request for Service (RQS) summary bit. A 1 in any Service Request Enable register bit position enables the corresponding Status Byte register bit. All such enabled bits are then logically OR-ed to cause the MSS bit of the Status Byte register to be set. Refer to **Status Tutorial** for more information.

Parameter	Typical Return
A decimal value corresponding to the binary-weighted sum of the register's bits.	<bit value>
Enable bit 3 and bit 4 in the enable register: *SRE 24	

- When a serial poll is conducted in response to SRQ, the RQS bit is cleared, but the MSS bit is not. When \*SRE is cleared (by programming it with 0), the power supply cannot generate an SRQ to the controller.

**\*STB?**

Status byte query. Reads the **Status Byte Register**, which contains the status summary bits and the Output Queue MAV bit. The Status Byte is a read-only register and the bits are not cleared when it is read. Refer to **Status Tutorial** for more information.

Parameter	Typical Return
(none)	<bit value>
Read status byte: *STB?	

**\*TRG**

Trigger command. Generates a trigger when the trigger subsystem has BUS selected as its source. The command has the same effect as the Group Execute Trigger (<GET>) command.

Parameter	Typical Return
(none)	(none)
Generates an immediate trigger: *TRG	

**\*TST?**

Self-test query. Performs a instrument self-test. If self-test fails, one or more error messages will provide additional information. Use SYSTem:ERRor? to read error queue. See **SCPI Error Messages** for more information.

Parameter	Typical Return
(none)	0 (pass) or +1 (failed)
Perform self-test: *TST?	

- The power-on self-test is the same self-test performed by \*TST.
- \*TST? also forces an \*RST command.

### **\*WAI**

Pauses additional command processing until all pending operations are complete. See **OPC** for more information.

Parameter	Typical Return
(none)	(none)
Wait until all pending operations complete. *WAI	

- \*WAI can only be aborted by sending the instrument a Device Clear command.

## INITiate Subsystem

Initiate commands initialize the trigger system. This moves the trigger system from the "idle" state to the "wait-for-trigger" state; which enables the instrument to receive triggers. An event on the selected trigger source causes the trigger to occur.

### INITiate[:IMMediate]:ACQuire

### INITiate[:IMMediate]:ELOG

### INITiate[:IMMediate]:TRANsient

INITiate:ACQuire - Initiates the measurement trigger system.

INITiate:ELOG - Initiates external data logging.

INITiate:TRANsient - Initiates the transient trigger system.

Parameter	Typical Return
(none)	(none)
Initiate the measurement-trigger system: INIT:ACQ	

- It takes a few milliseconds for the instrument to be ready to receive a trigger signal after receiving the INITiate command.
- If a trigger occurs before the trigger system is ready for it, the trigger will be ignored. Check the WTG\_meas bit in the operation status register to know when the instrument is ready.
- Use ABORt commands to return the instrument to Idle.

### INITiate:CONTInuous:TRANsient 0|OFF|1|ON

### INITiate:CONTInuous:TRANsient?

Continuously initiates the transient trigger system. This allows multiple triggers to generate multiple output transients.

Parameter	Typical Return
0 OFF 1 ON, *RST ON	0 or 1
Continually initiates the output trigger system: INIT:CONT:TRAN ON	

- With initiate continuous disabled, the output trigger system must be initiated for each trigger using the INITiate:TRANsient command.
- ABORt:TRANsient does not turn off continuous triggers if INITiate:CONTInuous:TRANsient ON has been programmed. In this case, the trigger system will automatically re-initiate.

## LIST Subsystem N7900 models N6900 Opt 303

List commands program an output sequence of multiple voltage or current settings. A comma-delimited list of up to 512 steps may be programmed. Note that these commands only apply in the presently active priority mode, either voltage priority or current priority.

[SOURce:]

LIST

:COUNT <value> INFinity	Sets the list repeat count.
:CURRent	
[:LEVel] <value>{,<value>}	Specifies the setting for each list step.
:POINts?	Returns the number of list points.
:DWELL <value>{,<value>}	Specifies the dwell time for each list step.
:POINts?	Returns the number of list points.
:STEP ONCE AUTO	Specifies how the list responds to triggers.
:TERMinate	
:LAST 0 OFF 1 ON	Determines the output value when the list terminates.
:TOUtput	
:BOSTep	
[:DATA] <Bool>{,<Bool>}	Generates a trigger out at the Beginning Of Step
:POINts?	Returns the number of list points.
:EOSTep	
[:DATA] <Bool>{,<Bool>}	Generates a trigger out at the End Of Step
:POINts?	Returns the number of list points.
:VOLTag	
[:LEVel] <value>{,<value>}	Specifies the setting for each list step.
:POINts?	Returns the number of list points.

**[SOURce:]LIST:COUNT <value>|MIN|MAX|INFinity**

**[SOURce:]LIST:COUNT? [MIN|MAX]**

Sets the list repeat count. This sets the number of times that a list is executed before it completes. The count range is 1 through 4096. Infinity runs the list continuously.

Parameter	Typical Return
1 – 4096, *RST 1	<count>
Sets the list count to 10: LIST:COUN 10	

**[SOURce:]LIST:CURRent[:LEVel] <value>{,<value>}**  
**[SOURce:]LIST:CURRent[:LEVel]?**  
**[SOURce:]LIST:VOLTage[:LEVel] <value>{,<value**  
**[SOURce:]LIST:VOLTage[:LEVel]?**

Specifies the setting for each list step. Values are specified in either amperes or volts.

Parameter	Typical Return
Voltage: 0 to 102% of rating	<list value 1> ,
Current: -10.2% to 102% of rating	<list value 2> ,
Current with power dissipator: up to -102% to 102% of rating	<list value 3>
Programs a current list. The list contains 3 steps: LIST:CURR 3,2,1	
Programs a voltage list. The list contains 3 steps: LIST:VOLT 20,10,5	

**[SOURce:]LIST:DWELL <value>{,<value>}**  
**[SOURce:]LIST:DWELL?**

Specifies the dwell time for each list step. Dwell time is the time that the output will remain at a specific step. Dwell times can be programmed from 0 through 262.144 seconds with the following resolution:

Range in seconds	Resolution
0 - 0.262144	1 microsecond
0.262144 - 2.62144	10 microseconds
2.62144 - 26.2144	100 microseconds
26.2144 - 262.144	1 millisecond

Parameter	Typical Return
0 - 262.144	<list value 1> , <list value 2> , <list value 3>
Programs a dwell list. The list contains 3 steps: LIST:DWEL 0.2,0.8,1.6	

**[SOURce:]LIST:CURRent:POINTs?**  
**[SOURce:]LIST:DWELL:POINTs?**  
**[SOURce:]LIST:VOLTage:POINTs?**  
**[SOURce:]LIST:TOUTput:BOStep:POINTs?**  
**[SOURce:]LIST:TOUTput:EOStep:POINTs?**

Returns the number of list points. Points are the same as steps. The queries do not return the point values.

Parameter	Typical Return
(none)	<points>
Returns the number of points in the dwell list: LIST:DWEL:POIN?	

**[SOURce:]LIST:STEP ONCE|AUTO**  
**[SOURce:]LIST:STEP?**

Specifies how the list responds to triggers. **ONCE** causes the output to remain at the present step until a trigger advances it to the next step. Triggers that arrive during the dwell time are ignored. **AUTO** causes the output to automatically advance to each step, after the receipt of an initial starting trigger. Steps are paced by the dwell list. As each dwell time elapses, the next step is immediately output.

Parameter	Typical Return
ONCE AUTO, *RST AUTO	ONCE or AUTO
Specifies the list steps to be paced by trigger signals: LIST:STEP ONCE	

**[SOURce:]LIST:TERMinate:LAST 0|OFF|1|ON**  
**[SOURce:]LIST:TERMinate:LAST?**

Determines the output value when the list terminates. When ON (1), the output voltage or current remains at the last list step. The value of the last voltage or current list step becomes the IMMEDIATE value when the list completes. When OFF (0), and also when the list is aborted, the output returns to the settings that were in effect before the list started.

Parameter	Typical Return
0 OFF 1 ON, *RST OFF	0 or 1
Terminate with the output at the last step value: LIST:TERM:LAST ON	

**[SOURce:]LIST:TOUTput:BOSTep[:DATA] 0|OFF|1|ON {,0|OFF|1|ON }**  
**[SOURce:]LIST:TOUTput:BOSTep[:DATA]?**  
**[SOURce:]LIST:TOUTput:EOSTep[:DATA] 0|OFF|1|ON {,0|OFF|1|ON }**  
**[SOURce:]LIST:TOUTput:EOSTep[:DATA]?**

Specifies which list steps generate a trigger signal at the beginning of step (BOSTep) or end of step (EOSTep). A trigger is only generated when the state is set to ON. The trigger signal can be used as a trigger source for measurements and transients of other units, and for digital port pins configured as trigger outputs.

Parameter	Typical Return
0 OFF 1 ON	0 or 1
To generate triggers at the beginning of the second step of a 3-step list: LIST:TOUT:BOST OFF,ON,OFF	

**LXI Command****LXI:IDENTify[:STATe] 0|OFF|1|ON****LXI:IDENTify[:STATe]?**

Turns the front panel LXI identify indicator on or off. When turned on, the "LAN" status indicator on the front panel blinks on and off to identify the instrument that is being addressed.

Parameter	Typical Return
0 OFF 1 ON, *RST OFF	0 or 1
To blink the front panel LXI indicator: LXI:IDENT ON	

## MEASure Subsystem

Measure commands measure the output voltage or current. They trigger the acquisition of new data before returning the reading. Measurements are performed by digitizing the instantaneous output voltage or current for a specified measurement time, storing the results in a buffer, and calculating the value for the specified measurement type.

### MEASure

#### [ :SCALar ]

##### :CURRent

- [ :DC ]? Takes a measurement; returns the averaged current.
- :ACDC? Takes a measurement; returns the RMS current (AC + DC).
- :HIGH? Takes a measurement; returns the High level of a current pulse.
- :LOW? Takes a measurement; returns the Low level of a current pulse.
- :MAXimum? Takes a measurement; returns the maximum current.
- :MINimum? Takes a measurement; returns the minimum current.

##### :POWer

- [ :DC ]? Takes a measurement; returns the averaged power.
- :MAXimum? Takes a measurement; returns the maximum power.
- :MINimum? Takes a measurement; returns the minimum power.

##### :VOLTage

- [ :DC ]? Takes a measurement; returns the averaged voltage.
- :ACDC? Takes a measurement; returns the RMS voltage (AC + DC).
- :HIGH? Takes a measurement; returns the High level of a voltage pulse.
- :LOW? Takes a measurement; returns the Low level of a voltage pulse.
- :MAXimum? Takes a measurement; returns the maximum voltage.
- :MINimum? Takes a measurement; returns the minimum voltage.

#### :ARRAY

##### :CURRent

- [ :DC ]? Takes a measurement; returns the instantaneous current.

##### :POWer

- [ :DC ]? Takes a measurement; returns the instantaneous power.

##### :VOLTage

- [ :DC ]? Takes a measurement; returns the instantaneous voltage.

**MEASure[:SCALar]:CURRent[:DC]?**

**MEASure[:SCALar]:VOLTage[:DC]?**

**MEASure[:SCALar]:POWer[:DC]?**

Initiates, triggers, and returns the averaged output measurement. Values returned are either in amperes, volts, or watts.

Parameter	Typical Return
(none)	<DC value>
Returns the measured DC current MEAS:CURRE?	
Returns the measured DC voltage MEAS:VOLT?	
Returns the measured DC power MEAS:POW?	

**MEASure[:SCALar]:CURRent:ACDC?****MEASure[:SCALar]:VOLTage:ACDC?**

Initiates, triggers, and returns the total RMS measurement (AC + DC). Values returned are either in amperes, or volts.

Parameter	Typical Return
(none)	<ACDC value>
Returns the measured RMS voltage MEAS:VOLT:ACDC?	

**MEASure[:SCALar]:CURRent:HIGH?****MEASure[:SCALar]:VOLTage:HIGH?**

Initiates, triggers, and returns the High level of a pulse waveform. Values returned are either in amperes, or volts. See [Measurement Types](#).

Parameter	Typical Return
(none)	<HIGH value>
Returns the measured high level current MEAS:CURRE:HIGH?	

**MEASure[:SCALar]:CURRent:LOW?****MEASure[:SCALar]:VOLTage:LOW?**

Initiates, triggers, and returns the Low level of a pulse waveform. Values returned are either in amperes, or volts. See [Measurement Types](#).

Parameter	Typical Return
(none)	<LOW value>
Returns the measured low level voltage MEAS:VOLT:LOW?	

**MEASure[:SCALar]:CURRent:MAXimum?**  
**MEASure[:SCALar]:VOLTage:MAXimum?**  
**MEASure[:SCALar]:POWer:MAXimum?**  
**MEASure[:SCALar]:CURRent:MINimum?**  
**MEASure[:SCALar]:VOLTage:MINimum?**  
**MEASure[:SCALar]:POWer:Minimum?**

Initiates, triggers, and returns the maximum or minimum values of a measurement. Values returned are either in amperes, volts, or watts.

Parameter	Typical Return
(none)	<MIN value>, <MAX value>
Returns the measured maximum current <code>MEAS:CURR:MAX?</code>	
Returns the measured maximum voltage <code>MEAS:VOLT:MAX?</code>	
Returns the measured minimum power <code>MEAS:POW:MIN?</code>	

- `MEAS:POW:MIN?` and `MEAS:POW:MAX?` are only available on units with firmware revisions A.02.01.1256 and B.02.01.1256 and up. See [Firmware Update](#).

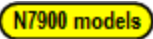
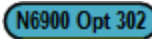
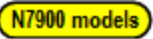
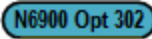
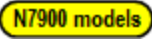
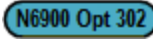
**MEASure:ARRay:CURRent[:DC]?  **  
**MEASure:ARRay:VOLTage[:DC]?  **  
**MEASure:ARRay:POWer[:DC]?  **

Initiates and triggers a measurement; returns a list of the digitized output measurement samples. Values returned are either in amperes, volts, or watts.

The return format depends on the settings of the `FORMat:BORDER` and `FORMat[:DATA]` commands. When the data format is set to ASCII, returned values are comma separated. When the data format is set to REAL, data is returned as single precision floating point values in definite length arbitrary block response format.

Parameter	Typical Return
(none)	<value> [, <value>] or <Block>
Returns the current array <code>MEAS:ARR:CURR?</code>	
Returns the voltage array <code>MEAS:ARR:VOLT?</code>	
Returns the power array <code>MEAS:ARR:POW?</code>	

## OUTPut Subsystem

The Output subsystem controls the output state, power-on, protection, and relay functions.

### OUTPut

<pre>[ :STATe] 0 OFF 1 ON</pre>	Enables or disables the output.
<pre>  :COUPlE</pre>	
<pre>    [ :STATe] 0 OFF 1 ON</pre>	Enables or disables output coupling.
<pre>    :DOFFset &lt;value&gt;</pre>	Sets a delay offset to synchronize coupled output state changes.
<pre>  :MAX</pre>	
<pre>    :DOFFset?</pre>	Returns the delay offset required for this instrument.
<pre>  :OFF</pre>	
<pre>    :SOURce EXPReSSion&lt;1-8&gt; NONE</pre>	Sets the off-couple signal source to an expression.
<pre>  :ON</pre>	
<pre>    :SOURce EXPReSSion&lt;1-8&gt; NONE</pre>	Sets the on-couple signal source to an expression.
<pre>  :DELay</pre>	
<pre>    :FALL &lt;value&gt;</pre>	Sets the output turn-off sequence delay.
<pre>    :RISE &lt;value&gt;</pre>	Sets the output turn-on sequence delay.
<pre>:INHibit</pre>	
<pre>  :MODE LATChing LIVE OFF</pre>	Sets the operating mode of the remote inhibit digital pin.
<pre>:PON</pre>	
<pre>  :STATe RST RCLD</pre>	Sets the output power-on state.
<pre>:PROTection</pre>	
<pre>  :CLEar</pre>	Resets the latched protection.
<pre>  :MODE</pre>	Sets the turn-off behavior for all protection conditions.
<pre>:TEMPerature</pre>	
<pre>  :MARGin?</pre>	Returns the margin remaining before the over-temperature trips.
<pre>:USER</pre>	
<pre>  [ :STATe] 0 OFF 1 ON</pre>	Enables or disables the user-defined protection.
<pre>  :SOURce EXPReSSion&lt;1-8&gt; NONE</pre>	Sets the user-defined protection source to an expression.
<pre>:WDOG</pre>	
<pre>  [ :STATe] 0 OFF 1 ON</pre>	Enables or disables the I/O watchdog timer.
<pre>  :DELay &lt;value&gt;</pre>	Sets the watchdog delay time.
<pre>:RELay</pre>	
<pre>  :LOCK</pre>	
<pre>    [ :STATe] 0 OFF 1 ON</pre>	Enables or disables the locked-closed state of the output relays.
<pre>  :POLarity NORMAl REVerse</pre>	Sets the polarity of the output relays.
<pre>  :ENABle 0 OFF 1 ON</pre>	Enables or disables the polarity reversal function.

## OUTPut[:STATe] 0|OFF|1|ON OUTPut[STATe]?

Enables or disables the output. The state of a disabled output is a condition of zero output voltage and zero source current. If output and sense relays are installed, the relays will open when the output is disabled and close when the output is enabled.

Parameter	Typical Return
0 OFF 1 ON, *RST OFF	0 or 1
Turns the output off: <code>OUTP OFF</code>	

- When output is enabled, the front-panel status indicator changes from **OFF** to indicate the operating status of the instrument (**CV**, **CC**, etc.).
- Separate delays can be programmed for the off-to-on and the on-to-off transition using `OUTPut:DELAy:RISE` and `OUTPut:DELAy:FALL`.
- Because of internal circuit start-up procedures and any installed relay options, `OUTPut ON` may take between 12 and 38 milliseconds to complete its function in voltage priority mode, and between 14 and 46 milliseconds in current priority mode.

## OUTPut[:STATe]:COUPlE[:STATe] 0|OFF|1|ON OUTPut[:STATe]:COUPlE[:STATe]?

Enables or disables output coupling. Output coupling allows the outputs of multiple instruments to turn on and off sequentially according to their specified `OUTPut:DELAy:RISE` and `OUTPut:DELAy:FALL` programming delays. This parameter is saved in non-volatile memory.

Parameter	Typical Return
0 OFF 1 ON	0 or 1
Turns the output coupling state on: <code>OUTP:COUP ON</code>	

- You must connect and configure the `ONCouple` and `OFFCouple` digital connector pins of all synchronized instruments as described in the **Output Couple Control** section.
- Because some power supplies have different minimum delay offsets, you must also specify a common delay offset for all of the synchronized units. This value must be the largest delay offset of the synchronized group. Use `OUTPut:COUPlE:MAX:DOFFset?` to query the delay offset for each unit. The largest value returned must be specified as the common delay offset for each unit.

## OUTPut[:STATe]:COUPlE:DOFFset <value>|MIN|MAX OUTPut[:STATe]:COUPlE:DOFFset? [MIN|MAX]

Sets a delay offset to synchronize coupled output state changes. Units are in seconds. Setting this time to the maximum delay offset specified for any instrument that is being coupled will cause all coupled outputs to synchronize to the turn-on times specified by `OUTPut:DELAy:RISE`. This parameter is saved in non-volatile memory.

Parameter	Typical Return
0 to 1.023	<delay value>
Specifies a delay of 60 milliseconds: <code>OUTP:COUP:DOFF 0.06</code>	

### **OUTPut[:STATe]:COUPle:MAX:DOFFset?**

Returns the delay offset required for this instrument. As a minimum, the `OUTPut:COUPle:DElay:OFFSet` value must be set to the maximum delay offset returned for any coupled output.

Parameter	Typical Return
(none)	<offset value>
Returns the maximum delay offset: <code>OUTP:COUP:MAX:DOFF?</code>	

### **OUTPut[:STATe]:COUPle:OFF:SOURce EXPReSSion<1-8>**

#### **OUTPut[:STATe]:COUPle:OFF:SOURce?**

### **OUTPut[:STATe]:COUPle:ON:SOURce EXPReSSion<1-8>**

#### **OUTPut[:STATe]:COUPle:ON:SOURce?**

Sets the source that drives the `OFFCouple` and `ONCouple` signals to an expression. The output state changes when the selected source transitions from false to true.

Parameter	Typical Return
EXPReSSion<1-8>	EXPR<1-8>
Sets the <code>OFFCouple</code> source to an expression: <code>OUTP:COUP:OFF:SOUR EXPR1</code>	

### **OUTPut[:STATe]:DElay:FALL <value>|MIN|MAX**

#### **OUTPut[:STATe]:DElay:FALL? [MIN|MAX]**

### **OUTPut[:STATe]:DElay:RISE <value>|MIN|MAX**

#### **OUTPut[:STATe]:DElay:RISE? [MIN|MAX]**

Specifies the delay in seconds that the instrument waits before turning the output on (rise) or off (fall). This allows multiple instruments to turn on or off in sequence. The output will not turn on or off until its delay time has elapsed. This command affects on-to-off state transitions. It does NOT affect transitions to off caused by protection functions. Delay times can be programmed with the following resolution:

Range in seconds	Resolution	Range in seconds	Resolution
0 to 1.023E-4	100 nanoseconds	1.03E-1 to 1.023E+0	1 millisecond
1.03E-4 to 1.023E-3	1 microsecond	1.03E+0 to 1.023E+1	10 milliseconds
1.03E-3 to 1.023E-2	10 microseconds	1.03E+1 to 1.023E+2	100 milliseconds
1.03E-2 to 1.023E-1	100 microseconds	1.03E+2 to 1.023E+3	1 second

Note that both Rise and Fall commands use the same resolution; which is determined by whichever delay time (fall or rise) is the longest.

Parameter	Typical Return
0 - 1023, *RST 0	<delay value>
Sets a delay of 0.5 s before turning the output on: <code>OUTP:DEL:RISE 0.5</code>	

- Each APS model exhibits a minimum delay offset that applies from the time that a command to turn on the output is received until the output actually turns on. If you specify a turn-on delay, this delay will be added to the minimum delay offset, resulting in a turn-on delay that is actually longer than the one you programmed.
- Use `OUTput:COUPlE:MAX:DOFFset?` to query the delay offset that is required for each instrument.

### **OUTPut:INHibit:MODE LATChing|LIVE|OFF** **OUTPut:INHibit:MODE?**

Sets the operating mode of the remote inhibit digital pin. The inhibit function shuts down the output in response to an external signal on the Inhibit input pin. The Inhibit mode is stored in non-volatile memory. See [Programming the Digital Port](#).

**LATChing** - a logic-true signal on the Inhibit input causes the output state to latch OFF. The output remains disabled until the Inhibit input is returned to logic-false and the latched INH status bit is cleared by sending the `OUTPut:PROTection:CLEar` command or a protection clear command from the front panel.

**LIVE** - allows the enabled output to follow the state of the Inhibit input. When the Inhibit input is true, the output is disabled. When the Inhibit input is false, the output is re-enabled.

**OFF** - The Inhibit input is ignored.

Parameter	Typical Return
LATChing LIVE OFF	LATC, LIVE, or OFF
Sets the Inhibit Input to Live mode: <code>OUTP:INH:MODE LIVE</code>	

### **OUTPut:PON:STATe RST|RCL0** **OUTPut:PON:STATe?**

Sets the output power-on state. This determines whether the power-on state is set to the \*RST state (RST) or the state stored in memory location 0 (RCL0). Instrument states can be stored using the \*SAV command. This parameter is saved in non-volatile memory.

Parameter	Typical Return
RST RCL0	RST or RCL0
Sets the power-on state to the *RST state: <code>OUTP:PON:STAT RST</code>	

- If the power-on state is set to 0 with no state stored, a self-test error "file not found; 0 state" is generated and the instrument is set to the \*RST state.

### OUTPut:PROTection:CLEAr

Resets the latched protection. This clears the latched protection status that disables the output when a protection condition occurs (see [Programming Output Protection](#)).

Parameter	Typical Return
(none)	(none)
Clears the latched protection status: <code>OUTP:PROT:CLE</code>	

- All conditions that generate the fault must be removed before the latched status can be cleared. The output is restored to the state it was in before the fault condition occurred.
- If a protection shutdown occurs during an output list, the list continues running even though the output is disabled. When the protection status is cleared and the output becomes enabled again, the output will be set to the values of the step that the list is presently at.

### OUTPut:PROTection:MODE HIGHZ|LOWZ

#### OUTPut:PROTection:MODE?

Selects the turn-off behavior for all protection conditions as follows (see [Protection Shutdown Behavior](#)):

**High Impedance** - the output is disconnected without actively sinking current. Without active current sinking, output energy will take longer to dissipate - as downprogramming is solely determined by the unit's passive internal network.

**Low Impedance** - the output voltage is programmed to zero, then disconnected. Maximum negative current sinking occurs for 2 ms during the turn-off transition.

Parameter	Typical Return
HIGHZ LOWZ, *RST LOWZ	HIGHZ or LOWZ
Sets protection behavior to High impedance: <code>OUTP:PROT:MODE HIGHZ</code>	

### OUTPut:PROTection:TEMPerature:MARGin?

Returns the minimum difference between the internal temperature sensors and the over-temperature trip level. The margin is returned in degrees Celsius.

Parameter	Typical Return
(none)	<margin value>
Returns the temperature margin: <code>OUTP:PROT:TEMP:MARG?</code>	

**OUTPut:PROTection:USER[:STATe] 0|OFF|1|ON**  
**OUTPut:PROTection:USER[:STATe]?**

Enables or disables the user-defined protection.

Parameter	Typical Return
0 OFF 1 ON, *RST OFF	0 or 1
Enables the user-defined protection: <code>OUTP:PROT:USER ON</code>	

**OUTPut:PROTection:USER:SOURce EXPReSSion<1-8>|NONE**  
**OUTPut:PROTection:USER:SOURce?**

Sets the user-defined protection source to an expression. When an expression is specified, the output is disabled if the expression is true. See [Programming Output Protection](#).

Parameter	Typical Return
EXPRession<1-8> NONE, *RST NONE	EXPR<1-8>
Sets the user protect source to an expression: <code>OUTP:PROT:USER:SOUR EXPR1</code>	

**OUTPut:PROTection:WDOG[:STATe] 0|OFF|1|ON**  
**OUTPut:PROTection:WDOG[:STATe]?**

Enables or disables the I/O watchdog timer. When enabled, the output will be disabled if there is no I/O activity on any remote interface within the time specified by `OUTput:PROTection:WDOG:DElay`. The output is latched off but the programmed output state is not changed.

Parameter	Typical Return
0 OFF 1 ON, *RST OFF	0 or 1
Enables the watchdog timer protection: <code>OUTP:PROT:WDOG ON</code>	

**OUTPut:PROTection:WDOG:DElay <value>|MIN|MAX**  
**OUTPut:PROTection:WDOG:DElay? [MIN|MAX]**

Sets the watchdog delay time. When the watchdog timer is enabled, the output is disabled if there is no SCPI I/O activity on any remote interface (USB, LAN, GPIB) within the delay time. The watchdog timer function is NOT reset by activity on the front panel - the output will still shut down after the time period has elapsed. Programmed values can range from 1 to 3600 seconds in 1 second increments.

Parameter	Typical Return
0 - 3600, *RST 60	<delay value>seconds
Sets a watchdog delay for 600 seconds: <code>OUTP:PROT:WDOG:DEL 600</code>	

**OUTPut:RELAy:LOCK[:STATe]0|OFF|1|ON** N7900 models N6900 Opt 760 N6900 Opt 761  
**OUTPut:RELAy:LOCK[:STATe]?**

Enables or disables the locked-closed state of the output relays. When locked, the output relays remain closed and do not change with the output state. This improves the output response time for applications that do not require a physical output disconnect. This parameter is saved in non-volatile memory.

Parameter	Typical Return
0 OFF 1 ON	0 or 1
Locks the output relays closed: <code>OUTP:REL:LOCK ON</code>	

**OUTPut:RELAy:POLArity NORMAl|REVerse** N7900 models N6900 Opt 760  
**OUTPut:RELAy:POLArity?**

Sets the polarity of the output relays. Polarity reversal affects both the output and the sense terminals. **Normal** causes the output polarity to be the same as the output connector labeling. **Reverse** causes the output polarity to be the reverse of the output connector labeling. This briefly turns the output off while the output and sense terminal polarities are switched.

Parameter	Typical Return
NORMAl REVerse, *RST NORMAl	NORM or REV
Sets the output polarity to Reverse: <code>OUTP:REL:POL REV</code>	

**OUTPut:RELAy:POLArity:ENABle 0|OFF|1|ON** N7900 models N6900 Opt 760  
**OUTPut:RELAy:POLArity:ENABle?**

Enables or disables the polarity reversal function. This prevents accidental output polarity reversal. This parameter is saved in non-volatile memory.

Parameter	Typical Return
0 OFF 1 ON	0 or 1
Disables the polarity reversal commands: <code>OUTP:REL:POL:ENAB OFF</code>	

**POWer Query****[SOURce:]POWer:LIMit? [MIN|MAX]**

Returns the output power limit of the instrument.

AC mains circuits rated at 100-120 VAC cannot supply enough current to power either the 1 kW or the 2 kW models when operated at their full rated output power. Use this query to return the maximum output power available when connected to 100-120 VAC mains. When the maximum available power limit is exceeded, the instrument turns off the output and sets the CP+ status bit.

Parameter	Typical Return
(none)	<power limit>
Query the power limit: POW:LIM?	

## RESistance Subsystem

Resistance commands program the output resistance.

These commands are superseded by [SOURce:]VOLTage:RESistance[:LEVel][:IMMEDIATE][:AMPLitude] and [SOURce:]VOLTage:RESistance:STATE in later versions of the firmware (refer to [Firmware Updates](#)). The following commands will be accepted, but the new ones are recommended for new applications.

**[SOURce:]RESistance[:LEVel][:IMMEDIATE][:AMPLitude] <value>|MIN|MAX**  
**[SOURce:]RESistance[:LEVel][:IMMEDIATE][:AMPLitude]? [MIN|MAX]**

Sets the output resistance level. Units are in ohms. Refer to [Set the Output Resistance](#) for the model-specific resistance programming ranges.

Parameter	Typical Return
0 to 6.4 $\Omega$ (model dependent)   MIN   MAX *RST 0,	0
Specifies an output resistance of 0.5 ohms: RES 0.5	

**[SOURce:]RESistance:STATE 0|OFF|1|ON**  
**[SOURce:]RESistance:STATE?**

Enables or disables output resistance programming.

Parameter	Typical Return
0 OFF 1 ON, *RST OFF	0 or 1
Turns resistance programming on: RES:STAT ON	

## SENSe Subsystem

Sense commands control the current measurement ranges and window as well as the data acquisition sequence.

### SENSe

:AHOuR	
:RESet	Resets the amp-hour or watt-hour measurement to zero.
:BBR	
:PERiod <value>	Sets the recording period of the black box recorder in seconds.
:CURRent	
[:DC]	
:RANGe	
[:UPPer] <value>	Selects a DC current measurement range.
:AUTO 0 OFF 1 ON	Enables or disables seamless measurement auto ranging.
:ELOG	
:CURRent	
[:DC]	
:RANge	
[:UPPer] <value>	Selects the Elog current measurement range.
:AUTO 0 OFF 1 ON	Enables or disables Elog seamless measurement autoranging.
:FUNctIon	
:CURRent 0 OFF 1 ON	Enables/disables current data logging.
:MINMax 0 OFF 1 ON	Enables/disables min/max current data logging.
:VOLTage 0 OFF 1 ON	Enables/disables voltage data logging.
:MINMax 0 OFF 1 ON	Enables/disables min/max voltage data logging.
:PERiod <value>	Sets the integration time of an Elog measurement.
:FAULt	
:STATe 0 OFF 1 ON	Enables or disables remote sense fault detection.
:SWEep	
:NPLCycles <value>	Sets the measurement time in number of power line cycles.
:OFFSet	
:POINts <value>	Defines the offset in a data sweep for triggered measurements.
:POINts <value>	Defines the number of points in a measurement.
:TINterval <value>	Defines the time period between measurement samples.
:THReshold<1 2 3 4>	
:AHOuR	
[:LEVel] <value>	Sets the amp-hour level for comparator 1,2,3, or 4.
:CURRent	
[:LEVel] <value>	Sets the current level for comparator 1,2,3, or 4.
:FUNctIon	Sets the sensing function for comparator 1,2,3, or 4.
VOLT CURR POW AHO WHO	
:OPERation GT LT	Sets the comparison type for comparator 1,2,3, or 4.

<b>:POWer</b>		
[:LEVel] <value>		Sets the power level for comparator 1,2,3, or 4.
<b>:VOLTagE</b>		
[:LEVel] <value>		Sets the voltage level for comparator 1,2,3, or 4.
<b>:WHOUr</b>		
[:LEVel] <value>		Sets the watt-hour level for comparator 1,2,3, or 4.
<b>:WHOUr</b>		
:RESet		Resets the accumulated watt-hour measurement.
<b>:WINDow</b>		
[:TYPE] HANNing RECTangular		Selects the measurement window.

### **SENSe:AHOuR:RESet** **SENSe:WHOUr:RESet**

Resets the amp-hour or watt-hour measurement to zero.

Parameter	Typical Return
(none)	(none)
Resets the amp-hour measurement: <code>SENSe:AHO:RES</code>	

### **SENSe:BBR:PERiod <value>** **SENSe:BBR:PERiod?**

Sets the recording period of the black box recorder in seconds. This parameter is saved in non-volatile memory.

Parameter	Typical Return
0.01   0.1	<period>
Selects 0.01 seconds: <code>SENSe:BBR:PER 0.01</code>	

### **SENSe:CURREnt[:DC]:RANGe[:UPPer] <value>|MIN|MAX** N7900 models N6900 Opt 301 **SENSe:CURREnt[:DC]:RANGe[:UPPer]? [MIN|MAX]**

Selects a DC current measurement range. The value that you enter must be the highest value that you expect to measure. Units are in amperes. The instrument selects the range with the best resolution for the value entered.

Parameter	Typical Return
0 to maximum	<max current>
Selects the 2 A range: <code>SENSe:CURR:RANG 2</code>	

- The MAX query returns the maximum DC current that can be measured on the present range.

**SENSe:CURREnt[:DC]:RANGe:AUTO 0|OFF|1|ON** N7900 models N6900 Opt 301  
**SENSe:CURREnt[:DC]:RANGe:AUTO?**

Enables or disables seamless measurement auto ranging.

Parameter	Typical Return
0 OFF 1 ON, *RST ON	0 or 1
Enable current measurement autoranging: SENS:CURR:RANG:AUTO ON	

**SENSe:ELOG:CURREnt[:DC]:RANGe[:UPPer] <value>|MIN|MAX**  
**SENSe:ELOG:CURREnt[:DC]:RANGe[:UPPer]? [MIN|MAX]** N7900 models N6900 Opt 302

Selects the Elog current measurement range. The value that you enter must be the highest value that you expect to measure. Units are in amperes. The instrument selects the range with the best resolution for the value entered.

Parameter	Typical Return
0 to maximum	<max current>
Selects the 1 A range: SENS:ELOG:CURR:RANG 1	

- The MAX query returns the maximum DC current that can be measured on the present range.

**SENSe:ELOG:CURREnt[:DC]:RANGe:AUTO 0|OFF|1|ON** N7900 models N6900 Opt 302  
**SENSe:ELOG:CURREnt[:DC]:RANGe:AUTO?**

Enables or disables Elog seamless measurement autoranging.

Parameter	Typical Return
0 OFF 1 ON, *RST ON	0 or 1
Enable Elog current autoranging: SENS:ELOG:CURR:RANG:AUTO ON	

**SENSe:ELOG:FUNction:CURREnt 0|OFF|1|ON** N7900 models N6900 Opt 302  
**SENSe:ELOG:FUNction:CURREnt?**

**SENSe:ELOG:FUNction:VOLTage 0|OFF|1|ON** N7900 models N6900 Opt 302  
**SENSe:ELOG:FUNction:VOLTage?**

Enables or disables the Elog current or voltage measurement function.

Parameter	Typical Return
0 OFF 1 ON, *RST OFF	0 or 1
Enables datalog current measurements: SENS:ELOG:FUNC:CURR ON	

**SENSe:ELOG:FUNction:CURRent:MINMax 0|OFF|1|ON** N7900 models N6900 Opt 302  
**SENSe:ELOG:FUNction:CURRent:MINMax?**

**SENSe:ELOG:FUNction:VOLTage:MINMax 0|OFF|1|ON** N7900 models N6900 Opt 302  
**SENSe:ELOG:FUNction:VOLTage:MINMax?**

Enables or disables logging of the minimum and maximum current or voltage values.

Parameter	Typical Return
0 OFF 1 ON, *RST OFF	0 or 1
Enables MIN/MAX logging values: <code>SENSe:ELOG:FUNction:VOLTage:MINMax ON</code>	

**SENSe:ELOG:PERiod <value>|MIN|MAX** N7900 models N6900 Opt 302  
**SENSe:ELOG:PERiod? [MIN|MAX]**

Sets the integration time of an Elog measurement. Although the absolute minimum logging period is 102.4 microseconds, the actual minimum varies as a function of the number of readings that are being logged (see [Integration Period](#)).

Parameter	Typical Return
0.0001024 to 60, *RST MAX	<period>
Specifies a datalog period of 0.01 seconds: <code>SENSe:ELOG:PER 0.01</code>	

**SENSe:FAULT:STATe 0|OFF|1|ON**  
**SENSe:FAULT:STATe?**

Enables or disables remote sense fault detection. This condition is annunciated by the SF status bit.

Parameter	Typical Return
0 OFF 1 ON, *RST ON	0 or 1
Disables remote sense fault detection: <code>SENSe:FAULT:STATe OFF</code>	

**SENSe:SWEEp:NPLCycles <value>|MIN|MAX**  
**SENSe:SWEEp:NPLCycles? [MIN|MAX]**

Sets the measurement time in number of power line cycles. Increasing the number of power line cycles reduces the measurement noise on current and voltage measurements. Changing the NPLC changes the number of points and time interval setting. The number of points in 1 NPLC depends on the line frequency (see [SENSe:SWEEp:POINts](#)).

Parameter	Typical Return
0.0003072 to 1,258,290,000,000, *RST 1	<NPLC value>
Specifies 100 power line cycles: <code>SENSe:SWEEp:NPLC 100</code>	

**SENSe:SWEep:OFFSet:POINts** <value>|MIN|MAX N7900 models N6900 Opt 302  
**SENSe:SWEep:OFFSet:POINts?** [MIN|MAX]

Defines the offset in a data sweep for triggered measurements. Positive values represent the delay after the trigger occurs but before the samples are acquired. Negative values represent data samples taken prior to the trigger.

Parameter	Typical Return
-524,287 to 2,000,000,000, *RST 0	<offset points>
Specifies -2048 offset points: <code>SENSe:SWE:OFFS:POIN -2048</code>	

**SENSe:SWEep:POINts** <value>|MIN|MAX N7900 models N6900 Opt 302  
**SENSe:SWEep:POINts?** [MIN|MAX]

Defines the number of points in a measurement. The number of points depends on the line frequency (50 Hz or 60 Hz). The default number of points result in a measurement of 1 NPLC.

Parameter	Typical Return
1 to 524,288 MIN MAX, *RST 3255 (60 Hz); 3906 (50 Hz)	<points>
Specifies 2048 points: <code>SENSe:SWE:POIN 2048</code>	

**SENSe:SWEep:TINterval** <value>|MIN|MAX N7900 models N6900 Opt 302  
**SENSe:SWEep:TINterval?** [MIN|MAX]

Defines the time period between measurement samples. Units are in seconds. Values are rounded to the nearest 20.48 microsecond increment. Below 20.48 microseconds, values are rounded to the nearest 10.24 or 5.12 microsecond increment respectively.

Parameter	Typical Return
0.00000512 to 40,000, *RST 0.00000512	<time interval>
Specifies an interval of 1 ms between points: <code>SENSe:SWE:TINT 0.001</code>	

**SENSe:THReshold<1|2|3|4>:FUNctIon** AHOuR|CURRent|POWEr|VOLTAge|WHOUr  
**SENSe:THReshold<1|2|3|4>:FUNctIon?**

Sets the sensing function for comparators THR1, THR2, THR3 or THR4.

**AHOuR** selects the amp-hour function.

**CURRent** selects the current function.

**POWEr** selects the power function.

**VOLTAge** selects the voltage function.

**WHOUr** selects the watt-hour function.

Parameter	Typical Return
AHOur CURRent POWer VOLTage WHOur, *RST VOLTage	AHO, CURR, POW, VOLT, or WHO
Selects the power function for comparator 1: SENS:THR1:FUNC POW	

### SENSe:THReshold<1|2|3|4>:OPERation GT|LT SENSe:THReshold<1|2|3|4>:OPERation?

Sets the operation type for comparator 1,2,3 or 4. **GT** (greater than) specifies that the signal will be true if the measurement is greater than the threshold level. **LT** (less than) specifies that the signal will be true if the measurements less than the threshold level.

Parameter	Typical Return
GT LT, *RST GT	GT or LT
Selects the greater than operation for comparator 1: SENS:THR1:OPER GT	

**SENSe:THReshold<1|2|3|4>:AHOur[:LEVel] <value>|MIN|MAX**  
**SENSe:THReshold<1|2|3|4>:AHOur[:LEVel]? [MIN|MAX]**  
**SENSe:THReshold<1|2|3|4>:CURRent[:LEVel] <value>|MIN|MAX**  
**SENSe:THReshold<1|2|3|4>:CURRent[:LEVel]? [MIN|MAX]**  
**SENSe:THReshold<1|2|3|4>:POWer[:LEVel] <value>|MIN|MAX**  
**SENSe:THReshold<1|2|3|4>:POWer[:LEVel]? [MIN|MAX]**  
**SENSe:THReshold<1|2|3|4>:VOLTage[:LEVel] <value>|MIN|MAX**  
**SENSe:THReshold<1|2|3|4>:VOLTage[:LEVel]? [MIN|MAX]**  
**SENSe:THReshold<1|2|3|4>:WHOur[:LEVel] <value>|MIN|MAX**  
**SENSe:THReshold<1|2|3|4>:WHOur[:LEVel]? [MIN|MAX]**

These commands select the threshold level for comparators 1,2,3 or 4. This becomes the qualifying measurement threshold for generating a true signal.

**AHOur** selects the amp-hour level in hours.

**CURRent** selects the current level in amperes.

**POWer** selects the power level in Watts.

**VOLTage** selects the voltage level in volts.

**WHOur** selects the watt-hour threshold level in hours.

Parameter	Typical Return
0 to maximum, *RST 0	<level value>
Selects a 1 watt-hour threshold for comparator 1: SENS:THR1:WHO 1	

**SENSe:WINDow[:TYPE] HANNing|RECTangular** N7900 models N6900 Opt 302  
**SENSe:WINDow[:TYPE]?**

Selects the measurement window. This sets a signal conditioning function used in scalar DC measurement calculations. Neither window function alters the instantaneous voltage or current data returned in the measurement array.

**Hanning** window is a "raised cosine" function. It is a signal conditioning function that reduces errors in DC measurement calculations in the presence of periodic signals such as AC line ripple. This window only works up to 4883 measurement points. The instrument will revert to a rectangular window when the points exceed 4883.

**Rectangular** window returns measurement calculations with no signal conditioning.

Parameter	Typical Return
HANNing RECTangular, *RST RECTangular	RECT or HANN
Specifies a Hanning window function: <code>SENSe:WIND HANN</code>	

## **[SOURce] Subsystem**

The SOURce keyword is optional in many commands that set parameters for a source or output, such as [SOURce:]CURRent <value>.

Because SOURce subsystem commands are often used without the optional SOURce keyword, these commands are listed by their individual subsystems, below:

### **Subsystems and Commands Using the Optional [SOURce:] Keyword**

**ARB**

**CURRent**

**DIGital**

**FUNction**

**LIST**

**POWER:LIMit?**

**RESistance**

**STEP:TOUTput**

**VOLTage**

## STATus Subsystem

Status register programming lets you determine the operating condition of the instrument at any time. The instrument has three groups of status registers; Operation, Questionable, and Standard Event. The Operation and Questionable status groups each consist of the Condition, Enable, and Event registers as well as NTR and PTR filters.

The Status subsystem is also programmed using Common commands. Common commands control additional status functions such as the Service Request Enable and the Status Byte registers. Refer to [Status Tutorial](#) for more information.

### STATus

:OPERation	
[:EVENT]?	Queries the operation event register.
:CONDition?	Queries the operation condition register.
:ENABle <value>	Sets the operation enable register.
:NTRansiton <value>	Sets the Negative transition filter
:PTRansiton <value>	Sets the Positive transition filter
:USER<1 2>	
:SOURce EXPReSSion<1-8> NONE	Selects an expression to drive the user-defined status bits.
:PRESet	Presets all Enable, PTR, and NTR registers.
:QUESTionable<1 2>	
[:EVENT]?	Queries the questionable event register.
:CONDition?	Queries the questionable condition register.
:ENABle <value>	Sets the questionable enable register.
:NTRansiton <value>	Sets the Negative transition filter
:PTRansiton <value>	Sets the Positive transition filter

### STATus:OPERation[:EVENT]

Queries the **event register** for the **Operation Status** group. This is a read-only register, which stores (latches) all events that are passed by the Operation NTR and/or PTR filter. Reading the Operation Status Event register clears it.

Parameter	Typical Return
(none)	<bit value>
Read the operation status event register: STAT:OPER?	

- The value returned is the binary-weighted sum of all bits set in the register. For example, with bit 3 (value 8) and bit 5 (value 32) set (and corresponding bits enabled), the query returns +40.
- \*RST has no effect on this register.

**STATus:OPERation:CONDition?**

Queries the **condition register** for the **Operation Status** group. This is a read-only register, which holds the live (unlatched) operational status of the instrument. Reading the Operation Status Condition register does not clear it.

Parameter	Typical Return
(none)	<bit value>

---

Read the operation status condition register: `STAT:OPER:COND?`

- The value returned is the binary-weighted sum of all bits set in the register. For example, with bit 3 (value 8) and bit 5 (value 32) set (and corresponding bits enabled), the query returns +40.
- The condition register bits reflect the current condition. If a condition goes away, the corresponding bit is cleared.
- \*RST clears this register, other than those bits where the condition still exists after \*RST.

**STATus:OPERation:ENABLE <value>****STATus:OPERation:ENABLE?**

Sets the value of the **enable register** for the **Operation Status** group. The enable register is a mask for enabling specific bits from the Operation Event register to set the OPER (operation summary) bit of the Status Byte register. `STATus:PRESet` clears all bits in the enable register.

Parameter	Typical Return
A decimal value corresponding to the binary-weighted sum of the register's bits.	<bit value>

---

Enable bit 3 and 4 in the enable register: `STAT:OPER:ENAB 24`

- For example, with bit 3 (value 8) and bit 5 (value 32) set (and corresponding bits enabled), the query returns +40.
- \*CLS does not clear the enable register, but does clear the **event register**.

**STATus:OPERation:NTRansition <value>****STATus:OPERation:NTRansition?****STATus:OPERation:PTRansition <value>****STATus:OPERation:PTRansition?**

Sets and queries the value of the **NTR** (Negative-Transition) and **PTR** (Positive-Transition) registers. These registers serve as a polarity filter between the Operation Condition and Operation Event registers.

When a bit in the NTR register is set to 1, then a 1-to-0 transition of the corresponding bit in the Operation Condition register causes that bit in the Operation Event register to be set.

When a bit in the PTR register is set to 1, then a 0-to-1 transition of the corresponding bit in the Operation Condition register causes that bit in the Operation Event register to be set.

STATus:PRESet sets all bits in the PTR registers and clears all bits in the NTR registers.

Parameter	Typical Return
A decimal value corresponding to the binary-weighted sum of the register's bits.	<bit value>
Enable bit 3 and 4 in the NTR register: STAT:OPER:NTR 24 Enable bit 3 and 4 in the PTR register: STAT:OPER:PTR 24	

- If the same bits in both NTR and PTR registers are set to 1, then any transition of that bit at the Operation Condition register sets the corresponding bit in the Operation Event register.
- If the same bits in both NTR and PTR registers are set to 0, then no transition of that bit at the Operation Condition register can set the corresponding bit in the Operation Event register.
- The value returned is the binary-weighted sum of all bits set in the register.

### STATus:OPERation:USER<1|2>:SOURce EXPReSSion<1-8>|NONE STATus:OPERation:USER<1|2>:SOURce?

Maps the specified expression to one of the two user-defined **Operation Status** bits (USER1 or USER2). When the specified expression is true, the selected user status bit will be set.

Parameter	Typical Return
EXPReSSion<1-8> NONE *RST NONE	EXPR<1-8>
Maps a user-defined status bit to an expression: STAT:OPER:USER1:SOUR EXPR1	

### STATus:PRESet

Presets all Enable, PTR, and NTR registers.

Operation register	Questionable register	Preset setting
STAT:OPER:ENAB	STAT:QUES<1 2>:ENAB	all defined bits are disabled
STAT:OPER:NTR	STAT:QUES<1 2>:NTR	all defined bits are disabled
STAT:OPER:PTR	STAT:QUES<1 2>:PTR	all defined bits are enabled

Parameter	Typical Return
(none)	(none)
Preset the Operation and Questionable registers: STAT:PRES	

**STATus:QUESTionable<1|2>[:EVENT]?**

Queries the **event register** for the **Questionable Status** group. This is a read-only register, which stores (latches) all events that are passed by the Operation NTR and/or PTR filter. Reading the Questionable Status Event register clears it.

Parameter	Typical Return
(none)	<bit value>

---

Read questionable status event register #1: STAT:QUES1?

- The value returned is the binary-weighted sum of all bits set in the register. For example, to enable bit 2 (decimal value = 4), bit 4 (decimal value = 16), the corresponding decimal value would be 20 (4 + 16).
- \*RST has no effect on this register.

**STATus:QUESTionable<1|2>:CONDition?**

Queries the **condition register** for the **Questionable Status** group. This is a read-only register, which holds the live (unlatched) operational status of the instrument. Reading the Questionable Status Condition register does not clear it.

Parameter	Typical Return
(none)	<bit value>

---

Read questionable status condition register #1: STAT:QUES1:COND?

- The value returned is the binary-weighted sum of all bits set in the register. For example, to enable bit 2 (decimal value = 4), bit 4 (decimal value = 16), the corresponding decimal value would be 20 (4 + 16).
- The condition register bits reflect the current condition. If a condition goes away, the corresponding bit is cleared.
- \*RST clears this register, other than those bits where the condition still exists after \*RST.

**STATus:QUESTionable<1|2>:ENABLE <value>****STATus:QUESTionable<1|2>:ENABLE?**

Sets the value of the **enable register** for the **Questionable Status** group. The enable register is a mask for enabling specific bits from the Operation Event register to set the QUES (questionable summary) bit of the Status Byte register. STATus:PRESet clears all bits in the enable register.

Parameter	Typical Return
A decimal value corresponding to the binary-weighted sum of the register's bits.	<bit value>

---

Enable bit 2 and 4 in the questionable enable register #1: STAT:QUES1:ENAB 24

- For example, to enable bit 2 (decimal value = 4), bit 4 (decimal value = 16), the corresponding decimal value would be 20 (4 + 16).
- \*CLS does not clear the enable register, but does clear the **event register**.

**STATus:QUESTionable<1|2>:NTRansition <value>**

**STATus:QUESTionable<1|2>:NTRansition?**

**STATus:QUESTionable<1|2>:PTRansition <value>**

**STATus:QUESTionable<1|2>:PTRansition?**

Sets and queries the value of the **NTR** (Negative-Transition) and **PTR** (Positive-Transition) registers. These registers serve as a polarity filter between the Questionable Condition and Questionable Event registers.

When a bit in the NTR register is set to 1, then a 1-to-0 transition of the corresponding bit in the Questionable Condition register causes that bit in the Questionable Event register to be set.

When a bit in the PTR register is set to 1, then a 0-to-1 transition of the corresponding bit in the Questionable Condition register causes that bit in the Questionable Event register to be set.

STATus:PRESet sets all bits in the PTR registers and clears all bits in the NTR registers.

Parameter	Typical Return
A decimal value corresponding to the binary-weighted sum of the register's bits.	<bit value>
Enable bit 3 and 4 in the questionable NTR register #1: STAT:QUES:NTR 24	
Enable bit 3 and 4 in the questionable PTR register #1: STAT:QUES:PTR 24	

- If the same bits in both NTR and PTR registers are set to 1, then any transition of that bit at the Questionable Condition register sets the corresponding bit in the Questionable Event register.
- If the same bits in both NTR and PTR registers are set to 0, then no transition of that bit at the Questionable Condition register can set the corresponding bit in the Questionable Event register.
- The value returned is the binary-weighted sum of all bits set in the register.

**STEP Command****[SOURce:]STEP:TOUTput 0|OFF|1|ON****[SOURce:]STEP:TOUTput?**

Specifies whether a trigger out is generated when a transient step occurs. A trigger is generated when the state is on (true).

Parameter	Typical Return
0 OFF 1 ON, *RST OFF	0 or 1
Sets the step trigger signal to ON: STEP:TOUT ON	

## SYSTem Subsystem

System commands control system functions that are not directly related to output control, measurement, or status functions. Note that IEEE-488 Common commands also control system functions such as self-test, saving and recalling states, and others.

### SYSTem

:BBR	
:EVENT <"string">	Adds an event string into the BBR event log.
:SNAPshot <value>	Captures a data snapshot of the specified length.
:STATus?	Returns the completion status of the snapshot in percent.
:STATe?	Returns true (1) if the Black Box Recorder is logging.
:TIME?	Returns the length of the Black Box Recorder data.
:COMMunicate	
:LAN TCPIP:CONTRol?	Returns the initial socket control connection port number.
:RLState LOCAL REMOte RWLock	Configures the remote/local state of the instrument.
:DATE <yyyy>,<mm>,<dd>	Sets the date of the system clock.
:ERRor?	Reads and clears one error from the error queue.
:LFRequency?	Returns the power-line reference frequency.
:LFRequency	
:MODE AUTO MAN50 MAN60	Specifies automatic or manual line frequency detection.
:PASSword	
:FPANel	
:RESet	Resets the front panel lockout password to zero.
:REBoot	Reboots the instrument to its power-on state.
:SECurity	
:IMMEDIATE	Clears all user memory and reboots the instrument.
:SIGNal	
:DEFine EXPReSSion<1-8>,<"expression">	Defines up to eight signal expressions.
:TEMPerature	
:AMBient?	Returns the temperature at the air inlet.
:TIME <hh>,<mm>,<ss>	Sets the time of the system clock.
:VERSion?	Returns the SCPI version that the instrument complies with.

### SYSTem:BBR:EVENT <"string">

Adds an event string into the BBR event log. The BBR event log has room for 100,000 events. The maximum length of the string is 55 characters. Enclose string parameters in single or double quotes.

Parameter	Typical Return
<"string">String program data.	(none)
Enter a message into the BBR data: SYST:BBR:EVENT "Starting BBR data"	

**SYSTem:BBR:SNAPshot <time>**

Captures a data snapshot of the specified length. The length is specified in seconds. The snapshot captures the most recent data going back from the time the snapshot command is received. The data is stored in an internal file where it can be retrieved with the software application. Subsequent snapshot commands will overwrite the existing snapshot file.

Parameter	Typical Return
1 - 86,400 (with 10 ms period)	(none)
1 - 864,000 (with 100 ms period)	

---

Captures two hours of most recent snapshot data: SYST:BBR:SNAP 7200

**SYSTem:BBR:SNAPshot:STATus?**

Returns the completion status of the snapshot in percent. The snapshot is finished when 100 is returned.

Parameter	Typical Return
(none)	<% complete>

---

Query the BBR snapshot completion: SYST:BBR:SNAP:STAT?

**SYSTem:BBR:STATe?**

Returns true (1) if the Black Box Recorder is logging. Note that the BBR is momentarily stopped when the BBR period is changed, or when the system time is changed.

Parameter	Typical Return
(none)	0 or 1

---

Query the BBR state: SYST:BBR:STAT?

**SYSTem:BBR:TIME?**

Returns the length of the Black Box Recorder data. The value is returned in seconds.

Parameter	Typical Return
(none)	<length>

---

Query the BBR time: SYST:BBR:TIME?

## **SYSTem:COMMunicate:LAN:CONTRol?** **SYSTem:COMMunicate:TCPIP:CONTRol?**

Returns the initial socket control connection port number. This connection is used to send and receive commands and queries. Unlike the data socket, which uses a fixed port number, the control socket port number varies and must be obtained using these queries.

Parameter	Typical Return
(none)	<port #> (0 if sockets not supported)

Query the Control connection port number:  
SYST:COMM:LAN:CONT? or SYST:COMM:TCP:CONT?

## **SYSTem:COMMunicate:RLState LOCAL|REMOte|RWLock** **SYSTem:COMMunicate:RLState?**

Configures the remote/local state of the instrument. Remote and local do the same thing and are included for compatibility with other products. This programmable setting is completely independent from the front panel lock/unlock function.

**LOCAL** sets instrument to front panel control.

**REMOte** sets the instrument to front panel control.

**RWLock** disables the front panel keys. The instrument can only be controlled via the remote interface.

Parameter	Typical Return
LOCAL REMOte RWLock , *RST LOCAL	LOC, REM, or RWL

Sets the remote/local state to remote: SYST:COMM:RLST REM

- The remote/local state is unaffected by \*RST or any SCPI commands other than SYSTem:COMMunicate:RLState.
- The remote/local instrument state can also be set by other interface commands over the GPIB and some other I/O interface.
- When multiple remote programming interfaces are active, the interface with the most recently changed remote/local state determines the instrument's remote/local state.

## **SYSTem:DATE <yyyy>,<mm>,<dd>** **SYSTem:DATE?**

Sets the date of the system clock. Specify the year, month, and day. Setting the date causes the optional BBR logging function to stop and then start using the new date.

Parameter	Typical Return
<yyyy>,<mm>,<dd>	<date>

Sets the date (January 31, 2012): SYST:DATE 2012,01,31

**SYSTem:ERRor?**

Reads and clears one error from the error queue.

Parameter	Typical Return
(none)	<+0,"No error">
Reads and clear first error in error queue: <code>SYST:ERR?</code>	

- The front-panel ERR annunciator turns on when one or more errors are currently stored in the error queue. Error retrieval is first-in-first-out (FIFO), and errors are cleared as you read them. When you have read all errors from the error queue, the ERR annunciator turns off.
- If more than 20 errors have occurred, the last error stored in the queue (the most recent error) is replaced with -350,"Error queue overflow". No additional errors are stored until you remove errors from the queue. If no errors have occurred when you read the error queue, the instrument responds with +0,"No error".
- The error queue is cleared by the \*CLS and when power is cycled. It is not cleared by a \*RST.
- Errors have the following format (the error string may contain up to 255 characters).  
<error code>,<error string>  
For a list of error codes and message strings, see [SCPI Error Messages](#).

**SYSTem:LFRrequency?**

Returns the power-line reference frequency. This determines the integration time used by `SENSe:SWEEp:NPLC` command.

At power-on, if the line frequency mode is set to Auto, the power supply automatically detects the power-line frequency (50 Hz, 60 Hz, or 400 Hz) and uses this value to determine the integration time used. If the detected power line frequency is 400 Hz, the 50 Hz reference value is actually used (a subharmonic of 400 Hz).

If the auto line detect fails because the line is noisy or out of tolerance, it uses a setting of 60 Hz.

Parameter	Typical Return
(none)	50, 60, or 400
Query the power line frequency: <code>SYST:LFR?</code>	

**SYSTem:LFRrequency:MODE AUTO|MAN50|MAN60**  
**SYSTem:LFRrequency:MODE?**

Specifies automatic or manual line frequency detection.

**AUTO** specifies automatic detection.

**MAN50** specifies a setting of 50 Hz.

**MAN60** specifies a setting of 60 Hz. This parameter is saved in non-volatile memory.

Parameter	Typical Return
AUTO MAN50 MAN60	AUTO, MAN50, or MAN60
Sets the line frequency mode to 60 Hz: SYST:LFR:MODE MAN60	

### SYSTem:PASSword:FPANel:RESet

Resets the front panel lockout password to zero. This command does not reset the calibration password.

Parameter	Typical Return
(none)	(none)
Resets the front panel password: SYST:PASS:FPAN:RES	

### SYSTem:REBoot

Reboots the instrument to its power-on state.

Parameter	Typical Return
(none)	(none)
Reboots the instrument: SYST:REB	

### SYSTem:SECurity:IMMEDIATE

Clears all user memory and reboots the instrument. This command is typically used to prepare the instrument for removal from a secure area. It sanitizes all user data. It writes all zeros to flash memory and then performs a chip erase as per manufacturer's data sheet. Identification data (instrument firmware, model number, serial number, MAC address and calibration data) is not erased. After the data is cleared, the instrument is rebooted.

This procedure is not recommended for use in routine applications because of the possibility of unintended loss of data.

Parameter	Typical Return
(none)	(none)
Sanitizes the instrument: SYST:SEC:IMM	

- On units with serial numbers prior to MY59100101, this command does not sanitize the BBR drive (Keysight N7908A). The BBR drive must be removed and destroyed to sanitize the BBR data.

## **SYSTem:SIGNal:DEFine EXPReSSion<1-8>, <"expression">** **SYSTem:SIGNal:DEFine? EXPReSSion<1-8>**

Defines up to eight signal expressions. Refer to [Define Signal Expressions](#) for a complete list of signal sources and operators that are used to "build" each signal expression.

Parameter	Typical Return
EXPReSSion<1-8>	(none)
<"expression">	<"expression">
Defines the first expression to be true when the output is on: SYST:SIGN:DEF EXPR1, "OutpOn"	

Expressions must be enclosed in quotes (") inside SCPI commands. Expressions are case-insensitive. You can enter alpha characters as all caps, all lowercase, or mixed case. Spaces must be included on either side of the Boolean operators And, Or, and Not. Spaces are not required around parentheses.

## **SYSTem:TEMPerature:AMBient?**

Returns the temperature at the air inlet. Values are returned in degrees C.

Parameter	Typical Return
(none)	<"ambient temp">
Return the ambient air temperature: SYST:TEMP:AMB?	

## **SYSTem:TIME <hh>,<mm>,<ss>** **SYSTem:TIME?**

Sets the time of the system clock. Specify hours (0 to 23), minutes (0 to 59), and seconds (0 to 59).

Parameter	Typical Return
<hh>,<mm>,<ss>	<hh,mm,ss>
Set the clock to 8:30 PM: SYST:TIME 20,30,0	

- Setting the time causes the optional BBR logging function to stop and restart using the new time.

## **SYSTem:VERSion?**

Returns the SCPI version that the instrument complies with. Cannot be determined from front panel.

Parameter	Typical Return
(none)	<"YYYY.V">
Return the SCPI version: SYST:VERS?	

- In the return string, YYYY represents the year and V represents the version.

## TRIGger Subsystem

Trigger commands control the transient and acquisition subsystems. Refer to [Trigger Overview](#) for more information.

### TRIGger

<b>:ACQuire</b>		
[:IMMediate]		Generates an immediate trigger.
:CURRent		
[:LEVel] <value>		Sets the triggered level of the output.
:SLOPe POSitive NEGative		Sets the slope of the signal.
:INDices		
[:DATA]?		Returns the indices where triggers were captured.
:COUNT?		Returns the number of triggers captured during the acquisition.
:SOURce <source>		Selects the trigger source for the acquisition system: BUS  CURRent1  EXTernal  EXPRession<1-8>  PIN<1-7>  TRANSient1  VOLTage1
:TOUTput		
[:ENABle] 0 OFF 1 ON		Enables measurement triggers to be sent to a digital port pin.
:VOLTage		
[:LEVel] <value>		Sets the triggered level of the output.
:SLOPe POSitive NEGative		Sets the slope of the signal.
:ARB		
:SOURce <source>		Selects the trigger source for arbitrary waveforms: BUS  EXTernal  IMMediate  EXPRession<1-8>  PIN<1-7>
:ELOG		
[:IMMediate]		Generates an immediate trigger.
:SOURce <source>		Selects the trigger source for external data logging: BUS  EXTernal  IMMediate  PIN<1-7>
:TRANSient		
[:IMMediate]		Generates an immediate trigger.
:SOURce <source>		Selects the trigger source for the transient system: BUS  EXTernal  IMMediate  EXPRession<1-8>  PIN<1-7>

### TRIGger:ACQuire[:IMMediate]

### TRIGger:ELOG[:IMMediate] N7900 models N6900 Opt 302

### TRIGger:TRANSient[:IMMediate]

Generates an immediate trigger. This overrides any selected trigger source. TRIGger:ACQuire triggers the acquisition system. TRIGger:ELOG triggers the external datalogger. TRIGger:TRANSient triggers the transient system.

Parameter	Typical Return
(none)	(none)
Generate a measurement trigger: TRIG:ACQ	

**TRIGger:ACQuire:CURRent[:LEVel] <value>|MIN|MAX**

**TRIGger:ACQuire:CURRent[:LEVel]? [MIN|MAX]**

**TRIGger:ACQuire:VOLTage[:LEVel] <value>|MIN|MAX**

**TRIGger:ACQuire:VOLTage[:LEVel]? [MIN|MAX]**

Sets the triggered level of the output. Applies when the measurement trigger source is set to a level. Values are specified in either amperes or volts. The minimum and maximum values depend on the ratings of the unit.

Parameter	Typical Return
Voltage: 0 to 102% of rating, *RST 0 Current: -10.2% to 102% of rating, *RST 0 Current with power dissipator: up to -102% to 102% of rating	<level value>
Set the triggered current level to 3 A: TRIG:ACQ:CURR 3 Set the triggered voltage level to 50 V: TRIG:ACQ:VOLT 50	

**TRIGger:ACQuire:CURRent:SLOPe POSitive|NEGative**

**TRIGger:ACQuire:CURRent:SLOPe?**

**TRIGger:ACQuire:VOLTage:SLOPe POSitive|NEGative**

**TRIGger:ACQuire:VOLTage:SLOPe?**

Sets the slope of the signal. Applies when the measurement trigger source is set to a level. **POSitive** specifies a rising slope of the output signal. **NEGative** specifies a falling slope of the output signal.

Parameter	Typical Return
POSitive NEGative, *RST POSitive	POS or NEG
Set current slope to negative (falling edge): TRIG:ACQ:CURR:SLOP NEG Set voltage slope to negative (falling edge): TRIG:ACQ:VOLT:SLOP NEG	

**TRIGger:ACQuire:INDices[:DATA]?  **

Returns the indices into the acquired data where triggers were captured during the acquisition. The number of indices returned is the same as the value returned by TRIGger:ACQuire:INDices:COUNT?

Parameter	Typical Return
(none)	<time>
Returns the number of indices: TRIG:ACQ:IND?	

**TRIGger:ACQuire:INDices:COUNT?  **

Returns the number of triggers captured during the acquisition.

Parameter	Typical Return
(none)	<time>
Return the number of triggers: TRIG:ACQ:IND:COUN?	

### TRIGger:ACQuire:TOUTput[:ENABLE] 0|OFF|1|ON TRIGger:ACQuire:TOUTput[:ENABLE]?

Enables measurement triggers to be sent to a digital port pin. The digital port pin must be configured as trigger output before it can be used as a trigger source (see [External Trigger I/O](#)).

Parameter	Typical Return
0 OFF 1 ON, *RST OFF	0 or 1
Enable sending measurement triggers to digital pins: TRIG:ACQ:TOUT ON	

### TRIGger:ACQuire:SOURce <source> TRIGger:ACQuire:SOURce?

Selects the trigger source for the acquisition system:

<b>BUS</b>	Selects a remote interface trigger command.
<b>CURRENT1</b>	Selects an output current level.
<b>EXTERNAL</b>	Selects ALL digital port pins that have been configured as trigger sources.
<b>EXPRESSION&lt;1-8&gt;</b>	Selects a user-defined expression as the trigger source.
<b>PIN&lt;1-7&gt;</b>	Selects a digital port pin configured as a trigger input.
<b>TRANSIENT1</b>	Selects the transient system as the trigger source.
<b>VOLTAGE1</b>	Selects an output voltage level.

Parameter	Typical Return
BUS CURRENT1   EXTERNAL   EXPRESSION<1-8>   PIN<1-7>   TRANSIENT1   VOLTAGE1, *RST BUS	BUS, CURR1, EXT, EXPR<n>, PIN<n>, TRAN1, or VOLT1
Select digital port pin 1 as the measurement trigger source: TRIG:ACQ:SOUR PIN1	

### TRIGger:ARB:SOURce <source> N7900 models N6900 Opt 303 TRIGger:ARB:SOURce?

Selects the trigger source for arbitrary waveforms:

<b>BUS</b>	Selects a remote interface trigger command.
<b>EXTERNAL</b>	Selects ALL digital port pins that have been configured as trigger sources.
<b>EXPRESSION&lt;1-8&gt;</b>	Selects a user-defined expression as the trigger source.
<b>IMMEDIATE</b>	Triggers the transient as soon as it is INITiated.
<b>PIN&lt;1-7&gt;</b>	Selects a digital port pin configured as a trigger input.

Parameter	Typical Return
BUS   EXTERNAL   IMMEDIATE   EXPRESSION<1-8>   PIN<1-7> *RST BUS	BUS, EXT, IMM, EXPR<n>, PIN<n>

---

Select digital port pin 1 as the Arb trigger source: TRIG:ARB:SOUR PIN1

### TRIGGER:ELOG:SOURCE <source> N7900 models N6900 Opt 302

#### TRIGGER:ELOG:SOURCE?

Selects the trigger source for external data logging:

<b>BUS</b>	Selects a remote interface trigger command.
<b>EXTERNAL</b>	Selects ALL digital port pins that have been configured as trigger sources.
<b>IMMEDIATE</b>	Triggers the transient as soon as it is INITIATED.
<b>PIN&lt;1-7&gt;</b>	Selects a digital port pin configured as a trigger input.

Parameter	Typical Return
BUS   EXTERNAL   IMMEDIATE   PIN<1-7> *RST BUS	BUS, EXT, IMM, PIN<n>

---

Select digital port pin 1 as the Elog trigger source: TRIG:ELOG:SOUR PIN1

### TRIGGER:TRANSIENT:SOURCE <source>

#### TRIGGER:TRANSIENT:SOURCE?

Selects the trigger source for the transient system:

<b>BUS</b>	Selects a remote interface trigger command.
<b>EXTERNAL</b>	Selects ALL digital port pins that have been configured as trigger sources.
<b>EXPRESSION&lt;1-8&gt;</b>	Selects a user-defined expression as the trigger source.
<b>IMMEDIATE</b>	Triggers the transient as soon as it is INITIATED.
<b>PIN&lt;1-7&gt;</b>	Selects a digital port pin configured as a trigger input.

Parameter	Typical Return
BUS   EXTERNAL   IMMEDIATE   EXPRESSION<1-8>   PIN<1-7>, *RST BUS	BUS, EXT, IMM, EXPR<n>, PIN<n>

---

Select digital port pin 1 as the transient trigger source: TRIG:TRAN:SOUR PIN1

## VOLTage Subsystem

Voltage commands program the output voltage of the instrument.

[SOURce:]		
VOLTage		
[:LEVel]		
[:IMMediate]		
[:AMPLitude] <value>		Sets the output voltage when in voltage priority mode.
:TRIGgered		
[:AMPLitude] <value>		Sets the triggered output voltage.
:BWIDth LOW HIGH1		Sets the voltage bandwidth. (for backward compatibility)
:LEVel 0 1, <value>		Sets the programming pole frequency.
:RANGe 0 1		Sets the voltage bandwidth.
:LIMit		
[:POSitive]		
[:IMMediate]		
[:AMPLitude] <value>		Sets the voltage limit when in current priority mode.
:MODE FIXed STEP LIST ARB		Sets the transient mode.
:PROTection		
[:LEVel] <value>		Sets the over-voltage protection level.
:RESistance		
[:LEVel]		
[:IMMediate]		
[:AMPLitude] <value>		Sets the output resistance when in voltage priority mode.
:STATe 0 OFF 1 ON		Enables or disables resistance programming in voltage priority mode.
:SLEW		
[:IMMediate] <value> INFinity		Sets the voltage slew rate.
:MAXimum 0 OFF 1 ON		Enables or disables the maximum slew rate override.

**[SOURce:]VOLTage[:LEVel][:IMMediate][:AMPLitude] <value>|MIN|MAX**

**[SOURce:]VOLTage[:LEVel][:IMMediate][:AMPLitude]? [MIN|MAX]**

**[SOURce:]VOLTage[:LEVel]:TRIGgered[:AMPLitude] <value>|MIN|MAX**

**[SOURce:]VOLTage[:LEVel]:TRIGgered[:AMPLitude]? [MIN|MAX]**

Sets the immediate or triggered voltage level when the output is operating in voltage priority mode.

The triggered level is the value that is transferred to the output when an output Step is triggered. Units are in volts. The maximum value depends on the voltage rating of the unit.

Parameter	Typical Return
0.1% to 102% of rating, *RST 0.1% of rating	<voltage level>
Sets the output voltage to 20 V: VOLT 20	

**[SOURce:]VOLTage:BWIDth LOW|HIGH1**  
**[SOURce:]VOLTage:BWIDth?**

**NOTE**

This command is superseded by VOLTage:BWIDh:RANGe in later versions of the firmware. This command will be accepted, but VOLTage:BWIDh:RANGe is recommended for new applications.

Sets the voltage bandwidth. This lets you optimize output response time with capacitive loads.

These compensation modes only apply when the unit is operating in voltage priority mode. **HIGH1** provides maximum up-programming speed as well as the fastest transient response time when the output capacitance is restricted to small values. **LOW** is optimized for stability with a wide range of output capacitors. Refer to **Set the Output Bandwidth** for specific capacitive load limits.

Parameter	Typical Return
LOW HIGH1, *RST HIGH1	HIGH1 or LOW
Sets the voltage bandwidth to Low: VOLT:BWID LOW	

**[SOURce:]VOLTage:BWIDth:LEVel 0|1, <value>|MIN|MAX**  
**[SOURce:]VOLTage:BWIDth:LEVel? 0|1, [MIN|MAX]**

N7900 models

N6900 Opt 303

Sets the programming pole frequency associated with each voltage priority compensation range. The value is in Hertz. The default frequency is optimized for maximum up-programming speed as well as the fastest transient response time. It can be reduced to compensate for output overshoots.

Parameter	Typical Return
0 1, *RST 1	0 or 1
200 - 500,000 for range 0 10000 - 500,00 for range 1	200 or 10,000
Sets bandwidth range 0 to 1 kHz: VOLT:BWID:LEV 0, 1000	

**[SOURce:]VOLTage:BWIDth:RANGe 0|1**  
**[SOURce:]VOLTage:BWIDth:RANGe?**

Sets the voltage bandwidth. This lets you optimize output response time with capacitive loads.

These compensation modes only apply when the unit is operating in voltage priority mode. **1** (high) provides maximum up-programming speed as well as the fastest transient response time when the output capacitance is restricted to small values. **0** (low) is optimized for stability with a wide range of output capacitors. Refer to **Set the Output Bandwidth** for specific capacitive load limits.

Parameter	Typical Return
0 1, *RST 1	0 or 1
Sets the bandwidth range to 0 (low): VOLT:BWID:RANG 0	

**[SOURce:]VOLTage:LIMit[:POSitive][:IMMEDIATE][:AMPLitude] <value>|MIN|MAX**  
**[SOURce:]VOLTage:LIMit[:POSitive][:IMMEDIATE][:AMPLitude]? [MIN|MAX]**

Sets the voltage limit when in current priority mode. Units are in volts.

Parameter	Typical Return
0.1% to 102% of rating, *RST 1% of rating	<voltage limit>
Sets the voltage limit to 20 V: <code>VOLT:LIM 20</code>	

**[SOURce:]VOLTage:MODE FIXed|STEP|LIST|ARB**  
**[SOURce:]VOLTage:MODE?**

Sets the transient mode. This determines what happens to the output voltage when the transient system is initiated and triggered.

**FIXed** keeps the output voltage at its immediate value.

**STEP** steps the output to the triggered level when a trigger occurs.

**LIST** causes the output to follow the list values when a trigger occurs.

**ARB** causes the output to follow the arbitrary waveform values when a trigger occurs.

Parameter	Typical Return
FIXed STEP LIST ARB, *RST FIXed	FIX, STEP, LIST, or ARB
Sets the voltage mode to Step: <code>VOLT:MODE STEP</code>	

**[SOURce:]VOLTage:PROTection[:LEVel] <value>|MIN|MAX**  
**[SOURce:]VOLTage:PROTection[:LEVel]? [MIN|MAX]**

Sets the over-voltage protection level. Units are in volts. If the output voltage exceeds the OVP level, the output is disabled and the Questionable Condition status register OV bit is set.

Parameter	Typical Return
0 to 120% of rating, *RST 120% of rating	<protect level>
Sets the over-voltage protection to 24 V: <code>VOLT:PROT 24</code>	

- An over-voltage condition can be cleared with the `OUTput:PROTection:CLEar` command after the cause of the condition has been removed.

**[SOURce:]VOLTage:RESistance[:LEVel][:IMMEDIATE][:AMPLitude] <value>|MIN|MAX**  
**[SOURce:]VOLTage:RESistance[:LEVel][:IMMEDIATE][:AMPLitude]? [MIN|MAX]**

Sets the output resistance level in voltage in voltage priority mode. Units are in ohms. Refer to [Set the Output Resistance](#) for the model-specific resistance programming ranges.

Parameter	Typical Return
0 to 6.4 $\Omega$ (model dependent) MIN MAX, *RST 0	0
Specifies an output resistance of 0.5 ohms: VOLT:RES 0.5	

**[SOURce:]VOLTage:RESistance:STATe 0|OFF|1|ON**  
**[SOURce:]VOLTage:RESistance:STATe?**

Enables or disables output resistance programming in voltage priority mode.

Parameter	Typical Return
0 OFF 1 ON, *RST OFF	0 or 1
Turns resistance programming on: VOLT:RES:STAT ON	

**[SOURce:]VOLTage:SLEW[:IMMEDIATE] <value>|MIN|MAX|INFinity**  
**[SOURce:]VOLTage:SLEW[:IMMEDIATE]? [MIN|MAX]**

Sets the voltage slew rate. The slew rate is set in volts per second and affects all programmed voltage changes, including those due to the output state turning on or off. The slew rate can be set to any value between 0 and 9.9E+37. For very large values, the slew rate will be limited by the analog performance of the output circuit. The keywords MAX or INFinity set the slew rate to maximum.

Parameter	Typical Return
0 – 9.9E+37, *RST MAX	<max value>
Sets the output slew rate to 5 V per second: VOLT:SLEW 5	

- The query returns the value that was sent, unless the value is less than the minimum slew rate, in which case the minimum value is returned. The resolution of the slew setting is also the minimum value, which can be queried using VOLTage:SLEW? MIN. The exact value varies slightly according to calibration.

**[SOURce:]VOLTage:SLEW:MAXimum 0|OFF|1|ON**  
**[SOURce:]VOLTage:SLEW:MAXimum?**

Enables or disables the maximum slew rate override. When enabled, the slew rate is set to its maximum value. When disabled, the slew rate is set to the immediate value set by the [SOURce:]VOLTage:SLEW command. Use [SOURce:]VOLTage:SLEW? MAX to query the maximum slew rate that was set.

Parameter	Typical Return
0 OFF 1 ON, *RST ON	0 or 1
Enable the maximum slew rate override: VOLT:SLEW:MAX ON	

- The [SOURce:]VOLTage:SLEW:MAX command is coupled to the [SOURce:]VOLTage:SLEW command. If [SOURce:]VOLTage:SLEW sets the rate to MAX or INFINITY, [SOURce:]VOLTage:SLEW:MAX is enabled. If the slew rate is set to any other value, [SOURce:]VOLTage:SLEW:MAX is disabled.

## Status Tutorial

This section provides a detailed description of the individual registers and register groups. The status diagram provides an graphical view of how the status registers and groups are interconnected.

### Status Registers

#### Operation Status Group

#### Questionable Status Group

#### Standard Event Status Group

#### Status Byte Register

#### Error and Output Queues

#### Status Diagram

## Status Registers

The Operation and Questionable status groups use four different types of registers to track qualify, flag, and enable instrument events. The Standard Event group only uses Event and Enable registers.

- A Condition register continuously monitors the state of the instrument. The bits in the condition register are updated in real time and the bits are not latched.
- An PTR/NTR register qualifies the signal that passes to the event register. When a PTR bit is set, signals with positive edge transition pass to the event register. When an NTR bit is set, signals with a negative edge transition pass to the event register. When both bits are set, all signal pass. When neither bits are set, no signals pass.
- An Event register latches transitions that pass through the positive and negative transition registers. When an event bit is set, it remains set until the Event register is read. Reading the Event register clears it.
- An Enable register defines which bits in the event register will be reported to the Status Byte register. You can write to or read from an enable register.

## Operation Status Group

These registers record signals that occur during normal operation. The group consists of a Condition, PTR/NTR, Event, and Enable register. The outputs of the Operation Status register group are logically-ORed into the OPERation summary bit (7) of the Status Byte register. Refer to **Status Registers** for a description of each register. The following table describes the Operation Status register bit assignments.

Bit	Bit Name	Decimal Value	Definition
0	CV	1	Output is in constant voltage
1	CC	2	Output is in constant current
2	OFF	4	Output is programmed off
3	WTG-meas	8	Measurement system is waiting for a trigger
4	WTG-tran	16	Transient system is waiting for a trigger
5	MEAS-active	32	Measurement system is initiated or in progress
6	TRAN-active	64	Transient system is initiated or in progress
7	User1	128	The User1-defined expression is true
8	User2	256	The User2-defined expression is true
9-15	not used	not used	0 is returned

### Questionable Status Group

These two register groups record signals that indicate abnormal operation. The group consists of a Condition, PTR/NTR, Event, and Enable register. The outputs of the Questionable Status group are logically-ORed into the QUESTionable summary bit (3) of the Status Byte register. Refer to **Status Registers** for a description of each register. The following table describes the Questionable1 Status register bit assignments.

Bit	Bit Name	Decimal Value	Definition
0	OV	1	Output is disabled by the over-voltage protection
1	OC	2	Output is disabled by the over-current protection
2	PF	4	Output is disabled by power-fail (low-line or brownout on AC line)
3	CP+	8	Output is disabled by the positive over-power limit
4	OT	16	Output is disabled by the over-temperature protection
5	CP-	32	Output is disabled by the negative over-power limit
6	OV-	64	Output is disabled by a negative OV due to reversed sense leads
7	LIM+	128	Output is in positive voltage or current limit
8	LIM-	256	Output is in negative current limit
9	INH	512	Output is disabled by an external INHibit signal
10	UNR	1024	Output is unregulated

11	PROT	2048	Output is disabled by a watchdog timer protection
12	EDP	4096	Output is disabled by excessive output dynamic protection
13	SF	8192	A sense lead fault has been detected
14,15	not used	not used	0 is returned

The following table describes the Questionable2 assignments.

Bit	Bit Name	Decimal Value	Definition
0	UProt	1	Output is disabled by a user-defined protection signal
1	IPK+	2	Output is in positive peak current limit
2	IPK-	4	Output is in negative peak current limit
3	CSF	8	A current sharing fault has occurred
4-15	not used	not used	0 is returned

## Standard Event Status Group

These registers are programmed by Common commands. The group consists of an Event and Enable register. The Standard Event event register latches events relating to communication status. It is a read-only register that is cleared when read. The Standard Event enable register functions similarly to the enable registers of the Operation and Questionable status groups. Refer to [Status Registers](#) for a description of each register. The following table describes the Standard Event Status register bit assignments.

Bit	Bit Name	Decimal Value	Definition
0	Operation Complete	1	All commands before and including *OPC have been executed.
1	not used	not used	0 is returned
2	Query Error	4	The instrument tried to read the output buffer but it was empty, a new command line was received before a previous query has been read, or both the input and output buffers are full.
3	Device-specific Error	8	A device-specific error, including a self-test error, calibration error or other device-specific error occurred. <a href="#">Error Messages</a>
4	Execution Error	16	An execution error occurred. <a href="#">Error Messages</a>
5	Command	32	A command syntax error occurred. <a href="#">Error Messages</a>
6	not used	not used	0 is returned
7	Power On	128	Power has been cycled since the last time the event register was read or cleared.

## Status Byte Register

This register summarizes the information from all other status groups as defined in the IEEE 488.2 Standard Digital Interface for Programmable Instrumentation. The following table describes the Status Byte register bit assignments.

Bit	Bit Name	Decimal Value	Definition
0	not used	not used	0 is returned
1	not used	not used	0 is returned
2	Error Queue	4	One or more errors in the Error Queue. Use <code>SYSTem:ERRor?</code> to read and delete errors.
3	Questionable Status Summary	8	One or more bits are set in the Questionable Data Register. Bits must be enabled, see <code>STATus:QUEStionable:ENABLE</code> .
4	Message Available	16	Data is available in the instrument's output buffer.
5	Event Status Summary	32	One or more bits are set in the Standard Event Register. Bits must be enabled, see <code>*ESE</code> .
6	Master Status Summary	64	One or more bits are set in the Status Byte Register and may generate a Request for Service. Bits must be enabled, see <code>*SRE</code> .
7	Operation Status Summary	128	One or more bits are set in the Operation Status Register. Bits must be enabled, see <code>STATus:OPERation:ENABLE</code> .

### Master Status Summary and Request for Service Bits

MSS is a real-time (unlatched) summary of all Status Byte register bits that are enabled by the Service Request Enable register. MSS is set whenever the instrument has one or more reasons for requesting service. `*STB?` reads the MSS in bit position 6 of the response but does not clear any of the bits in the Status Byte register.

The RQS bit is a latched version of the MSS bit. Whenever the instrument requests service, it sets the SRQ interrupt line true and latches RQS into bit 6 of the Status Byte register. When the controller does a serial poll, RQS is cleared inside the register and returned in bit position 6 of the response. The remaining bits of the Status Byte register are not disturbed.

### Error and Output Queues

The Error Queue is a first-in, first-out (FIFO) data register that stores numerical and textual description of an error or event. Error messages are stored until they are read with `SYSTem:ERRor?` If the queue overflows, the last error/event in the queue is replaced with error -350,"Queue overflow".

The Output Queue is a first-in, first-out (FIFO) data register that stores instrument-to-controller messages until the controller reads them. Whenever the queue holds messages, it sets the MAV bit (4) of the Status Byte register.

## Status Diagram

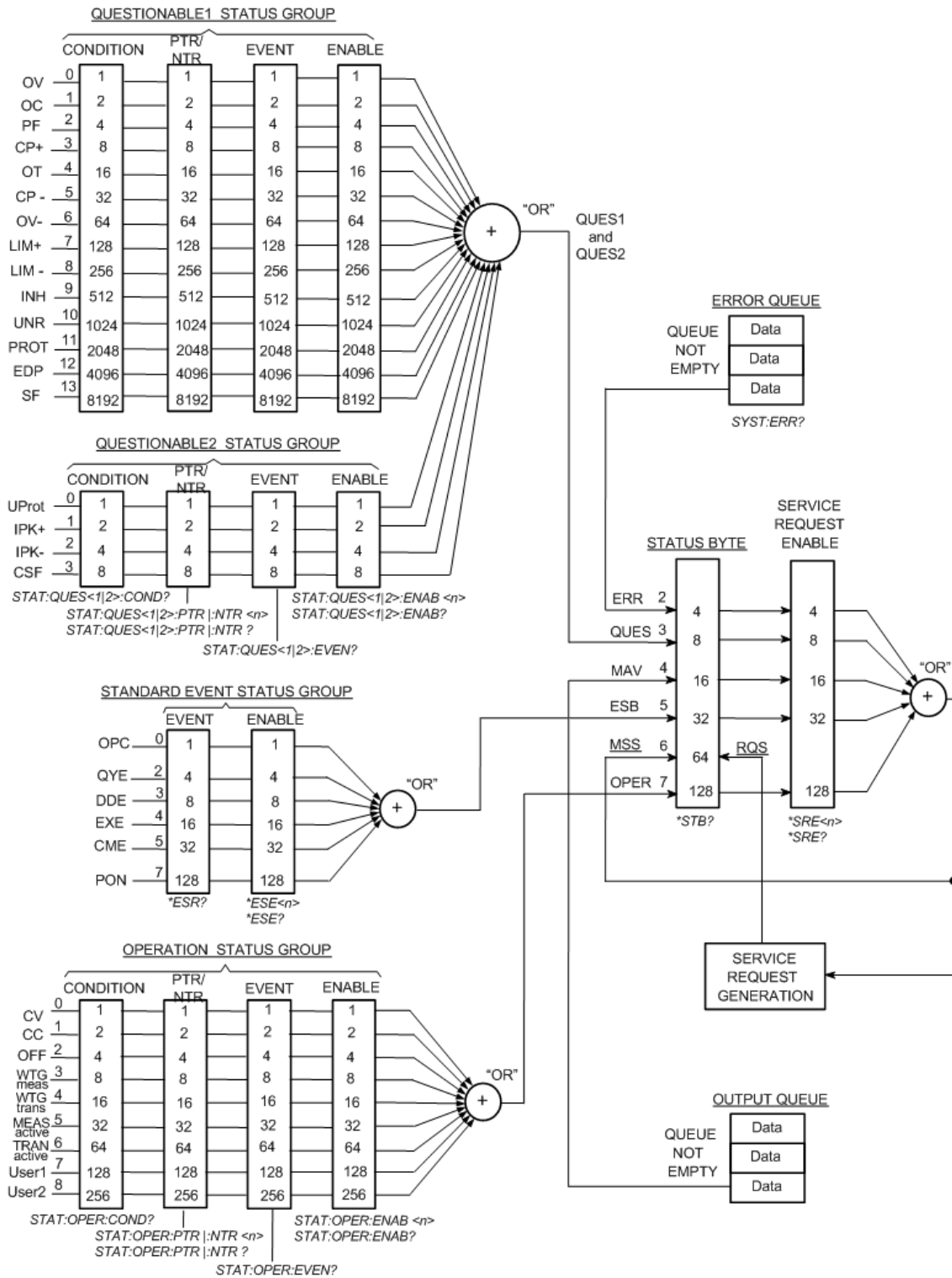

## Trigger Tutorial

The APS trigger system is a flexible, multi-purpose system that controls the operation of the instrument to suit a variety of user-defined applications. The trigger diagram below provides an graphical view of how the trigger sources and destinations are interconnected.

### Trigger Sources

### Trigger Destinations

### Trigger Diagram

## Trigger Sources

The following table describes the available trigger sources, which are shown on the left of the trigger diagram. Note that not all trigger sources can be applied to every trigger subsystem.

Source	Description
BUS	Enables GPIB device triggers, *TRG, or <GET> (Group Execute Trigger).
CURRent1	Selects an output current level.
EXPRession<1-8>	Selects one of eight user-defined expressions. See <a href="#">Using Expression Signal Routing</a> .
IMMEDIATE	Triggers the transient as soon as it is INITiated.
PIN<1-7> EXTernal	Selects a digital port pin configured as a trigger input. EXTernal selects ALL connector pins that have been configured as trigger inputs.
TRANSient1	Selects the transient system as the trigger source.
TRIG:ACQ:IMM	Triggers the acquisition immediately.
TRIG:ELOG:IMM	Triggers the Elog immediately.
TRIG:TRAN:IMM	Triggers the transient immediately.
VOLTage1	Selects an output voltage level.

## Trigger Destinations

The following table describes the trigger system destinations. Note that the trigger system, when used in conjunction with user-defined signal routing, can generate a number of power supply actions that can control specific applications.

Destination	Description
Digital Pin	Sends the trigger output signal to the designated digital output pin. See <a href="#">Programming the Digital Port</a> .
Elog	Starts external data logging (Elog). Note that external data logging must first be initiated. See <a href="#">External Data Logging</a> .
Arb	Starts the arbitrary waveform. Note that the waveform must first be enabled and initiated. See <a href="#">Programming Output Transients</a> .

Note that the trigger system can be combined with user-defined signal expressions to provide control signals for specific applications. See [Using Expression Signal Routing](#).

### Trigger Diagram

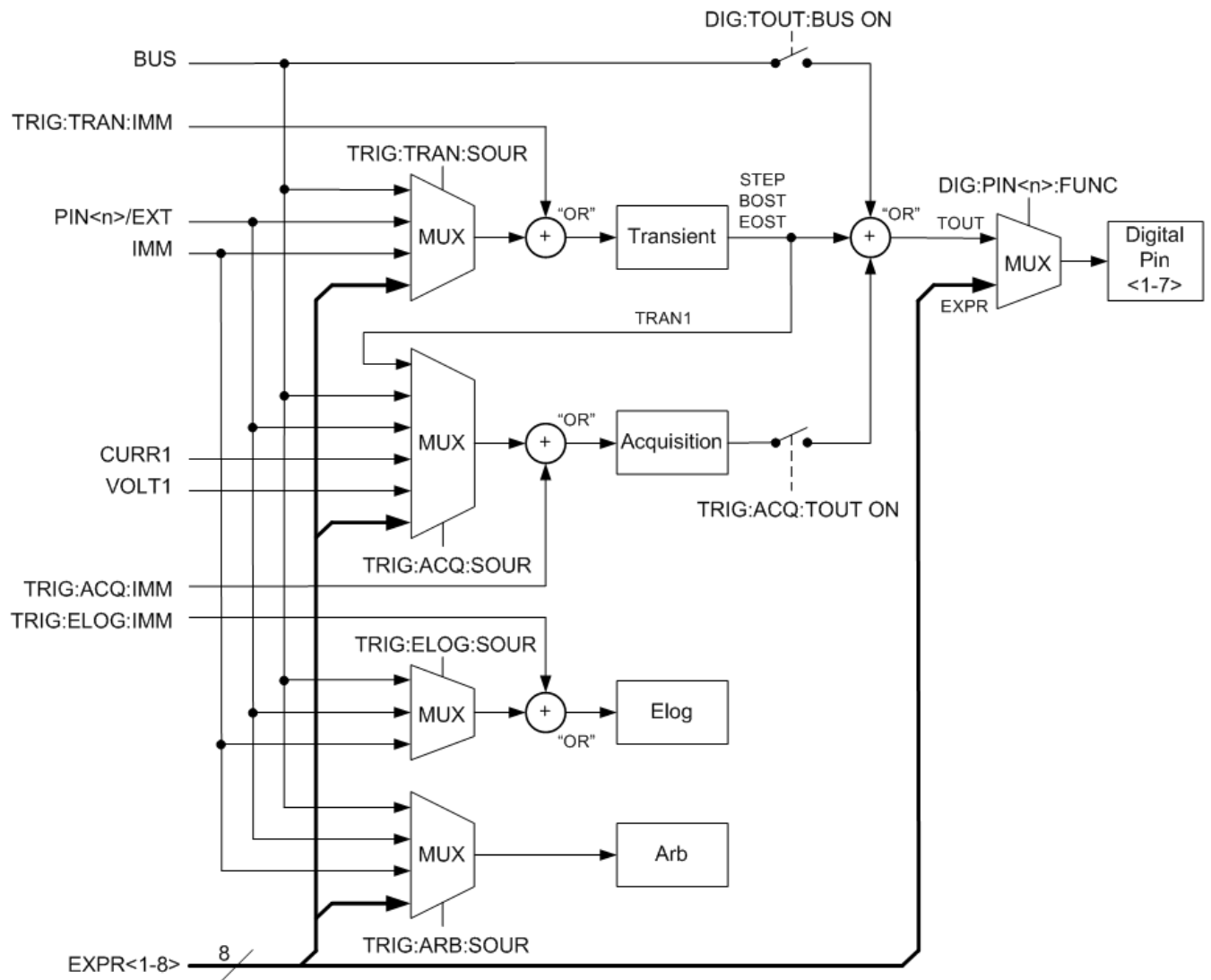

## Reset State (\*RST)

**NOTE**

The power-on/reset state may differ from that shown below if you have enabled power-on state recall mode from the **States** menu (see **Instrument State Storage**).

The following table shows the reset state. These parameters are reset to the indicated values at power-on or after \*RST.

### Reset Settings

SCPI Command *RST Settings	
ARB:COUNT	1
ARB:CURRENT:CDWell:DWELL	0.001
ARB:FUNCTION:SHAPE	NONE
ARB:FUNCTION:TYPE	VOLTage
ARB:TERMinate:LAST	OFF
ARB:VOLTage:CDWell:DWELL	0.001
CALibrate:STATE	OFF
CURRENT	0
CURRENT:LIMit	1.02% of rating
CURRENT:LIMit:NEGative	-10.2% of rating
CURRENT:MODE	FIXed
CURRENT:PROTECTION:DELay	20 ms
CURRENT:PROTECTION:DELay:START	SCHange
CURRENT:PROTECTION:STATE	OFF
CURRENT:SHARing	OFF
CURRENT:SLEW	MAX
CURRENT:SLEW:MAXimum	ON
CURRENT:TRIGgered	0
DIGital:OUTPut:DATA	0
DIGital:TOUTput:BUS	OFF
DISPlay	ON
FUNCTION	VOLTage
LIST:COUNT	1
LIST:CURRENT	1 step set to 0
LIST:DWELL	1 step set to 0.001
LIST:STEP	AUTO
LIST:TERMinate:LAST	OFF

## 6 SCPI Programming Reference

SCPI Command *RST Settings	
LIST:TOUTput:BOSTep	1 step set to OFF
LIST:TOUTput:EOSTep	1 step set to OFF
LIST:VOLTage	1 step set to 0.1% of rating
LXI:IDENTify	OFF
OUTPut	OFF
OUTPut:DELay:FALL	0
OUTPut:DELay:RISE	0
OUTPut:PROTection:MODE	LOWZ
OUTPut:PROTection:USER	OFF
OUTPut:PROTection:USER:SOURce	NONE
OUTPut:PROTection:WDOG	OFF
OUTPut:PROTection:WDOG:DELay	60
OUTPut:RELAy:POLarity	NORMAL
RESistance	0
RESistance:STATe	0
SENSe:CURRent:RANGe:AUTO	ON
SENSe:ELOG:CURRent:RANGe:AUTO	ON
SENSe:ELOG:FUNcTion:CURRent	OFF
SENSe:ELOG:FUNcTion:CURRent:MINMax	OFF
SENSe:ELOG:FUNcTion:VOLTage	OFF
SENSe:ELOG:FUNcTion:VOLTage:MINMax	OFF
SENSe:ELOG:PERiod	0.1
SENSe:FAULt:STATe	ON
SENSe:FUNcTion:CURRent	1
SENSe:FUNcTion:VOLTage	1
SENSe:SWEep:NPLCycles	1
SENSe:SWEep:OFFSet:POINts	0
SENSe:SWEep:POINts	3255 (60 Hz); 3906 (50 Hz)
SENSe:SWEep:TINTerval	5.12E-6
SENSe:THReshold<n>:AHOuR	0
SENSe:THReshold<n>:CURRent	0
SENSe:THReshold<n>:FUNcTion	VOLTage
SENSe:THReshold<n>:OPERation	GT
SENSe:THReshold<n>:POWer	0

SCPI Command *RST Settings	
SENSe:THReshold<n>:VOLTage	0
SENSe:THReshold<n>:WHOur	0
SENSe:WINDow	RECTangular
STEP:TOUTput	OFF
TRIGger:ACQuire:CURRent	0
TRIGger:ACQuire:CURRent:SLOPe	POSitive
TRIGger:ACQuire:SOURce	BUS
TRIGger:ACQuire:TOUTput	OFF
TRIGger:ACQuire:VOLTage	0
TRIGger:ACQuire:VOLTage:SLOPe	POSitive
TRIGger:ARB:SOURce	BUS
TRIGger:ELOG:SOURce	BUS
TRIGger:TRANsient:SOURce	BUS
VOLTage	0.1% of rating
VOLTage:LIMit	1% of rating
VOLTage:MODE	FIXed
VOLTage:PROTection	120% of rating
VOLTage:SLEW	MAX
VOLTage:SLEW:MAXimum	ON
VOLTage:TRIGgered	0.1% of rating

The following table shows the as-shipped settings of the **non-volatile** parameters. These are not affected by power cycling or \*RST.

#### Non-Volatile Settings

SCPI as-shipped settings	
CALibrate:DATE	March 5, 2003
CALibrate:PASSword	0
DIGital:PIN<all>:FUNCTion	DINput
DIGital:PIN<all>:POLarity	POSitive
DISPlay:VIEW	METER_VI
OUTPut:COUPle	OFF
OUTPut:COUPle:DOFFset	0
OUTPut:INHibit:MODE	OFF
OUTPut:PON:STATe	RST

## 6 SCPI Programming Reference

<b>SCPI as-shipped settings</b>	
OUTPut:RElAy:LOCK	OFF
OUTPut:RElAy:POLarity:ENABLE	ON
SENSe:BBR:PERiod	0.01
SYSTem:LFRequency:MODE	AUTO
<b>Front Panel as-shipped settings</b>	
Front panel lockout password	Disabled
Firmware update password protected	Disabled
GPIB address	5
GPIB interface	Enabled
LAN interface	Enabled
USB interface	Enabled
Screen saver	Enabled
Screen saver delay	60 minutes
Wake on I/O	Enabled
<b>Interface as-shipped settings</b>	
Get GPIB Address	Automatic
IP Address	169.254.69.79
Subnet mask	255.255.0.0
Default gateway	0.0.0.0
Host name	A- <serial number>
mDNS service name	Keysight N79xxx Dynamic DC Power-Supply <serial number>
LAN service - VXI-11	Enabled
LAN service - Telnet	Enabled
LAN service - mDNS	Enabled
LAN service - Web server	Enabled
LAN service - sockets	Enabled
Web password	Blank

## SCPI Error Messages

The Keysight instrument returns error messages in accord with the SCPI standard.

- Up to 20 errors can be stored in each interface-specific error queue (one each for GPIB, USB, VXI-11, and Telnet/Sockets.) Errors appear in the error queue of the I/O session that caused the error.
- The front-panel ERR annunciator turns on when there are one or more errors are in the error queue.
- A special global error queue holds all power-on and hardware-related errors (for example, over-temperature).
- Error retrieval is first-in-first-out (FIFO), and errors are cleared as you read them. Once you have read all interface-specific errors, the errors in the global error queue are retrieved. When you have read all errors from the error queue, the ERR annunciator turns off.
- If more than 20 errors have occurred, the last error stored in the queue (the most recent error) is replaced with -350, "Error queue overflow". No additional errors are stored until you remove errors from the queue. If no errors have occurred when you read the error queue, the instrument responds with +0, "No error".
- The front panel reports errors from all I/O sessions and the global error queue. To read the error queue from the front panel, press the ERROR key.
- Error conditions are also summarized in the Status Byte Register. See [Status Subsystem Introduction](#) for details
- The interface-specific error queues are cleared by power cycles and \*CLS. The error queue is not cleared by \*RST.
- SCPI:

`SYSTem:ERRor?` *Read and clear one error from the queue*

Errors have the following format (the error string may contain up to 255 characters):

### **Error Device-dependent Errors (these errors set Standard Event Status register bit #3)**

0 No error

This is the response to the ERR? query when there are no errors.

101 Calibration state is off

Calibration is not enabled. The instrument will not accept calibration commands.

102 Calibration password is incorrect

The calibration password is incorrect.

103 Calibration is inhibited by switch setting

Calibration mode is locked out by the calibration switch.

## 6 SCPI Programming Reference

### 104 Bad sequence of calibration commands

Calibration commands have not been entered in the proper sequence.

### 105 Unexpected output current

The measured output current is outside the acceptable range.

### 106 Zero measurement out of range error

The “zero” measurement value is outside the acceptable range.

### 107 Programming cal constants out of range

The programmed calibration constant is outside the acceptable range.

### 108 Measurement cal constants out of range

The measurement calibration constant is outside the acceptable range.

### 109 Over voltage cal constants out of range

The over voltage calibration constant is outside the acceptable range.

### 110 Wrong V+I

The instrument was unable to set the correct voltage or current value.

### 114 Wrong status

An incorrect status function has been reported.

### 116 Locked out by internal switch setting

This function has been locked out by an internal switch.

### 117 Calibration error

A calibration error has occurred. Do not save calibration constants. Try re-calibrating the unit.

### 200 Hardware error channel <1>

A hardware error has occurred on the output.

### 202 Selftest Fail

A selftest failure has occurred. See selftest failure list for details.

### 203 Compatibility function not implemented

The requested compatibility function is not available.

### 204 NVRAM checksum error

A checksum error has occurred in the instrument’s nonvolatile random access memory.

### 205 NVRAM full

The nonvolatile random access memory of the instrument is full.

**206 File not found**

The internal calibration file or the internal channel attribute file was not found in NVRAM.

**207 Cal file version error**

The calibration file was written or read using old firmware. Firmware must be updated.

**208 Running backup firmware**

The instrument is presently running the backup (previous) version of the firmware.

**210 Frame NVRAM error**

A non-volatile RAM error has occurred in the instrument.

**212 State file not loaded**

A previously saved output state file has failed to load.

**213 Sinkbox error**

A cable has disconnected or a hardware error has occurred on the power dissipator.

**214 Line frequency error**

A discrepancy has occurred between the line frequency and the line frequency setting.

**215 Hardware failure**

A hardware failure has occurred on the power supply or the power dissipator

**302 Option not installed**

The option that is programmed by this command is not installed.

**303 There is not a valid acquisition to fetch from**

There is no valid data in the measurement buffer.

**304 Volt and curr in incompatible transient modes**

Voltage and current cannot be in Step and List mode at the same time.

**305 A triggered value is on a different range**

A triggered value is on a different range than the one that is presently set.

**306 Too many list points**

Too many list points have been specified.

**307 List lengths are not equivalent**

One or more lists are not the same length.

**308 This setting cannot be changed while transient trigger is initiated**

Setting cannot be changed while the instrument is waiting for or executing a trigger sequence.

## 6 SCPI Programming Reference

### 309 Cannot initiate, voltage and current in fixed mode

Cannot initiate transient generator. Either the voltage or current function is set to Fixed mode.

### 310 The command is not supported by this model

This instrument either does not have the hardware capability or the options required to support this command.

### 314 Time of day clock has stopped

The time of day clock has stopped . Replace the internal battery. See service section.

### 315 Settings conflict error

A data element could not be programmed because of the present instrument state.

### 320 Firmware update error

This may be due to the instrument hardware not being able to support the firmware version.

## **Command Errors (these errors set Standard Event Status register bit #5)**

### -100 Command error

Generic syntax error.

### -101 Invalid character

An invalid character was found in the command string.

### -102 Syntax error

Invalid syntax was found in the command string. Check for blank spaces.

### -103 Invalid separator

An invalid separator was found in the command string. Check for proper use of , ; :

### -104 Data type error

A different data type than the one allowed was found in the command string.

### -105 GET not allowed

A group execute trigger is not allowed in a command string.

### -108 Parameter not allowed

More parameters were received than were expected.

### -109 Missing parameter

Fewer parameters were received than were expected.

### -110 Command header error

An error was detected in the header.

-111 Header separator error

A character that was not a valid header separator was found in the command string.

-112 Program mnemonic too long

The header contains more than 12 characters.

-113 Undefined header

A command was received that was not valid for this instrument.

-114 Header suffix out of range

The value of the numeric suffix is not valid.

-120 Numeric data error

Generic numeric data error.

-121 Invalid character in number

An invalid character for the data type was found in the command string.

-123 Exponent too large

The magnitude of the exponent was larger than 32000.

-124 Too many digits

The mantissa of a numeric parameter contained more than 255 digits, excluding leading zeros.

-128 Numeric data not allowed

A numeric parameter was received but a character string was expected.

-130 Suffix error

Generic suffix error

-131 Invalid suffix

A suffix was incorrectly specified for a numeric parameter.

-134 Suffix too long

The suffix contains more than 12 characters.

-138 Suffix not allowed

A suffix is not supported for this command.

-140 Character data error

Generic character data error

-141 Invalid character data

Either the character data element contains an invalid character, or the element is not valid.

## 6 SCPI Programming Reference

### -144 Character data too long

The character data element contains more than 12 characters.

### -148 Character data not allowed

A discrete parameter was received, but a string or numeric parameter was expected.

### -150 String data error

Generic string data error

### -151 Invalid string data

An invalid character string was received. Check that the string is enclosed in quotation marks.

### -158 String data not allowed

A character string was received, but is not allowed for this command.

### -160 Block data error

Generic block data error

### -161 Invalid block data

The number of data bytes sent does not match the number of bytes specified in the header.

### -168 Block data not allowed

Data was sent in arbitrary block format but is not allowed for this command.

### -170 Expression error

Generic expression error

### -171 Invalid expression data

The expression data element was invalid.

### -178 Expression data not allowed

Expression data element was sent but is not allowed for this command.

## **Execution Errors (these errors set Standard Event Status register bit #4)**

### -200 Execution error

Generic syntax error

### -220 Parameter error

A data element related error occurred.

### -221 Settings conflict

A data element could not be executed because of the present instrument state.

-222 Data out of range

A data element could not be executed because the value was outside the valid range.

-223 Too much data

A data element was received that contains more data than the instrument can handle.

-224 Illegal parameter value

An exact value was expected but not received.

-225 Out of memory

The device has insufficient memory to perform the requested operation.

-226 Lists not same length

One or more lists are not the same length.

-230 Data corrupt or stale

Possible invalid data. A new reading was started but not completed.

-231 Data questionable

The measurement accuracy is suspect.

-232 Invalid format

The data format or structure is inappropriate.

-233 Invalid version

The version of the data format is incorrect to the instrument.

-240 Hardware error

The command could not be executed because of a hardware problem with the instrument.

-241 Hardware missing

The command could not be executed because of missing hardware, such as an option.

-260 Expression error

An expression program data element related error occurred.

-261 Math error in expression

An expression program data element could not be executed due to a math error.

**Query Errors (these errors set Standard Event Status register bit #2)**

-400 Query Error

Generic error query

-410 Query INTERRUPTED

A condition causing an interrupted query error occurred.

-420 Query UNTERMINATED

A condition causing an unterminated query error occurred.

-430 Query DEADLOCKED

A condition causing a deadlocked query error occurred.

-440 Query UNTERMINATED after indefinite response

A query was received in the same program message after a query indicating an indefinite response was executed.

## Compatibility Commands

The commands described in this section are provided for compatibility with existing N6700 series modular power systems (MPS). Specifically, because of their feature sets, only programs written for the N673xB, N674xB, and N677xA power modules are directly compatible with the APS models. Note that the compatibility commands discussed in this section have no or little effect on the operation of the APS models, as they access functions that are either redundant or not available.

### Channel Parameter

Since the APS models are single channel units, SCPI commands do not require a channel list parameter. However, for code compatibility with the N6700 MPS, the APS models will accept the channel list (, @1) for N6700 MPS commands that require this parameter. All channel-dependent commands sent to the APS models must be sent to channel 1 only.

### Aliased Commands

Certain N6700 MPS commands are aliased or linked to newer APS commands for compatibility. This allows the N6700 MPS commands to be used in APS models without modification.

N6700 MPS command	Aliased to these APS commands
[SOURce:]CURRent Sets the output current.	[SOURce:]CURRent:LIMit[:POSitive] Sets the current limit when in voltage priority mode.
DISPlay:VIEW METER1 Displays a single output channel	DISPlay:VIEW METER_VI Displays output voltage and current.
DISPlay:VIEW METER4 Displays four output channels	DISPlay:VIEW METER_VI Displays output voltage and current.

Obsolete N6700 MPS commands	Aliased to these N6700 MPS and APS commands
OUTPut:PROT:DElay Sets the output protection delay.	[SOURce:]CURRent:PROTection:DElay Sets the output protection delay.

#### NOTE

It is not recommended to use obsolete commands in new application programs.

### Code Compatible Commands

These Keysight N6700 MPS commands are not required for APS models, but are provided for better compatibility with code written for the N6700 MPS. In most cases these commands either do nothing, or specify a pre-defined parameter that is compatible with the APS models.

N6700 MPS command	Action on APS models
OUTPut:COUPle:CHANnel Couples output channels together.	Does nothing.
OUTPut:PROTection:COUPle Couples protection on output channels.	Does nothing.
SENSe:CURRent:COMPensate Sets the output current compensation.	Does nothing.
SENSe:FUNcTion:CURRent Enables current measurements.	Current measurements are always enabled.
SENSe:FUNcTion:VOLTage Enables voltage measurements.	Voltage measurements are always enabled.
SENSe:VOLTage:RANGe Sets the output voltage range.	Does nothing.
SENSe:ELOG:VOLTage:RANGe Sets the external datalog voltage range.	Does nothing.
[SOURce:]ARB:FUNcTion:SHAPE Selects an Arb function, or None.	The CDWell Arb function is always selected.
[SOURce:]CURRent:RANGe Sets the output current range.	Does nothing.
[SOURce:]VOLTage:RANGe Sets the output voltage range.	Does nothing.
SYSTem:CHANnel[:COUNT]? Returns the number of output channels.	Always returns a "1".
SYSTem:CHANnel:MODel? Returns the channel model number.	Returns the power supply model. Same as *IDN?
SYSTem:CHANnel:OPTion? Returns the channel options.	Returns the power supply options. Same as *OPT?
SYSTem:CHANnel:SERial? Returns the channel serial number.	Returns the power supply serial number. Same as *IDN?
SYSTem:GROUp:DEFine Groups up to four output channels.	Does nothing.
SYSTem:GROUp:CATalog? Returns the number of grouped channels.	Always returns a "1".
SYSTem:GROUp:DELeTe Ungroups the specified channels.	Does nothing.
SYSTem:GROUp:DELeTe:ALL Ungroups all channels.	Does nothing.

## Commands and Parameters that Work Differently

STEP and LIST commands only apply to the priority mode that is presently active in the APS (either voltage-priority or current-priority mode). This is unlike the N6700 MPS commands, which can STEP and LIST voltage and current simultaneously.

N6700 MPS command	APS command
[SOURce:]CURRent:TRIGgered [SOURce:]VOLTage:TRIGgered Generates a step when either a voltage or current step occurs.	[SOURce:]CURRent:TRIGgered [SOURce:]VOLTage:TRIGgered Generates a step when a voltage step occurs in voltage priority mode. Generates a step when a current step occurs in current priority mode.
[SOURce:]LIST commands Generates an output voltage and output current list.	[SOURce:]LIST commands Generate a voltage list in voltage priority mode. Generate a current list in current priority mode.
QUEStionable:STATus? Constant current mode indicated by CC bit.	QUEStionable:STATus? Positive current limit indicated by +LIM bit.

# 7

## Verification and Calibration

**Recommended Test Equipment and Setups**

**Performance Verification**

**Calibration Procedure**

**Test Record Forms**

## Recommended Test Equipment and Setups

### Test Equipment

### Measurement Techniques

### Test Considerations

### Verification Setups

### Calibration Setups

## Test Equipment

The test equipment recommended for the performance verification and adjustment procedures is listed below. If the exact instrument is not available, substitute calibration standards of equivalent accuracy.

Instrument	Requirements	Recommended Model	Use*
Digital Multimeter	Resolution: 10 nV @ 1V; Readout: 8 1/2 digits Accuracy: 20 ppm	Keysight 3458A	V, C
Current Shunt	15 A (0.1 $\Omega$ ) 0.04%, TC=5ppm/ $\Omega$ C 100 A (0.01 $\Omega$ ) 0.04%, TC=5ppm/ $\Omega$ C 300 A (0.001 $\Omega$ ) 0.04%, TC=5ppm/ $\Omega$ C	Guildline 9230/15 Guildline 9230/100 Guildline 9230/300	V, C
Electronic load	80 V, 200 A minimum	2 - Keysight N3300A mainframes; 6 - Keysight N3305A modules	V
GPIB controller	Full GPIB capabilities	Keysight 82350B or equivalent	V, C
Oscilloscope	Sensitivity: 1 mV Bandwidth Limit: 20 MHz Probe: 1:1 with RF tip	Keysight Infiniium or equivalent	V
RMS Voltmeter	True RMS Bandwidth: 20 MHz Sensitivity: 100 $\mu$ V	Rhode and Schwartz Model URE3 or equi- valent	V
Differential Amplifier	Bandwidth: 20 MHz	LeCroy 1855A, DA1850A, or equivalent	V
Terminations	1 - 50 $\Omega$ BNC termination 2 - 50 $\Omega$ , 1/8 W termination resistors		V
Power Supply	160 V, 200 A, 2kW	Keysight N8754A, N8758A, N8761A	V, C

\* V=Verification C=Calibration

## Measurement Techniques

### Voltmeter

To ensure that the values read by the voltmeter during both the verification procedure and the calibration procedure are not affected by the instantaneous measurement of the AC peaks of the output current ripple, make several DC measurements and average them.

If you are using a Keysight 3458A DMM, you can set up the voltmeter to do this automatically. From the instrument's front panel, program 100 power line cycles per measurement. Press NPLC 100 ENTER. Additionally, turn on auto-calibration (ACAL) and the autorange function (ARANGE).

### Current Shunt

The 4-terminal current shunt is used to eliminate output current measurement error caused by voltage drops in the load leads and connections. It has special current-monitoring terminals inside the load connection terminals. Connect the voltmeter directly to these current-monitoring terminals.

### Electronic Load

Many of the test procedures require the use of a variable load capable of dissipating the required power. If a variable resistor is used, switches should be used to connect, disconnect, or short the load resistor. For most tests, an electronic load can be used. The electronic load is considerably easier to use than load resistors, but it may not be fast enough to test transient recovery time and may be too noisy for the noise (PARD) tests.

Fixed load resistors may be used in place of a variable load, with minor changes to the test procedures. Also, if computer controlled test setups are used, the relatively slow (compared to computers and system voltmeters) settling times and slew rates of the power system may have to be taken into account. "Wait" statements can be used in the test program if the test system is faster than the power system.

## Test Considerations

For optimum performance, all verification and calibration procedures should comply with the following:

- Ambient temperature is stable, between 18 and 28 °C.
- Ambient relative humidity is less than 80%.
- 30 minute warm-up period before verification or adjustment.
- Cables as short as possible, twisted or shielded to reduce noise.

**Verification Setups**

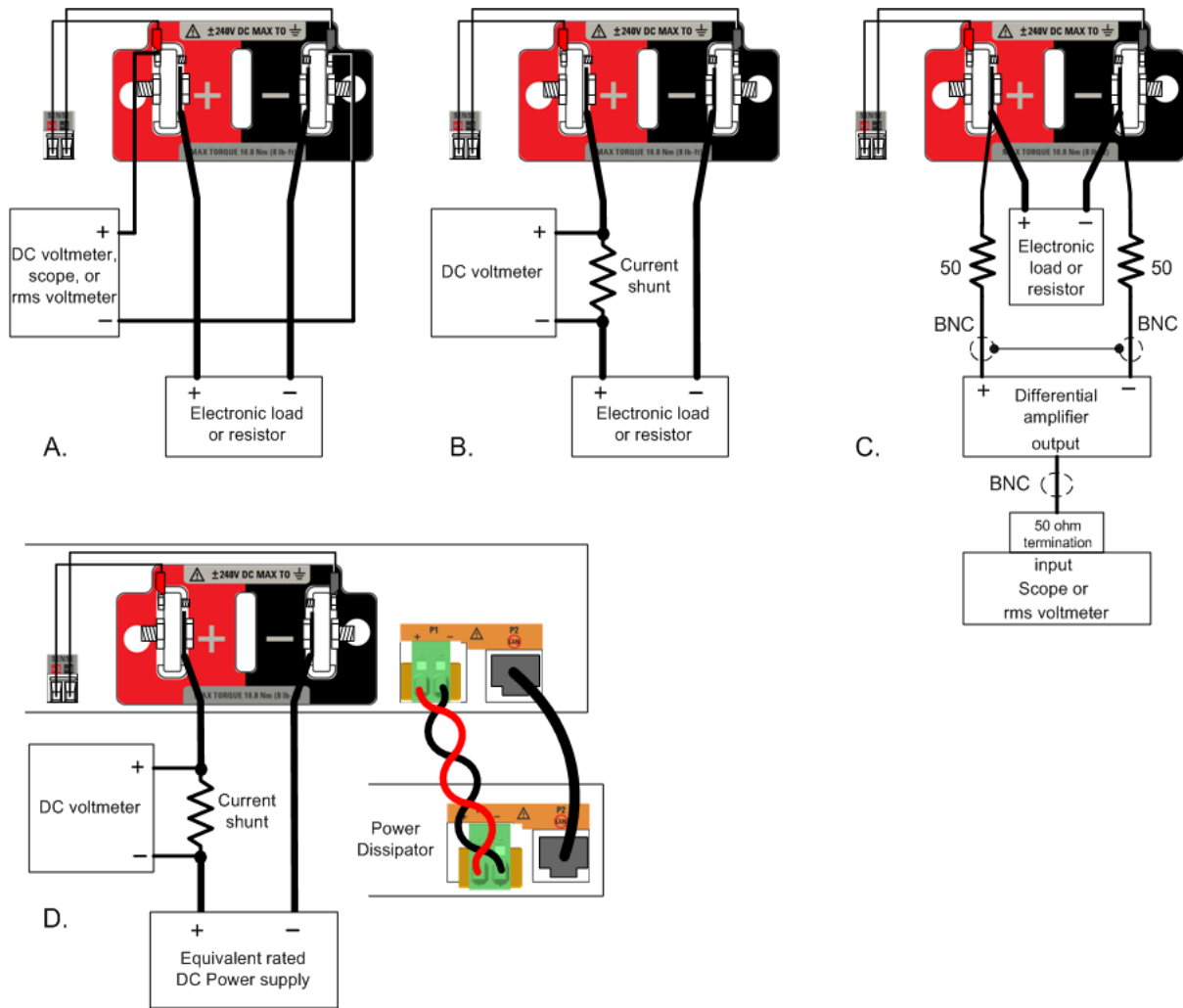

**Calibration Setups**

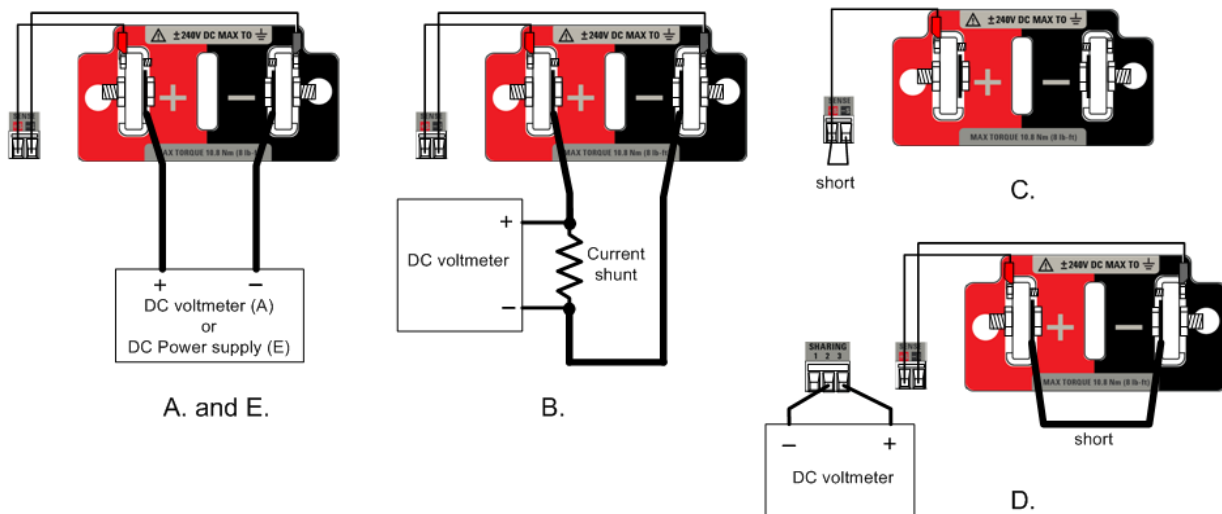

## Performance Verification

### Voltage Programming and Readback Accuracy

#### Constant Voltage Load Effect

#### Constant Voltage Ripple and Noise

#### Transient Recovery Time

### Current Programming and Readback Accuracy

#### Constant Current Load Effect

#### Current Sink Capability Verification

## Introduction

Use the performance verification tests to verify that the power supply is operating normally and meets its published specifications. You can perform two different levels of performance verification tests:

- **Self-Test** A brief power-on self-test occurs automatically whenever you turn on the instrument. This limited test assures that the instrument is operational. For details, see [Self-Test Procedures](#).
- **Performance Verification Tests** An extensive set of tests that are recommended as an acceptance test when you first receive the instrument or after performing adjustments.

The performance verification tests are recommended as acceptance tests when you first receive the instrument. The acceptance test results should be compared against the instrument specifications. After acceptance, you should repeat the performance verification tests at every calibration interval.

Perform the verification tests before calibrating your power system. If the power supply passes the verification tests, the unit is operating within its calibration limits and does not need to be calibrated.

If the instrument fails any of the tests or if abnormal test results are obtained, try calibrating the unit. If calibration is unsuccessful, return the unit to a Keysight Technologies Service Center.

Refer to the [Recommended Test Equipment and Setups](#) section for a list of the equipment and test setups required for verification. Refer to the [Measurement Techniques](#) section for information about connecting the voltmeter, current shunt, and load.

## Voltage Programming and Readback Accuracy

This test verifies that the voltage programming and measurement functions are within specifications.

Step 1. Turn off the power supply. Connect a DMM to the sense terminals (see [Test Setup A](#)). Do not connect the load.

Step 2. Turn on the power supply and program the instrument settings as described in the test record form under “Voltage Programming & Readback, Min Voltage”. Turn the output on. The output status should be “CV” and the output current should be close to zero.

## 7 Verification and Calibration

Step 3. Record the output voltage reading from the DMM and the voltage measured over the interface. The readings should be within the limits specified in the test record form for the appropriate model under “Voltage Programming & Readback, Minimum Voltage”.

Step 4. Program the instrument settings as described in the test record form under “Voltage Programming & Readback, High Voltage”.

Step 5. Record the output voltage reading from the DMM and the voltage measured over the interface. The readings should be within the limits specified in the test record form for the appropriate model under “Voltage Programming & Readback, High Voltage”.

### Constant Voltage Load Effect

This test measures the change in output voltage resulting from a change in output current from full load to no load.

Step 1. Turn off the power supply and connect a DMM and an electronic load (see [Test Setup A](#)).

Step 2. Turn on the power supply and program the instrument settings as described in the test record form under “CV Load Effect”.

Step 3. Set the electronic load for the output current as described in the test record form under “CV Load Effect”. The output status should be “CV”. If it isn’t, adjust the load so that the output current drops slightly.

Step 4. Record the output voltage reading from the DMM.

Step 5. Open the load. Record the voltage reading from the DMM again. The difference between the DMM readings in steps 4 and 5 is the load effect, which should not exceed the value listed in the test record form for the appropriate model under “CV Load Effect”.

### Constant Voltage Ripple and Noise

Periodic and random deviations in the output combine to produce a residual AC voltage superimposed on the DC output voltage. This residual voltage is specified as the rms or peak-to-peak noise in the indicated frequency range (see [Specifications](#)).

Step 1. Turn off the power supply and connect an electronic load, differential amplifier, and an oscilloscope (ac coupled) to the output (see [Test Setup C](#)).

Step 2. As shown in the diagram, use two BNC cables terminated by a 50  $\Omega$  resistor to connect the differential amplifier to the + and - output terminals. The shields of the two BNC cables should be connected together. Connect the output of the differential amplifier to the oscilloscope with a 50  $\Omega$  termination at the input of the oscilloscope.

Step 3. Set the differential amplifier to multiply by ten, divide by one, and 1 M $\Omega$  input resistance. The positive and negative inputs of the differential amplifier should be set to AC coupling. Set the oscilloscope’s time base to 5 ms/div, and the vertical scale to 10 mV/div. Turn the bandwidth limit on (usually 20 MHz), and set the sampling mode to peak detect.

Step 4. Program the power system to the settings indicated in the in the test record form for the appropriate model under “CV Ripple and Noise” and enable the output. Let the oscilloscope run for a few seconds to generate enough measurement points. On the Keysight Infiniium scope, the maximum peak-to-peak voltage measurement is indicated at the bottom of the screen on the right side. Divide this value by 10 to get the CV peak-to-peak noise measurement. The result should not exceed the peak-to-peak limits in the test record form for the appropriate model under “CV Ripple and Noise, peak-to-peak”.

**NOTE**

If the measurement contains any question marks, clear the measurement and try again. This means that some of the scope data received was questionable.

Step 5. Disconnect the oscilloscope and connect an rms voltmeter in its place. Do not disconnect the 50 ohm termination. Divide the reading of the rms voltmeter by 10. The result should not exceed the rms limits in the test record form for the appropriate model under “CV Ripple and Noise, rms”.

### Transient Recovery Time

This test measures the time for the output voltage to recover to within the specified value following a 50% change in the load current.

Step 1. Turn off the power supply and connect an oscilloscope across the sense terminals (see **Test Setup A**). Connect an electronic load to the output terminals.

Step 2. Turn on the power supply and program the instrument settings as described in the test record form under “Transient Response”.

Step 3. Set the electronic load to operate in constant current mode. Program its load current to the lower current value indicated in the test record form under “Transient Response”.

Step 4. Set the electronic load's transient generator frequency to 100 Hz and its duty cycle to 50%.

Step 5. Program the load's transient current level to the higher current value indicated in the test record form under “Transient Response”, and turn the transient generator on.

Step 6. Adjust the oscilloscope for a waveform similar to that shown in the following figure.

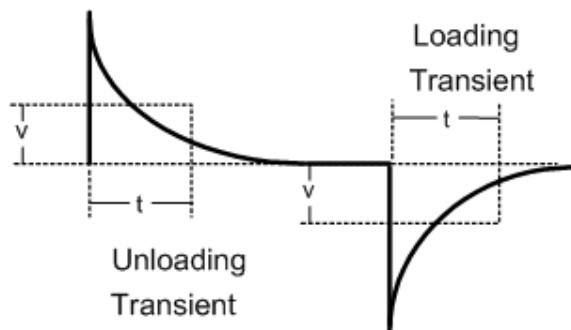

Step 7. The output voltage should return to within the specified voltage at the specified time following the 50% load change. Check both loading and unloading transients by triggering on the positive and negative slope. Record the voltage at time “t” in the performance test record form under “Transient Response”.

## Current Programming and Readback Accuracy

This test verifies that the current programming and measurement functions are within specifications.

Step 1. Turn off the power supply and connect the current shunt directly across the output terminals. Connect the DMM directly across the current shunt (see **Test Setup B**). Note that the electronic load is not used in this portion of the test.

Step 2. Turn on the power supply and program the instrument settings as described in the test record form under “Current Programming & Readback, Min Current”. The output status should be “CC”, and the output voltage should be close to zero. Wait 5 minutes for the temperature to settle.

Step 3. Divide the voltage drop (DMM reading) across the current shunt by the shunt resistance to convert to amps and record this value. Also, record the current measured over the interface. The readings should be within the limits specified in the test record form for the appropriate model under “Current Programming & Readback, Minimum Current”.

Step 4. Program the instrument settings as described in the test record form under “Current Programming & Readback, High Current”. Wait 5 minutes for the temperature to settle.

Step 5. Divide the voltage drop (DMM reading) across the current shunt by the shunt resistance to convert to amps and record this value. Also, record the current reading measured over the interface. The readings should be within the limits specified in the test record form for the appropriate model under “Current Programming & Readback, High Current”.

Step 6. For **N7900 models** and **N6900 Opt 301**, set the current measurement to the low range. Set the instrument as described under “Current Readback, Low Current”. Wait 5 minutes for the temperature to settle.

Step 7. Record the current measured over the interface. The readings should be within the limits specified under “Low Current Readback Low Range”.

## Constant Current Load Effect

This test measures the change in output current resulting from a change in output voltage from full scale to short circuit.

Step 1. Turn off the power supply and connect the current shunt, DMM, and electronic load (see **Test Setup B**). Connect the DMM directly across the current shunt.

Step 2. Turn on the power supply and program the instrument settings as described in the test record under “CC Load Effect”.

Step 3. Set the electronic load for CV mode and program it to the output’s voltage as described in the test record under “CC Load Effect”. The output status should be “CC”. If it isn’t, adjust the load so that the output voltage drops slightly.

Step 4. Divide the voltage drop (DMM reading) across the current shunt by the shunt resistance to convert to amps and record this value.

Step 5. Short the electronic load. Divide the voltage drop (DMM reading) across the current shunt by the shunt resistance to convert to amps and record this value. The difference in the current readings in steps 4 and 5 is the load effect, which should not exceed the value listed in the test record for the appropriate model under “CC Load Effect”.

### Current Sink Capability Verification

This test checks the ability of the power supply to sink up to 10% of its rated output current. If one or more Keysight N7909A Power Dissipators are connected, this test verifies that the power supply can sink up to 100% of its rated output current.

Step 1. Turn off the power supply and connect an external power supply to the + and - output terminals (see **Test Setup D**). Connect the power dissipator as shown if you are verifying 100 % of the current sinking capability the power supply.

Step 2. Set the external supply as follows: Voltage setting = 100 % of the rated output voltage of the power supply under test. Current limit setting = 110 % of the rated output current of the power supply under test.

Step 3. Turn on the power supply under test. Set the operating mode to Current Priority. Program the instrument settings as described in the test record under “Current Sink Verification”.

Step 4. Check the front panel display of the power supply and verify that the supply is sinking either 10% or 100 % of its rated current. Divide the voltage drop (DMM reading) across the current shunt by the shunt resistance to convert to amps and record this value. The readings should be within the limits specified in the test record form for the appropriate model under “Current Sink Tests”.

**NOTE**

If you are checking the current sink capability of a 2 kW unit connected to only one power dissipator unit (@ 50% of the power supply's rated current), divide the 100% values in the test record form in half.

## Calibration Procedure

### Calibration Interval

### Enter Calibration Mode

### Voltage Calibration

### Voltage Common Mode Rejection Ratio Calibration

### Current Calibration

### Current Temperature Coefficient Calibration

### Current Sharing Calibration

### Resistance Bottom-Out Calibration

### Enter a Calibration Date

### Save Calibration and Log Out

## Introduction

The instrument features closed-case electronic calibration; no internal mechanical adjustments are required. The instrument calculates correction factors based on input reference values that you set and stores correction factors in non-volatile memory until the next calibration adjustment is performed. This EEPROM calibration memory is not changed by cycling power or \*RST.

Refer to the **Recommended Test Equipment and Setups** section for a list of the equipment and test setups required for calibration. Refer to the **Measurement Techniques** section for information about connecting the voltmeter, current shunt, and load. Additional information about calibration follows.

- The correct password is required to enter the Admin menu, which contains the calibration function. The password is pre-set to 0 (zero). You can change the password once calibration mode is entered to prevent unauthorized access to the calibration mode. Refer to **Password Protection** for more information.
- When calibrating the unit using SCPI commands, most steps involve sending a \*OPC? query to synchronize with the power system's command completion before proceeding. The response from the instrument must be read each time \*OPC? is given. In some steps, it may take up to 30 seconds for \*OPC? to respond.
- Once started, you must complete each calibration section in its entirety. As each calibration section is completed, the instrument calculates new calibration constants and begins using them. However, these constants are not saved in nonvolatile memory until a SAVE command is explicitly given.
- Exit the calibration mode either by logging out of the Admin menu or by sending CAL:STAT OFF. Note that any calibration section that was calibrated but not saved will revert to its previous calibration constants.

## Calibration Interval

Keysight Technologies recommends that complete verification should always be performed at the calibration interval. If the power supply passes the verification tests, the unit is operating within its calibration limits and does not need to be calibrated. This ensures that the instrument will remain within specifications for the next calibration interval and provides the best long-term stability. Performance data measured using this method can be used to extend future calibration intervals.

### One Year Calibration Interval

The instrument should be calibrated on a regular interval determined by the accuracy requirements of your application. A **one-year** interval is adequate for most applications. Accuracy specifications are warranted only if adjustment is made at regular calibration intervals. Published accuracy specifications are not warranted beyond the one-year calibration interval.

### Three Year Calibration Interval

Voltage and current programming and measurement accuracy specifications can be extended to a three-year period calibration interval by multiplying (or increasing) the one-year calibration accuracy specifications shown in the verification **Test Record Forms** by a factor of three.

## Enter Calibration Mode

Front Panel Menu Reference	SCPI Command
Select <b>System\Admin&gt;Login</b> . Enter your password in the Password field. Then press <b>Select</b> .	<b>CAL:STAT ON &lt;password&gt;</b>

## Voltage Calibration

### Voltage Programming and Measurement

Step 1. Connect the voltage input of the Keysight 3458A DMM to the output (see **Cal Setup A**).

Step 2. Select the voltage programming and measurement calibration.

Front Panel Menu Reference	SCPI Command
Select <b>System\Admin\Cal\Vprog</b> . Check that the voltmeter is connected and select <b>Next</b> .	Specify the full-scale voltage range. Full scale ranges vary by model. This selects the 60 V range: <b>CAL:VOLT 60</b>

Step 3. Select the first voltage calibration point. Measure the output voltage with the DMM and enter the data.

Front Panel Menu Reference	SCPI Command
Display shows: "Enter P1 measured data". Enter the data from the external DMM. Press <b>Enter</b> when done.	<b>CAL:LEV P1</b> <b>*OPC?</b> <b>CAL:DATA &lt;data&gt;</b>

## 7 Verification and Calibration

Step 4. Select the second voltage calibration point. Measure the output voltage with the DMM and enter the data.

Front Panel Menu Reference	SCPI Command
Display shows: "Enter P2 measured data". Enter the data from the external DMM. Press Enter when done. Press Back to finish.	<code>CAL:LEV P2</code> <code>*OPC?</code> <code>CAL:DATA &lt;data&gt;</code>

### Voltage Common Mode Rejection Ratio Calibration

Step 1. Make the connections shown in [Cal Setup C](#). Connect an external jumper between the +sense and the - sense terminals. Also connect the + sense terminal to the +output terminal. Do not connect anything to the -output terminals. The procedure is automatic and only takes a few seconds.

Step 2. Select the common mode rejection ratio calibration.

Front Panel Menu Reference	SCPI Command
Select <code>System\Admin\Cal\Misc\CMRR</code> . Check that the leads are connected as described and select Next.	<code>CAL:VOLT:CMRR</code> <code>*OPC?</code>

Step 3. After the calibration completes, reconnect the sense wiring.

### Current Temperature Coefficient Calibration

**NOTE**

The temperature coefficient calibration procedure must be performed **Before** any other current calibration procedures.

Step 1. Connect a precision shunt resistor to the output. The shunt resistor must be able to measure the output's **full-scale** current (see [Cal Setup B](#)). Connect the Keysight 3458A DMM across the shunt resistor.

Step 2. Select the temperature coefficient calibration.

Front Panel Menu Reference	SCPI Command
Select <code>System\Admin\Cal\Misc\CurrTC</code> . Check that the shunt is connected and select Next.	<code>CAL:CURR:TC</code>

Step 3. Select the first current calibration point. Wait 5 minutes for the temperature to settle. Calculate the shunt current ( $I=V/R$ ) and enter the data.

Front Panel Menu Reference	SCPI Command
Display shows: "Enter P1 measured data". Enter the data from the external DMM. This should be about 50% of the full-scale current rating. Press Enter when done.	<code>CAL:LEV P1</code> <code>*OPC?</code> <code>CAL:DATA &lt;data&gt;</code>

Step 4. Select the second current calibration point. Wait 5 minutes for the temperature to settle. Calculate the shunt current ( $I=V/R$ ) and enter the data.

Front Panel Menu Reference	SCPI Command
Display shows: "Enter P2 measured data". Enter the data from the external DMM. This should be about 80% of the full-scale current rating. Press Enter when done.	<b>CAL:LEV P2</b> <b>*OPC?CAL:DATA &lt;data&gt;</b>

Step 5. Select the third current calibration point. Wait 5 minutes for the temperature to settle. Calculate the shunt current ( $I=V/R$ ) and enter the data.

Front Panel Menu Reference	SCPI Command
Display shows: "Enter P3 measured data" Select the Measured Data field. Enter the data from the external DMM. This should be about 100% of the full-scale current rating. Press Enter when done. Press Back to finish.	<b>CAL:LEV P3</b> <b>*OPC?CAL:DATA &lt;data&gt;</b>

## Current Calibration

### Current Programming and High Range Measurement

Step 1. Disconnect all equipment from the output terminals.

Step 2. Select the current programming and high range measurement calibration.

Front Panel Menu Reference	SCPI Command
Select <b>System\Admin\Cal\Curr\lprog</b> . Check that nothing is connected to the output and select Next.	Specify the full-scale current range. Full scale ranges vary by model. This selects the 50 A range: <b>CAL:CURR 50</b>

Step 3. Wait 5 minutes for the temperature to settle. Select the first current calibration point.

Front Panel Menu Reference	SCPI Command
Wait 5 minutes, then select Next again.	<b>CAL:LEV P1</b> <b>*OPC?</b>

Step 4. Connect a precision shunt resistor to the output. The shunt resistor should be able to measure at least 70% of the output's full-scale current (see **Cal Setup B**). Connect the Keysight 3458A DMM across the shunt resistor.

Front Panel Menu Reference	SCPI Command
Check that the shunt is connected and select Next.	Not applicable

Step 5. Select the second current calibration point. Wait 5 minutes for the temperature to settle. Calculate the shunt current ( $I=V/R$ ) and enter the data.

## 7 Verification and Calibration

Front Panel Menu Reference	SCPI Command
Display shows: "Enter P2 measured data". Enter the data from the external DMM. This should be about 70% of the full-scale current rating. Press Enter when done. Press Back to finish.	CAL:LEV P2 *OPC? CAL:DATA <data>

### Current Low Range Measurement N7900 models N6900 Opt 301

Step 1. Disconnect all equipment from the output terminals.

Step 2. Select the current low range measurement calibration.

Front Panel Menu Reference	SCPI Command
Select <b>System\Admin\Cal\Curr\lmeas</b> . Check that the shunt is connected and select Next.	Specify the low range measurement. Low ranges vary by model. This selects the 2 A range: CAL:CURR:MEAS 2

Step 3. Select the first current calibration point. Wait 5 minutes for the temperature to settle.

Front Panel Menu Reference	SCPI Command
Wait 5 minutes, then select Next again.	CAL:LEV P1 *OPC?

Step 4. Connect a precision shunt resistor to the output. The shunt resistor should be able to measure the full-scale current of the low range (see **Cal Setup B**). Connect the Keysight 3458A DMM across the shunt resistor.

Front Panel Menu Reference	SCPI Command
Check that the shunt is connected and select Next.	Not applicable

Step 5. Select the second current calibration point. There is no wait required for the second point. Calculate the shunt current ( $I=V/R$ ) and enter the data.

Front Panel Menu Reference	SCPI Command
Display shows: "Enter P2 measured data". Enter the data from the external DMM. This should be about 100% of the full-scale low range rating. Press Enter when done. Press Back to finish.	CAL:LEV P2 *OPC? CAL:DATA <data>

### Current Sharing Calibration

This procedure calibrates the Imon signal that is used when units are connected in parallel.

Step 1. Connect a short across the + and - output terminals. Connect the Keysight 3458A DMM across pins 2 and 3 of the Sharing connector (see **Cal Setup D**).

Step 2. Select the current sharing calibration.

Front Panel Menu Reference	SCPI Command
Select <b>System\Admin\Cal\Misc\CurrShar</b> .	<b>CAL:CURR:SHAR</b>
Check that the short is connected and select Next.	

Step 3. Select the first calibration point. Measure the voltage across the sharing connector and enter the data.

Front Panel Menu Reference	SCPI Command
Display shows: "Enter P1 measured data". Enter the data from the external DVM. This should be about -1 volt. Press Enter when done. Press Back to finish.	<b>CAL:LEV P1</b> <b>*OPC?</b> <b>CAL:DATA &lt;data&gt;</b>

Step 4. After the calibration completes, disconnect the voltmeter and short.

## Resistance Bottom-Out Calibration

This procedure calibrates the minimum voltage that can be achieved while sinking current.

Step 1. Connect an external power supply to the + and - output terminals (see **Cal Setup E**).

Step 2. Set the external supply as follows: Voltage setting =  $(0.9 \text{ V} + 0.08 * \text{rated output voltage of the power supply})$  volts. The voltage must be within 10% of this value. Current limit =  $(0.95 * \text{rated output current of the power supply})$  amps. The current limit must be within 2% of this value.

Step 3. Select the resistance bottom-out calibration. Calibration takes approximately 5 seconds.

Front Panel Menu Reference	SCPI Command
Select <b>System\Admin\Cal\Misc\ResBout</b> . Check that the power supply is connected and select Next.	<b>CAL:RES:BOUT</b> <b>*OPC?</b>

Step 4. After the calibration completes, disconnect the power supply.

## Enter a Calibration Date

Front Panel Menu Reference	SCPI Command
Select <b>System\Admin\Cal\Date</b> . Enter the calibration date in the Date field. If desired, you can enter alphanumeric data in this field.	<b>CAL:DATE "&lt;date&gt;"</b>

## Save Calibration and Log Out

Front Panel Menu Reference	SCPI Command
Select <b>System\Admin\Cal\Save</b> . Select Save.	To save calibration data: <b>CAL:SAVE</b>
Select <b>System\Admin\Logout</b>	To exit calibration mode: <b>CAL:STAT OFF</b>



**N6951A/N6971A**

N6951A/N6971A Test Record		Report Number _____	Date _____	
Test Description	Model	Min. Specs	Results	Max. Specs
Voltage Programming & Readback				
Minimum voltage (Vout):	Both	+ 17 mV	_____	+ 23 mV
Voltage measured over interface:	Both	Vout – 3 mV	_____	Vout + 3 mV
High voltage (Vout):	Both	19.991 V	_____	20.009 V
Voltage measured over interface:	Both	Vout – 9 mV	_____	Vout + 9 mV
CV Load Effect:	Both	– 0.75 mV	_____	+ 0.75 mV
CV Ripple and Noise				
peak-to-peak:	Both	N/A	_____	+ 9 mV
rms:	Both	N/A	_____	+ 1 mV
Transient response @ 100 µs:	Both	– 150 mV	_____	+ 150 mV
Current Programming & Readback				
Minimum current (Iout):	N6951A	– 15 mA	_____	+ 15 mA
	N6971A	– 30 mA	_____	+ 30 mA
Current measured over interface:	N6951A	Iout – 15 mA	_____	Iout + 15 mA
	N6971A	Iout – 30 mA	_____	Iout + 30 mA
High current (Iout):	N6951A	49.935 A	_____	50.065 A
	N6971A	99.87 A	_____	100.13 A
Current measured over interface:	N6951A	Iout – 0.065 A	_____	Iout + 0.065 A
	N6971A	Iout – 0.13 A	_____	Iout + 0.13 A
CC Load Effect:	N6951A	– 3 mA	_____	+ 3 mA
	N6971A	– 6 mA	_____	+ 6 mA
Current Sink Tests				
10% of current rating:	N6951A	– 5.02 A	_____	– 4.98 A
	N6971A	– 10.04 A	_____	– 9.96 A
100% of current rating:	N6951A	– 50.065 A	_____	– 49.935 A
	N6971A	– 100.13 A	_____	– 99.87 A
		<b>N6951A Settings</b>	<b>N6971A Settings</b>	
Voltage Programming & Readback Min:	Voltage priority: 20 mV, 50 A		Voltage priority: 20 mV, 100 A	
Voltage Programming & Readback High:	Voltage priority: 20 V, 50 A		Voltage priority: 20 V, 100 A	
CV Load Effect, CV Ripple and Noise:	Voltage priority: 20 V, 50 A		Voltage priority: 20 V, 100 A	
Transient Response:	Voltage priority: 20 V, 25 A to 50 A		Voltage priority: 20 V, 50 A to 100 A	
Current Programming & Readback Min:	Current priority: 20 V, 0 A		Current priority: 20 V, 0 A	
Current Programming & Readback High:	Current priority: 20 V, 50 A		Current priority: 20 V, 100 A	
CC Load Effect:	Current priority: 20 V, 50 A		Current priority: 20 V, 100 A	
10% of current rating (Isink):	Current priority: 20 V, – 5 A		Current priority: 20 V, – 10 A	
	External supply: 20 V, 5.5 A		External supply: 20 V, 11 A	
100% of current rating (Isink):	Current priority: 20 V, – 50 A		Current priority: 20 V, – 100 A	
	External supply: 20 V, 55 A		External supply: 20 V, 110 A	

**N6952A/N6972A**

N6952A/N6972A Test Record		Report Number _____	Date _____	
Test Description	Model	Min. Specs	Results	Max. Specs
Voltage Programming & Readback				
Minimum voltage (Vout):	Both	+ 34 mV	_____	+ 46 mV
Voltage measured over interface:	Both	Vout – 6 mV	_____	Vout + 6 mV
High voltage (Vout):	Both	39.982 V	_____	40.018 V
Voltage measured over interface:	Both	Vout – 18 mV	_____	Vout + 18 mV
CV Load Effect:	Both	- 1.5 mV	_____	+ 1.5 mV
CV Ripple and Noise				
peak-to-peak:	Both	N/A	_____	+ 9 mV
rms:	Both	N/A	_____	+ 1 mV
Transient response @ 100 µs:	Both	- 100 mV	_____	+ 100 mV
Current Programming & Readback				
Minimum current (Iout):	N6952A	- 8 mA	_____	+ 8 mA
	N6972A	- 15 mA	_____	+ 15 mA
Current measured over interface:	N6952A	Iout – 8 mA	_____	Iout + 8 mA
	N6972A	Iout – 15 mA	_____	Iout + 15 mA
High current (Iout):	N6952A	24.967 A	_____	25.033 A
	N6972A	49.935 A	_____	50.065 A
Current measured over interface:	N6952A	Iout – 0.033 A	_____	Iout + 0.033 A
	N6972A	Iout – 0.065 A	_____	Iout + 0.065 A
CC Load Effect:	N6952A	- 1 mA	_____	+ 1 mA
	N6972A	- 1.5 mA	_____	+ 1.5 mA
Current Sink Tests				
10% of current rating:	N6952A	- 2.5105 A	_____	- 2.4895 A
	N6972A	- 5.02 A	_____	- 4.98 A
100% of current rating:	N6952A	- 25.033 A	_____	- 24.967 A
	N6972A	- 50.065 A	_____	- 49.935 A
		<b>N6952A Settings</b>	<b>N6972A Settings</b>	
Voltage Programming & Readback Min:	Voltage priority: 40 mV, 25 A		Voltage priority: 40 mV, 50 A	
Voltage Programming & Readback High:	Voltage priority: 40 V, 25 A		Voltage priority: 40 V, 50 A	
CV Load Effect, CV Ripple and Noise:	Voltage priority: 40 V, 25 A		Voltage priority: 40 V, 50 A	
Transient Response:	Voltage priority: 40 V, 12.5 A to 25 A		Voltage priority: 40 V, 25 A to 50 A	
Current Programming & Readback Min:	Current priority: 40 V, 0 A		Current priority: 40 V, 0 A	
Current Programming & Readback High:	Current priority: 40 V, 25 A		Current priority: 40 V, 50 A	
CC Load Effect:	Current priority: 40 V, 25 A		Current priority: 40 V, 50 A	
10% of current rating (Isink):	Current priority: 40 V, - 2.5 A		Current priority: 40 V, - 5 A	
	External supply: 40 V, 2.75 A		External supply: 40 V, 5.5 A	
100% of current rating (Isink):	Current priority: 40 V, - 25 A		Current priority: 40 V, - 50 A	
	External supply: 40 V, 27.5 A		External supply: 40 V, 55 A	

**N6953A/N6973A**

N6953A/N6973A Test Record		Report Number _____	Date _____	
Test Description	Model	Min. Specs	Results	Max. Specs
Voltage Programming & Readback				
Minimum voltage (Vout):	Both	+ 51 mV	_____	+ 69 mV
Voltage measured over interface:	Both	Vout – 9 mV	_____	Vout + 9 mV
High voltage (Vout):	Both	59.973 V	_____	60.027 V
Voltage measured over interface:	Both	Vout – 27 mV	_____	Vout + 27 mV
CV Load Effect:	Both	- 2 mV	_____	+ 2 mV
CV Ripple and Noise				
peak-to-peak:	Both	N/A	_____	+ 9 mV
rms:	Both	N/A	_____	+ 1 mV
Transient response @ 100 µs:	Both	- 150 mV	_____	+ 150 mV
Current Programming & Readback				
Minimum current (Iout):	N6953A	- 5 mA	_____	+ 5 mA
	N6973A	- 10 mA	_____	+ 10 mA
Current measured over interface:	N6953A	Iout – 5 mA	_____	Iout + 5 mA
	N6973A	Iout – 10 mA	_____	Iout + 10 mA
High current (Iout):	N6953A	16.6783 A	_____	16.7217 A
	N6973A	33.2567 A	_____	33.3433 A
Current measured over interface:	N6953A	Iout – 0.0217 A	_____	Iout + 0.0217 A
	N6973A	Iout – 0.0433 A	_____	Iout + 0.0433 A
CC Load Effect:	N6953A	- 1 mA	_____	+ 1 mA
	N6973A	- 1.5 mA	_____	+ 1.5 mA
Current Sink Tests				
10% of current rating:	N6953A	- 1.6767 A	_____	- 1.6633 A
	N6973A	- 3.3433 A	_____	- 3.3167 A
100% of current rating:	N6953A	- 16.7217 A	_____	- 16.6783 A
	N6973A	- 33.3433 A	_____	- 33.2567 A
		<b>N6953A Settings</b>	<b>N6973A Settings</b>	
Voltage Programming & Readback Min:	Voltage priority: 60 mV, 16.7 A		Voltage priority: 60 mV, 33.3 A	
Voltage Programming & Readback High:	Voltage priority: 60 V, 16.7 A		Voltage priority: 60 V, 33.3 A	
CV Load Effect, CV Ripple and Noise:	Voltage priority: 60 V, 16.7 A		Voltage priority: 60 V, 33.3 A	
Transient Response:	Voltage priority: 60 V, 8.35 A to 16.7 A		Voltage priority: 60 V, 16.7 A to 33.3 A	
Current Programming & Readback Min:	Current priority: 60 V, 0 A		Current priority: 60 V, 0 A	
Current Programming & Readback High:	Current priority: 60 V, 16.7 A		Current priority: 60 V, 33.3 A	
CC Load Effect:	Current priority: 60 V, 16.7 A		Current priority: 60 V, 33.3 A	
10% of current rating (Isink):	Current priority: 60 V, - 1.67 A		Current priority: 60 V, - 3.33 A	
	External supply: 60 V, 1.837 A		External supply: 60 V, 3.66 A	
100% of current rating (Isink):	Current priority: 60 V, - 16.7 A		Current priority: 60 V, - 33.3 A	
	External supply: 60 V, 18.37 A		External supply: 60 V, 36.6 A	

**N6954A/N6974A**

N6954A/N6974A Test Record		Report Number _____	Date _____	
Test Description	Model	Min. Specs	Results	Max. Specs
Voltage Programming & Readback				
Minimum voltage (Vout):	Both	+ 68 mV	_____	+ 92 mV
Voltage measured over interface:	Both	Vout – 12 mV	_____	Vout + 12 mV
High voltage (Vout):	Both	79.964 V	_____	80.036 V
Voltage measured over interface:	Both	Vout – 36 mV	_____	Vout + 36 mV
CV Load Effect:	Both	- 2 mV	_____	+ 2 mV
CV Ripple and Noise				
peak-to-peak:	Both	N/A	_____	+ 9 mV
rms:	Both	N/A	_____	+ 1 mV
Transient response @ 100 µs:	Both	- 200 mV	_____	+ 200 mV
Current Programming & Readback				
Minimum current (Iout):	N6954A	- 4 mA	_____	+ 4 mA
	N6974A	- 8 mA	_____	+ 8 mA
Current measured over interface:	N6954A	Iout – 4 mA	_____	Iout + 4 mA
	N6974A	Iout – 8 mA	_____	Iout + 8 mA
High current (Iout):	N6954A	12.4835 A	_____	12.5165 A
	N6974A	24.967 A	_____	25.033 A
Current measured over interface:	N6954A	Iout – 0.0165 A	_____	Iout + 0.0165 A
	N6974A	Iout – 0.033 A	_____	Iout + 0.033 A
CC Load Effect:	N6954A	- 0.8 mA	_____	+ 0.8 mA
	N6974A	- 1.5 mA	_____	+ 1.5 mA
Current Sink Tests				
10% of current rating:	N6954A	- 1.2553 A	_____	- 1.2488 A
	N6974A	- 2.5105 A	_____	- 2.4895 A
100% of current rating:	N6954A	- 12.5165 A	_____	- 12.4835 A
	N6974A	- 25.033 A	_____	- 24.967 A
		<b>N6954A Settings</b>	<b>N6974A Settings</b>	
Voltage Programming & Readback Min:	Voltage priority: 80 mV, 12.5 A		Voltage priority: 80 mV, 25 A	
Voltage Programming & Readback High:	Voltage priority: 80 V, 12.5 A		Voltage priority: 80 V, 25 A	
CV Load Effect, CV Ripple and Noise:	Voltage priority: 80 V, 12.5 A		Voltage priority: 80 V, 25 A	
Transient Response:	Voltage priority: 80 V, 6.25 A to 12.5 A		Voltage priority: 80 V, 12.5 A to 25 A	
Current Programming & Readback Min:	Current priority: 80 V, 0 A		Current priority: 80 V, 0 A	
Current Programming & Readback High:	Current priority: 80 V, 12.5 A		Current priority: 80 V, 25 A	
CC Load Effect:	Current priority: 80 V, 12.5 A		Current priority: 80 V, 25 A	
10% of current rating (Isink):	Current priority: 80 V, - 1.25 A		Current priority: 80 V, - 2.5 A	
	External supply: 80 V, 1.375 A		External supply: 80 V, 2.75 A	
100% of current rating (Isink):	Current priority: 80 V, - 12.5 A		Current priority: 80 V, - 25 A	
	External supply: 80 V, 13.75 A		External supply: 80 V, 27.5 A	

## N6950A/N6970A with Option 301

N6950A/N6970A Test Record		Report Number _____	Date _____	
Test Description	Model	Min. Specs	Results	Max. Specs
Voltage Programming & Readback				
Minimum voltage (Vout):	Both	+ 8 mV	_____	+ 10 mV
Voltage measured over interface:	Both	Vout – 1 mV	_____	Vout + 1 mV
High voltage (Vout):	Both	8.9963 V	_____	9.0037 V
Voltage measured over interface:	Both	Vout – 3.7 mV	_____	Vout + 3.7 mV
CV Load Effect:	Both	– 0.5 mV	_____	+ 0.5 mV
CV Ripple and Noise				
peak-to-peak:	Both	N/A	_____	+ 9 mV
rms:	Both	N/A	_____	+ 1 mV
Transient response @ 100 µs:	Both	– 150 mV	_____	+ 150 mV
Current Programming & Readback				
Minimum current (Iout):	N6950A	– 15 mA	_____	+ 15 mA
	N6970A	– 30 mA	_____	+ 30 mA
Current measured over interface:	N6950A	Iout – 15 mA	_____	Iout + 15 mA
	N6970A	Iout – 30 mA	_____	Iout + 30 mA
High current (Iout):	N6950A	99.945 A	_____	100.055 A
	N6970A	199.89 A	_____	200.11 A
Current measured over interface:	N6950A	Iout – 0.055 A	_____	Iout + 0.055 A
	N6970A	Iout – 0.11 A	_____	Iout + 0.11 A
Low Current Measurement Range:	N6950A	Iout – 0.008 A	_____	Iout + 0.008 A
	N6970A	Iout – 0.016 A	_____	Iout + 0.016 A
CC Load Effect:	N6950A	– 8 mA	_____	+ 8 mA
	N6970A	– 15 mA	_____	+ 15 mA
Current Sink Tests				
10% of current rating:	N6950A	– 10.019 A	_____	– 9.981 A
	N6970A	– 20.038 A	_____	– 19.962 A
100% of current rating:	N6950A	– 100.055 A	_____	– 99.945 A
	N6970A	– 200.11 A	_____	– 199.89 A
		N6950ASettings	N6970ASettings	
Voltage Programming & Readback Min:	Voltage priority: 9 mV, 100 A		Voltage priority: 9 mV, 200 A	
Voltage Programming & Readback High:	Voltage priority: 9 V, 100 A		Voltage priority: 9 V, 200 A	
CV Load Effect, CV Ripple and Noise:	Voltage priority: 9 V, 100 A		Voltage priority: 9 V, 200 A	
Transient Response:	Voltage priority: 9 V, 50 A to 100 A		Voltage priority: 9 V, 100 A to 200 A	
Current Programming & Readback Min:	Current priority: 9 V, 0 A		Current priority: 9 V, 0 A	
Current Programming & Readback High:	Current priority: 9 V, 100 A		Current priority: 9 V, 200 A	
Low Current Measurement Range:	Current priority: 9 V, 10 A		Current priority: 9 V, 20 A	
CC Load Effect:	Current priority: 9 V, 100 A		Current priority: 9 V, 200 A	
10% of current rating (Isink):	Current priority: 9 V, – 10 A		Current priority: 9 V, – 20 A	
	External supply: 9 V, 11 A		External supply: 9 V, 22 A	
100% of current rating (Isink):	Current priority: 9 V, – 100 A		Current priority: 9 V, – 200 A	
	External supply: 9 V, 110 A		External supply: 9 V, 220 A	

**N6951A/N6971A with Option 301**

N6951A/N6971A Test Record		Report Number _____	Date _____	
Test Description	Model	Min. Specs	Results	Max. Specs
Voltage Programming & Readback				
Minimum voltage (Vout):	Both	+ 18 mV	_____	+ 22 mV
Voltage measured over interface:	Both	Vout – 2 mV	_____	Vout + 2 mV
High voltage (Vout):	Both	19.992 V	_____	20.008 V
Voltage measured over interface:	Both	Vout – 8 mV	_____	Vout + 8 mV
CV Load Effect:	Both	– 0.75 mV	_____	+ 0.75 mV
CV Ripple and Noise				
peak-to-peak:	Both	N/A	_____	+ 9 mV
rms:	Both	N/A	_____	+ 1 mV
Transient response @ 100 µs:	Both	– 150 mV	_____	+ 150 mV
Current Programming & Readback				
Minimum current (Iout):	N6951A	– 8 mA	_____	+ 8 mA
	N6971A	– 15 mA	_____	+ 15 mA
Current measured over interface:	N6951A	Iout – 8 mA	_____	Iout + 8 mA
	N6971A	Iout – 15 mA	_____	Iout + 15 mA
High current (Iout):	N6951A	49.972 A	_____	50.028 A
	N6971A	99.945 A	_____	100.055 A
Current measured over interface:	N6951A	Iout – 0.028 A	_____	Iout + 0.028 A
	N6971A	Iout – 0.055 A	_____	Iout + 0.055 A
Low Current Measurement Range:	N6951A	Iout – 0.0035 A	_____	Iout + 0.0035 A
	N6971A	Iout – 0.007 A	_____	Iout + 0.007 A
CC Load Effect:	N6951A	– 3 mA	_____	+ 3 mA
	N6971A	– 6 mA	_____	+ 6 mA
Current Sink Tests				
10% of current rating:	N6951A	– 5.01 A	_____	– 4.99 A
	N6971A	– 10.019 A	_____	– 9.981 A
100% of current rating:	N6951A	– 50.028 A	_____	– 49.972 A
	N6971A	– 100.055 A	_____	– 99.945 A
		<b>N6951ASettings</b>	<b>N6971ASettings</b>	
Voltage Programming & Readback Min:	Voltage priority: 20 mV, 50 A		Voltage priority: 20 mV, 100 A	
Voltage Programming & Readback High:	Voltage priority: 20 V, 50 A		Voltage priority: 20 V, 100 A	
CV Load Effect, CV Ripple and Noise:	Voltage priority: 20 V, 50 A		Voltage priority: 20 V, 100 A	
Transient Response:	Voltage priority: 20 V, 25 A to 50 A		Voltage priority: 20 V, 50 A to 100 A	
Current Programming & Readback Min:	Current priority: 20 V, 0 A		Current priority: 20 V, 0 A	
Current Programming & Readback High:	Current priority: 20 V, 50 A		Current priority: 20 V, 100 A	
Low Current Measurement Range:	Current priority: 20 V, 5 A		Current priority: 20 V, 10 A	
CC Load Effect:	Current priority: 20 V, 50 A		Current priority: 20 V, 100 A	
10% of current rating (Isink):	Current priority: 20 V, – 5 A		Current priority: 20 V, – 10 A	
	External supply: 20 V, 5.5 A		External supply: 20 V, 11 A	
100% of current rating (Isink):	Current priority: 20 V, – 50 A		Current priority: 20 V, – 100 A	
	External supply: 20 V, 55 A		External supply: 20 V, 110 A	

## N6952A/N6972A with Option 301

N6952A/N6972A Test Record		Report Number _____	Date _____	
Test Description	Model	Min. Specs	Results	Max. Specs
Voltage Programming & Readback				
Minimum voltage (Vout):	Both	+ 36 mV	_____	+ 44 mV
Voltage measured over interface:	Both	Vout – 4 mV	_____	Vout + 4 mV
High voltage (Vout):	Both	39.984 V	_____	40.016 V
Voltage measured over interface:	Both	Vout – 16 mV	_____	Vout + 16 mV
CV Load Effect:	Both	– 1.5 mV	_____	+ 1.5 mV
CV Ripple and Noise				
peak-to-peak:	Both	N/A	_____	+ 9 mV
rms:	Both	N/A	_____	+ 1 mV
Transient response @ 100 µs:	Both	– 100 mV	_____	+ 100 mV
Current Programming & Readback				
Minimum current (Iout):	N6952A	– 4 mA	_____	+ 4 mA
	N6972A	– 8 mA	_____	+ 8 mA
Current measured over interface:	N6952A	Iout – 4 mA	_____	Iout + 4 mA
	N6972A	Iout – 8 mA	_____	Iout + 8 mA
High current (Iout):	N6952A	24.986 A	_____	25.014 A
	N6972A	49.972 A	_____	50.028 A
Current measured over interface:	N6952A	Iout – 0.014 A	_____	Iout + 0.014 A
	N6972A	Iout – 0.028 A	_____	Iout + 0.028 A
Low Current Measurement Range:	N6952A	Iout – 0.0019 A	_____	Iout + 0.0019 A
	N6972A	Iout – 0.0037 A	_____	Iout + 0.0037 A
CC Load Effect:	N6952A	– 1 mA	_____	+ 1 mA
	N6972A	– 1.5 mA	_____	+ 1.5 mA
Current Sink Tests				
10% of current rating:	N6952A	– 2.505 A	_____	– 2.495 A
	N6972A	– 5.01 A	_____	– 4.99 A
100% of current rating:	N6952A	– 25.014 A	_____	– 24.986 A
	N6972A	– 50.028 A	_____	– 49.972 A
		<b>N6952ASettings</b>	<b>N6972ASettings</b>	
Voltage Programming & Readback Min:	Voltage priority: 40 mV, 25 A		Voltage priority: 40 mV, 50 A	
Voltage Programming & Readback High:	Voltage priority: 40 V, 25 A		Voltage priority: 40 V, 50 A	
CV Load Effect, CV Ripple and Noise:	Voltage priority: 40 V, 25 A		Voltage priority: 40 V, 50 A	
Transient Response:	Voltage priority: 40 V, 12.5 A to 25 A		Voltage priority: 40 V, 25 A to 50 A	
Current Programming & Readback Min:	Current priority: 40 V, 0 A		Current priority: 40 V, 0 A	
Current Programming & Readback High:	Current priority: 40 V, 25 A		Current priority: 40 V, 50 A	
Low Current Measurement Range:	Current priority: 40 V, 2.5 A		Current priority: 40 V, 5 A	
CC Load Effect:	Current priority: 40 V, 25 A		Current priority: 40 V, 50 A	
10% of current rating (Isink):	Current priority: 40 V, – 2.5 A		Current priority: 40 V, – 5 A	
	External supply: 40 V, 2.75 A		External supply: 40 V, 5.5 A	
100% of current rating (Isink):	Current priority: 40 V, – 25 A		Current priority: 40 V, – 50 A	
	External supply: 40 V, 27.5 A		External supply: 40 V, 55 A	

**N6953A/N6973A with Option 301**

N6953A/N6973A Test Record		Report Number _____	Date _____	
Test Description	Model	Min. Specs	Results	Max. Specs
Voltage Programming & Readback				
Minimum voltage (Vout):	Both	+ 54 mV	_____	+ 66 mV
Voltage measured over interface:	Both	Vout – 6 mV	_____	Vout + 6 mV
High voltage (Vout):	Both	59.976 V	_____	60.024 V
Voltage measured over interface:	Both	Vout – 24 mV	_____	Vout + 24 mV
CV Load Effect:	Both	- 2 mV	_____	+ 2 mV
CV Ripple and Noise				
peak-to-peak:	Both	N/A	_____	+ 9 mV
rms:	Both	N/A	_____	+ 1 mV
Transient response @ 100 µs:	Both	- 150 mV	_____	+ 150 mV
Current Programming & Readback				
Minimum current (Iout):	N6953A	- 2.5 mA	_____	+ 2.5 mA
	N6973A	- 5 mA	_____	+ 5 mA
Current measured over interface:	N6953A	Iout – 2.5 mA	_____	Iout + 2.5 mA
	N6973A	Iout – 5 mA	_____	Iout + 5 mA
High current (Iout):	N6953A	16.6908 A	_____	16.7092 A
	N6973A	33.2817 A	_____	33.3183 A
Current measured over interface:	N6953A	Iout – 0.0092 A	_____	Iout + 0.0092 A
	N6973A	Iout – 0.0183 A	_____	Iout + 0.0183 A
Low Current Measurement Range:	N6953A	Iout – 0.0011 A	_____	Iout + 0.0011 A
	N6973A	Iout – 0.0023 A	_____	Iout + 0.0023 A
CC Load Effect:	N6953A	- 1 mA	_____	+ 1 mA
	N6973A	- 1.5 mA	_____	+ 1.5 mA
Current Sink Tests				
10% of current rating:	N6953A	- 1.6732 A	_____	- 1.6668 A
	N6973A	- 3.3363 A	_____	- 3.3237 A
100% of current rating:	N6953A	- 16.7092 A	_____	- 16.6908 A
	N6973A	- 33.3183 A	_____	- 33.2817 A
		<b>N6953ASettings</b>	<b>N6973ASettings</b>	
Voltage Programming & Readback Min:	Voltage priority: 60 mV, 16.7 A		Voltage priority: 60 mV, 33.3 A	
Voltage Programming & Readback High:	Voltage priority: 60 V, 16.7 A		Voltage priority: 60 V, 33.3 A	
CV Load Effect, CV Ripple and Noise:	Voltage priority: 60 V, 16.7 A		Voltage priority: 60 V, 33.3 A	
Transient Response:	Voltage priority: 60 V, 8.35 A to 16.7 A		Voltage priority: 60 V, 16.7 A to 33.3 A	
Current Programming & Readback Min:	Current priority: 60 V, 0 A		Current priority: 60 V, 0 A	
Current Programming & Readback High:	Current priority: 60 V, 16.7 A		Current priority: 60 V, 33.3 A	
Low Current Measurement Range:	Current priority: 60 V, 1.67 A		Current priority: 60 V, 3.33 A	
CC Load Effect:	Current priority: 60 V, 16.7 A		Current priority: 60 V, 33.3 A	
10% of current rating (Isink):	Current priority: 60 V, - 1.67 A		Current priority: 60 V, - 3.33 A	
	External supply: 60 V, 1.837 A		External supply: 60 V, 3.66 A	
100% of current rating (Isink):	Current priority: 60 V, - 16.7 A		Current priority: 60 V, - 33.3 A	
	External supply: 60 V, 18.37 A		External supply: 60 V, 36.6 A	

## N6954A/N6974A with Option 301

N6954A/N6974A Test Record		Report Number _____	Date _____	
Test Description	Model	Min. Specs	Results	Max. Specs
Voltage Programming & Readback				
Minimum voltage (Vout):	Both	+ 72 mV	_____	+ 88 mV
Voltage measured over interface:	Both	Vout – 8 mV	_____	Vout + 8 mV
High voltage (Vout):	Both	79.968 V	_____	80.032 V
Voltage measured over interface:	Both	Vout – 32 mV	_____	Vout + 32 mV
CV Load Effect:	Both	- 2 mV	_____	+ 2 mV
CV Ripple and Noise				
peak-to-peak:	Both	N/A	_____	+ 9 mV
rms:	Both	N/A	_____	+ 1 mV
Transient response @ 100 µs:	Both	- 200 mV	_____	+ 200 mV
Current Programming & Readback				
Minimum current (Iout):	N6954A	- 2 mA	_____	+ 2 mA
	N6974A	- 4 mA	_____	+ 4 mA
Current measured over interface:	N6954A	Iout – 2 mA	_____	Iout + 2 mA
	N6974A	Iout – 4 mA	_____	Iout + 4 mA
High current (Iout):	N6954A	12.493 A	_____	12.507 A
	N6974A	24.986 A	_____	25.014 A
Current measured over interface:	N6954A	Iout – 0.007 A	_____	Iout + 0.007 A
	N6974A	Iout – 0.014 A	_____	Iout + 0.014 A
Low Current Measurement Range:	N6954A	Iout – 0.000875 A	_____	Iout + 0.000875 A
	N6974A	Iout – 0.0018 A	_____	Iout + 0.0018 A
CC Load Effect:	N6954A	- 0.8 mA	_____	+ 0.8 mA
	N6974A	- 1.5 mA	_____	+ 1.5 mA
Current Sink Tests				
10% of current rating:	N6954A	- 1.2525 A	_____	- 1.2475 A
	N6974A	- 2.505 A	_____	- 2.495 A
100% of current rating:	N6954A	- 12.507 A	_____	- 12.493 A
	N6974A	- 25.014 A	_____	- 24.986 A
		<b>N6954ASettings</b>	<b>N6974ASettings</b>	
Voltage Programming & Readback Min:	Voltage priority: 80 mV, 12.5 A		Voltage priority: 80 mV, 25 A	
Voltage Programming & Readback High:	Voltage priority: 80 V, 12.5 A		Voltage priority: 80 V, 25 A	
CV Load Effect, CV Ripple and Noise:	Voltage priority: 80 V, 12.5 A		Voltage priority: 80 V, 25 A	
Transient Response:	Voltage priority: 80 V, 6.25 A to 12.5 A		Voltage priority: 80 V, 12.5 A to 25 A	
Current Programming & Readback Min:	Current priority: 80 V, 0 A		Current priority: 80 V, 0 A	
Current Programming & Readback High:	Current priority: 80 V, 12.5 A		Current priority: 80 V, 25 A	
Low Current Measurement Range:	Current priority: 80 V, 1.25 A		Current priority: 80 V, 2.5 A	
CC Load Effect:	Current priority: 80 V, 12.5 A		Current priority: 80 V, 25 A	
10% of current rating (Isink):	Current priority: 80 V, - 1.25 A		Current priority: 80 V, - 2.5 A	
	External supply: 80 V, 1.375 A		External supply: 80 V, 2.75 A	
100% of current rating (Isink):	Current priority: 80 V, - 12.5 A		Current priority: 80 V, - 25 A	
	External supply: 80 V, 13.75 A		External supply: 80 V, 27.5 A	

**N7950A/N7970A**

N7950A/N7970A Test Record		Report Number _____	Date _____	
Test Description	Model	Min. Specs	Results	Max. Specs
Voltage Programming & Readback				
Minimum voltage (Vout):	Both	+ 8 mV	_____	+ 10 mV
Voltage measured over interface:	Both	Vout – 1 mV	_____	Vout + 1 mV
High voltage (Vout):	Both	8.9963 V	_____	9.0037 V
Voltage measured over interface:	Both	Vout – 3.7 mV	_____	Vout + 3.7 mV
CV Load Effect:	Both	– 0.5 mV	_____	+ 0.5 mV
CV Ripple and Noise				
peak-to-peak:	Both	N/A	_____	+ 9 mV
rms:	Both	N/A	_____	+ 1 mV
Transient response @ 100 µs:	Both	– 150 mV	_____	+ 150 mV
Current Programming & Readback				
Minimum current (Iout):	N7950A	– 15 mA	_____	+ 15 mA
	N7970A	– 30 mA	_____	+ 30 mA
Current measured over interface:	N7950A	Iout – 15 mA	_____	Iout + 15 mA
	N7970A	Iout – 30 mA	_____	Iout + 30 mA
High current (Iout):	N7950A	99.945 A	_____	100.055 A
	N7970A	199.89 A	_____	200.11 A
Current measured over interface:	N7950A	Iout – 0.055 A	_____	Iout + 0.055 A
	N7970A	Iout – 0.11 A	_____	Iout + 0.11 A
Low Current Measurement Range:	N7950A	Iout – 0.008 A	_____	Iout + 0.008 A
	N7970A	Iout – 0.016 A	_____	Iout + 0.016 A
CC Load Effect:	N7950A	– 8 mA	_____	+ 8 mA
	N7970A	– 15 mA	_____	+ 15 mA
Current Sink Tests				
10% of current rating:	N7950A	– 10.019 A	_____	– 9.981 A
	N7970A	– 20.038 A	_____	– 19.962 A
100% of current rating:	N7950A	– 100.055 A	_____	– 99.945 A
	N7970A	– 200.11 A	_____	– 199.89 A
		<b>N7950A Settings</b>	<b>N7970A Settings</b>	
Voltage Programming & Readback Min:		Voltage priority: 9 mV, 100 A		Voltage priority: 9 mV, 200 A
Voltage Programming & Readback High:		Voltage priority: 9 V, 100 A		Voltage priority: 9 V, 200 A
CV Load Effect, CV Ripple and Noise:		Voltage priority: 9 V, 100 A		Voltage priority: 9 V, 200 A
Transient Response:		Voltage priority: 9 V, 50 A to 100 A		Voltage priority: 9 V, 100 A to 200 A
Current Programming & Readback Min:		Current priority: 9 V, 0 A		Current priority: 9 V, 0 A
Current Programming & Readback High:		Current priority: 9 V, 100 A		Current priority: 9 V, 200 A
Low Current Measurement Range:		Current priority: 9 V, 10 A		Current priority: 9 V, 20 A
CC Load Effect:		Current priority: 9 V, 100 A		Current priority: 9 V, 200 A
10% of current rating (Isink):		Current priority: 9 V, – 10 A		Current priority: 9 V, – 20 A
		External supply: 9 V, 11 A		External supply: 9 V, 22 A
100% of current rating (Isink):		Current priority: 9 V, – 100 A		Current priority: 9 V, – 200 A
		External supply: 9 V, 110 A		External supply: 9 V, 220 A

**N7951A/N7971A**

N7951A/N7971A Test Record		Report Number _____	Date _____	
Test Description	Model	Min. Specs	Results	Max. Specs
Voltage Programming & Readback				
Minimum voltage (Vout):	Both	+ 18 mV	_____	+ 22 mV
Voltage measured over interface:	Both	Vout – 2 mV	_____	Vout + 2 mV
High voltage (Vout):	Both	19.992 V	_____	20.008 V
Voltage measured over interface:	Both	Vout – 8 mV	_____	Vout + 8 mV
CV Load Effect:	Both	– 0.75 mV	_____	+ 0.75 mV
CV Ripple and Noise				
peak-to-peak:	Both	N/A	_____	+ 9 mV
rms:	Both	N/A	_____	+ 1 mV
Transient response @ 100 µs:	Both	– 150 mV	_____	+ 150 mV
Current Programming & Readback				
Minimum current (Iout):	N7951A	– 8 mA	_____	+ 8 mA
	N7971A	– 15 mA	_____	+ 15 mA
Current measured over interface:	N7951A	Iout – 8 mA	_____	Iout + 8 mA
	N7971A	Iout – 15 mA	_____	Iout + 15 mA
High current (Iout):	N7951A	49.972 A	_____	50.028 A
	N7971A	99.945 A	_____	100.055 A
Current measured over interface:	N7951A	Iout – 0.028 A	_____	Iout + 0.028 A
	N7971A	Iout – 0.055 A	_____	Iout + 0.055 A
Low Current Measurement Range:	N7951A	Iout – 0.0035 A	_____	Iout + 0.0035 A
	N7971A	Iout – 0.007 A	_____	Iout + 0.007 A
CC Load Effect:	N7951A	– 3 mA	_____	+ 3 mA
	N7971A	– 6 mA	_____	+ 6 mA
Current Sink Tests				
10% of current rating:	N7951A	– 5.01 A	_____	– 4.99 A
	N7971A	– 10.019 A	_____	– 9.981 A
100% of current rating:	N7951A	– 50.028 A	_____	– 49.972 A
	N7971A	– 100.055 A	_____	– 99.945 A
	<b>N7951A Settings</b>		<b>N7971A Settings</b>	
Voltage Programming & Readback Min:	Voltage priority: 20 mV, 50 A		Voltage priority: 20 mV, 100 A	
Voltage Programming & Readback High:	Voltage priority: 20 V, 50 A		Voltage priority: 20 V, 100 A	
CV Load Effect, CV Ripple and Noise:	Voltage priority: 20 V, 50 A		Voltage priority: 20 V, 100 A	
Transient Response:	Voltage priority: 20 V, 25 A to 50 A		Voltage priority: 20 V, 50 A to 100 A	
Current Programming & Readback Min:	Current priority: 20 V, 0 A		Current priority: 20 V, 0 A	
Current Programming & Readback High:	Current priority: 20 V, 50 A		Current priority: 20 V, 100 A	
Low Current Measurement Range:	Current priority: 20 V, 5 A		Current priority: 20 V, 10 A	
CC Load Effect:	Current priority: 20 V, 50 A		Current priority: 20 V, 100 A	
10% of current rating (Isink):	Current priority: 20 V, – 5 A		Current priority: 20 V, – 10 A	
	External supply: 20 V, 5.5 A		External supply: 20 V, 11 A	
100% of current rating (Isink):	Current priority: 20 V, – 50 A		Current priority: 20 V, – 100 A	
	External supply: 20 V, 55 A		External supply: 20 V, 110 A	

**N7952A/N7972A**

N7952A/N7972A Test Record		Report Number _____	Date _____	
Test Description	Model	Min. Specs	Results	Max. Specs
Voltage Programming & Readback				
Minimum voltage (Vout):	Both	+ 36 mV	_____	+ 44 mV
Voltage measured over interface:	Both	Vout – 4 mV	_____	Vout + 4 mV
High voltage (Vout):	Both	39.984 V	_____	40.016 V
Voltage measured over interface:	Both	Vout – 16 mV	_____	Vout + 16 mV
CV Load Effect:	Both	– 1.5 mV	_____	+ 1.5 mV
CV Ripple and Noise				
peak-to-peak:	Both	N/A	_____	+ 9 mV
rms:	Both	N/A	_____	+ 1 mV
Transient response @ 100 µs:	Both	– 100 mV	_____	+ 100 mV
Current Programming & Readback				
Minimum current (Iout):	N7952A	– 4 mA	_____	+ 4 mA
	N7972A	– 8 mA	_____	+ 8 mA
Current measured over interface:	N7952A	Iout – 4 mA	_____	Iout + 4 mA
	N7972A	Iout – 8 mA	_____	Iout + 8 mA
High current (Iout):	N7952A	24.986 A	_____	25.014 A
	N7972A	49.972 A	_____	50.028 A
Current measured over interface:	N7952A	Iout – 0.014 A	_____	Iout + 0.014 A
	N7972A	Iout – 0.028 A	_____	Iout + 0.028 A
Low Current Measurement Range:	N7952A	Iout – 0.0019 A	_____	Iout + 0.0019 A
	N7972A	Iout – 0.0037 A	_____	Iout + 0.0037 A
CC Load Effect:	N7952A	– 1 mA	_____	+ 1 mA
	N7972A	– 1.5 mA	_____	+ 1.5 mA
Current Sink Tests				
10% of current rating:	N7952A	– 2.505 A	_____	– 2.495 A
	N7972A	– 5.01 A	_____	– 4.99 A
100% of current rating:	N7952A	– 25.014 A	_____	– 24.986 A
	N7972A	– 50.028 A	_____	– 49.972 A
	<b>N7952A Settings</b>			<b>N7972A Settings</b>
Voltage Programming & Readback Min:	Voltage priority: 40 mV, 25 A			Voltage priority: 40 mV, 50 A
Voltage Programming & Readback High:	Voltage priority: 40 V, 25 A			Voltage priority: 40 V, 50 A
CV Load Effect, CV Ripple and Noise:	Voltage priority: 40 V, 25 A			Voltage priority: 40 V, 50 A
Transient Response:	Voltage priority: 40 V, 12.5 A to 25 A			Voltage priority: 40 V, 25 A to 50 A
Current Programming & Readback Min:	Current priority: 40 V, 0 A			Current priority: 40 V, 0 A
Current Programming & Readback High:	Current priority: 40 V, 25 A			Current priority: 40 V, 50 A
Low Current Measurement Range:	Current priority: 40 V, 2.5 A			Current priority: 40 V, 5 A
CC Load Effect:	Current priority: 40 V, 25 A			Current priority: 40 V, 50 A
10% of current rating (Isink):	Current priority: 40 V, – 2.5 A			Current priority: 40 V, – 5 A
	External supply: 40 V, 2.75 A			External supply: 40 V, 5.5 A
100% of current rating (Isink):	Current priority: 40 V, – 25 A			Current priority: 40 V, – 50 A
	External supply: 40 V, 27.5 A			External supply: 40 V, 55 A

**N7953A/N7973A**

N7953A/N7973A Test Record		Report Number _____	Date _____	
Test Description	Model	Min. Specs	Results	Max. Specs
Voltage Programming & Readback				
Minimum voltage (Vout):	Both	+ 54 mV	_____	+ 66 mV
Voltage measured over interface:	Both	Vout – 6 mV	_____	Vout + 6 mV
High voltage (Vout):	Both	59.976 V	_____	60.024 V
Voltage measured over interface:	Both	Vout – 24 mV	_____	Vout + 24 mV
CV Load Effect:	Both	- 2 mV	_____	+ 2 mV
CV Ripple and Noise				
peak-to-peak:	Both	N/A	_____	+ 9 mV
rms:	Both	N/A	_____	+ 1 mV
Transient response @ 100 µs:	Both	- 150 mV	_____	+ 150 mV
Current Programming & Readback				
Minimum current (Iout):	N7953A	- 2.5 mA	_____	+ 2.5 mA
	N7973A	- 5 mA	_____	+ 5 mA
Current measured over interface:	N7953A	Iout – 2.5 mA	_____	Iout + 2.5 mA
	N7973A	Iout – 5 mA	_____	Iout + 5 mA
High current (Iout):	N7953A	16.6908 A	_____	16.7092 A
	N7973A	33.2817 A	_____	33.3183 A
Current measured over interface:	N7953A	Iout – 0.0092 A	_____	Iout + 0.0092 A
	N7973A	Iout – 0.0183 A	_____	Iout + 0.0183 A
Low Current Measurement Range:	N7953A	Iout – 0.0011 A	_____	Iout + 0.0011 A
	N7973A	Iout – 0.0023 A	_____	Iout + 0.0023 A
CC Load Effect:	N7953A	- 1 mA	_____	+ 1 mA
	N7973A	- 1.5 mA	_____	+ 1.5 mA
Current Sink Tests				
10% of current rating:	N7953A	- 1.6732 A	_____	- 1.6668 A
	N7973A	- 3.3363 A	_____	- 3.3237 A
100% of current rating:	N7953A	- 16.7092 A	_____	- 16.6908 A
	N7973A	- 33.3183 A	_____	- 33.2817 A
		<b>N7953A Settings</b>	<b>N7973A Settings</b>	
Voltage Programming & Readback Min:	Voltage priority: 60 mV, 16.7 A		Voltage priority: 60 mV, 33.3 A	
Voltage Programming & Readback High:	Voltage priority: 60 V, 16.7 A		Voltage priority: 60 V, 33.3 A	
CV Load Effect, CV Ripple and Noise:	Voltage priority: 60 V, 16.7 A		Voltage priority: 60 V, 33.3 A	
Transient Response:	Voltage priority: 60 V, 8.35 A to 16.7 A		Voltage priority: 60 V, 16.7 A to 33.3 A	
Current Programming & Readback Min:	Current priority: 60 V, 0 A		Current priority: 60 V, 0 A	
Current Programming & Readback High:	Current priority: 60 V, 16.7 A		Current priority: 60 V, 33.3 A	
Low Current Measurement Range:	Current priority: 60 V, 1.67 A		Current priority: 60 V, 3.33 A	
CC Load Effect:	Current priority: 60 V, 16.7 A		Current priority: 60 V, 33.3 A	
10% of current rating (Isink):	Current priority: 60 V, - 1.67 A		Current priority: 60 V, - 3.33 A	
	External supply: 60 V, 1.837 A		External supply: 60 V, 3.66 A	
100% of current rating (Isink):	Current priority: 60 V, - 16.7 A		Current priority: 60 V, - 33.3 A	
	External supply: 60 V, 18.37 A		External supply: 60 V, 36.6 A	

**N7954A/N7974A**

N7954A/N7974A Test Record		Report Number _____	Date _____	
Test Description	Model	Min. Specs	Results	Max. Specs
Voltage Programming & Readback				
Minimum voltage (Vout):	Both	+ 72 mV	_____	+ 88 mV
Voltage measured over interface:	Both	Vout – 8 mV	_____	Vout + 8 mV
High voltage (Vout):	Both	79.968 V	_____	80.032 V
Voltage measured over interface:	Both	Vout – 32 mV	_____	Vout + 32 mV
CV Load Effect:	Both	- 2 mV	_____	+ 2 mV
CV Ripple and Noise				
peak-to-peak:	Both	N/A	_____	+ 9 mV
rms:	Both	N/A	_____	+ 1 mV
Transient response @ 100 µs:	Both	- 200 mV	_____	+ 200 mV
Current Programming & Readback				
Minimum current (Iout):	N7954A	- 2 mA	_____	+ 2 mA
	N7974A	- 4 mA	_____	+ 4 mA
Current measured over interface:	N7954A	Iout – 2 mA	_____	Iout + 2 mA
	N7974A	Iout – 4 mA	_____	Iout + 4 mA
High current (Iout):	N7954A	12.493 A	_____	12.507 A
	N7974A	24.986 A	_____	25.014 A
Current measured over interface:	N7954A	Iout – 0.007 A	_____	Iout + 0.007 A
	N7974A	Iout – 0.014 A	_____	Iout + 0.014 A
Low Current Measurement Range:	N7954A	Iout – 0.000875 A	_____	Iout + 0.000875 A
	N7974A	Iout – 0.0018 A	_____	Iout + 0.0018 A
CC Load Effect:	N7954A	- 0.8 mA	_____	+ 0.8 mA
	N7974A	- 1.5 mA	_____	+ 1.5 mA
Current Sink Tests				
10% of current rating:	N7954A	- 1.2525 A	_____	- 1.2475 A
	N7974A	- 2.505 A	_____	- 2.495 A
100% of current rating:	N7954A	- 12.507 A	_____	- 12.493 A
	N7974A	- 25.014 A	_____	- 24.986 A
		<b>N7954A Settings</b>	<b>N7974A Settings</b>	
Voltage Programming & Readback Min:	Voltage priority: 80 mV, 12.5 A		Voltage priority: 80 mV, 25 A	
Voltage Programming & Readback High:	Voltage priority: 80 V, 12.5 A		Voltage priority: 80 V, 25 A	
CV Load Effect, CV Ripple and Noise:	Voltage priority: 80 V, 12.5 A		Voltage priority: 80 V, 25 A	
Transient Response:	Voltage priority: 80 V, 6.25 A to 12.5 A		Voltage priority: 80 V, 12.5 A to 25 A	
Current Programming & Readback Min:	Current priority: 80 V, 0 A		Current priority: 80 V, 0 A	
Current Programming & Readback High:	Current priority: 80 V, 12.5 A		Current priority: 80 V, 25 A	
Low Current Measurement Range:	Current priority: 80 V, 1.25 A		Current priority: 80 V, 2.5 A	
CC Load Effect:	Current priority: 80 V, 12.5 A		Current priority: 80 V, 25 A	
10% of current rating (Isink):	Current priority: 80 V, - 1.25 A		Current priority: 80 V, - 2.5 A	
	External supply: 80 V, 1.375 A		External supply: 80 V, 2.75 A	
100% of current rating (Isink):	Current priority: 80 V, - 12.5 A		Current priority: 80 V, - 25 A	
	External supply: 80 V, 13.75 A		External supply: 80 V, 27.5 A	

**N6976A**

N6976A Test Record		Report Number _____	Date _____	
Test Description	Model	Min. Specs	Results	Max. Specs
Voltage Programming & Readback				
Minimum voltage (Vout):		+ 103 mV	_____	+ 137 mV
Voltage measured over interface:		Vout - 17 mV	_____	Vout + 17 mV
High voltage (Vout):		119.947 V	_____	120.053 V
Voltage measured over interface:		Vout - 53 mV	_____	Vout + 53 mV
CV Load Effect:				
		- 4 mV	_____	+ 4 mV
CV Ripple and Noise				
peak-to-peak:		N/A	_____	+ 9 mV
rms:		N/A	_____	+ 1 mV
Transient response @ 100 µs:				
		- 300 mV	_____	+ 300 mV
Current Programming & Readback				
Minimum current (Iout):		- 5 mA	_____	+ 5 mA
Current measured over interface:		Iout - 5 mA	_____	Iout + 5 mA
High current (Iout):		16.6783 A	_____	16.7217 A
Current measured over interface:		Iout - 0.0217 A	_____	Iout + 0.0217 A
CC Load Effect:				
		- 1 mA	_____	+ 1 mA
Current Sink Tests				
10% of current rating:		- 1.6767 A	_____	- 1.6633 A
100% of current rating:		- 16.7217 A	_____	- 16.6783 A

**N6976A Settings**

Voltage Programming & Readback Min:	Voltage priority: 120 mV, 16.7 A
Voltage Programming & Readback High:	Voltage priority: 120 V, 16.7 A
CV Load Effect, CV Ripple and Noise:	Voltage priority: 120 V, 16.7 A
Transient Response:	Voltage priority: 120 V, 8.35 A to 16.7 A
Current Programming & Readback Min:	Current priority: 120 V, 0 A
Current Programming & Readback High:	Current priority: 120 V, 16.7 A
CC Load Effect:	Current priority: 120 V, 16.7 A
10% of current rating (Isink):	Current priority: 120 V, - 1.67 A
	External supply: 120 V, 1.837 A
100% of current rating (Isink):	Current priority: 120 V, - 16.7 A
	External supply: 120 V, 18.37 A

**N6977A**

N6977A Test Record		Report Number _____	Date _____	
Test Description	Model	Min. Specs	Results	Max. Specs
Voltage Programming & Readback				
Minimum voltage (Vout):		+ 136 mV	_____	+ 184 mV
Voltage measured over interface:		Vout - 24 mV	_____	Vout + 24 mV
High voltage (Vout):		159.928 V	_____	160.072 V
Voltage measured over interface:		Vout - 72 mV	_____	Vout + 72 mV
CV Load Effect:				
		- 4 mV	_____	+ 4 mV
CV Ripple and Noise				
peak-to-peak:		N/A	_____	+ 9 mV
rms:		N/A	_____	+ 1 mV
Transient response @ 100 $\mu$ s:				
		- 400 mV	_____	+ 400 mV
Current Programming & Readback				
Minimum current (Iout):		- 4 mA	_____	+ 4 mA
Current measured over interface:		Iout - 4 mA	_____	Iout + 4 mA
High current (Iout):		12.4835 A	_____	12.5165 A
Current measured over interface:		Iout - 0.0165 A	_____	Iout + 0.0165 A
CC Load Effect:				
		- 0.8 mA	_____	+ 0.8 mA
Current Sink Tests				
10% of current rating:		- 1.2553 A	_____	- 1.2448 A
100% of current rating:		- 12.5165 A	_____	- 12.4835 A

**N6977A Settings**

Voltage Programming & Readback Min:	Voltage priority: 160 mV, 12.5 A
Voltage Programming & Readback High:	Voltage priority: 160 V, 12.5 A
CV Load Effect, CV Ripple and Noise:	Voltage priority: 160 V, 12.5 A
Transient Response:	Voltage priority: 160 V, 6.25 A to 12.5 A
Current Programming & Readback Min:	Current priority: 160 V, 0 A
Current Programming & Readback High:	Current priority: 160 V, 12.5 A
CC Load Effect:	Current priority: 160 V, 12.5 A
10% of current rating (Isink):	Current priority: 160 V, - 1.25 A
	External supply: 160 V, 1.375 A
100% of current rating (Isink):	Current priority: 160 V, - 12.5 A
	External supply: 160 V, 13.75 A

## N7976A and N6976A with Option 301

N7976A/N6976A Option 301 Test Record		Report Number _____	Date _____	
Test Description	Model	Min. Specs	Results	Max. Specs
Voltage Programming & Readback				
Minimum voltage (Vout):	Both	+ 109 mV	_____	+ 131 mV
Voltage measured over interface:	Both	Vout - 11 mV	_____	Vout + 11 mV
High voltage (Vout):	Both	119.953 V	_____	120.047 V
Voltage measured over interface:	Both	Vout - 47 mV	_____	Vout + 47 mV
CV Load Effect:	Both	- 4 mV	_____	+ 4 mV
CV Ripple and Noise				
peak-to-peak:	Both	N/A	_____	+ 9 mV
rms:	Both	N/A	_____	+ 1 mV
Transient response @ 100 $\mu$ s:	Both	- 300 mV	_____	+ 300 mV
Current Programming & Readback				
Minimum current (Iout):	Both	- 2.5 mA	_____	+ 2.5 mA
Current measured over interface:	Both	Iout - 2.5 mA	_____	Iout + 2.5 mA
High current (Iout):	Both	16.6908 A	_____	16.7092 A
Current measured over interface:	Both	Iout - 0.0092 A	_____	Iout + 0.0092 A
Low Current Measurement Range:	Both	Iout - 1.2 mA	_____	Iout + 1.2 mA
CC Load Effect:	Both	- 1 mA	_____	+ 1 mA
Current Sink Tests				
10% of current rating:	Both	- 1.6732 A	_____	- 1.6668 A
100% of current rating:	Both	- 16.7092 A	_____	- 16.6908 A

### N7976A/N6976A Option 301 Settings

Voltage Programming & Readback Min:	Voltage priority: 120 mV, 16.7 A
Voltage Programming & Readback High:	Voltage priority: 120 V, 16.7 A
CV Load Effect, CV Ripple and Noise:	Voltage priority: 120 V, 16.7 A
Transient Response:	Voltage priority: 120 V, 8.35 A to 16.7 A
Current Programming & Readback Min:	Current priority: 120 V, 0 A
Current Programming & Readback High:	Current priority: 120 V, 16.7 A
Low Current Measurement Range:	Current priority: 120 V, 1.67 A
CC Load Effect:	Current priority: 120 V, 16.7 A
10% of current rating (Isink):	Current priority: 120 V, - 1.67 A
	External supply: 120 V, 1.837 A
100% of current rating (Isink):	Current priority: 120 V, - 16.7 A
	External supply: 120 V, 18.37 A

**N7977A and N6977A with Option 301**

N7977A/N6977A Option 301 Test Record		Report Number _____	Date _____	
Test Description	Model	Min. Specs	Results	Max. Specs
Voltage Programming & Readback				
Minimum voltage (Vout):	Both	+ 146 mV	_____	+ 174 mV
Voltage measured over interface:	Both	Vout - 14 mV	_____	Vout + 14 mV
High voltage (Vout):	Both	159.938 V	_____	160.062 V
Voltage measured over interface:	Both	Vout - 62 mV	_____	Vout + 62 mV
CV Load Effect:				
	Both	- 4 mV	_____	+ 4 mV
CV Ripple and Noise				
peak-to-peak:	Both	N/A	_____	+ 9 mV
rms:	Both	N/A	_____	+ 1 mV
Transient response @ 100 µs:				
	Both	- 400 mV	_____	+ 400 mV
Current Programming & Readback				
Minimum current (Iout):	Both	- 2 mA	_____	+ 2 mA
Current measured over interface:	Both	Iout - 2 mA	_____	Iout + 2 mA
High current (Iout):	Both	12.493 A	_____	12.507 A
Current measured over interface:	Both	Iout - 0.007 A	_____	Iout + 0.007 A
Low Current Measurement Range:				
	Both	Iout - 0.875 mA	_____	Iout + 0.875 mA
CC Load Effect:				
	Both	- 0.8 mA	_____	+ 0.8 mA
Current Sink Tests				
10% of current rating:	Both	- 1.2525 A	_____	- 1.2475 A
100% of current rating:	Both	- 12.507 A	_____	- 12.493 A

**N6977A/N6977A Option 301 Settings**

Voltage Programming & Readback Min:	Voltage priority: 160 mV, 12.5 A
Voltage Programming & Readback High:	Voltage priority: 160 V, 12.5 A
CV Load Effect, CV Ripple and Noise:	Voltage priority: 160 V, 12.5 A
Transient Response:	Voltage priority: 160 V, 6.25 A to 12.5 A
Current Programming & Readback Min:	Current priority: 160 V, 0 A
Current Programming & Readback High:	Current priority: 160 V, 12.5 A
Low Current Measurement Range:	Current priority: 160 V, 1.25 A
CC Load Effect:	Current priority: 160 V, 12.5 A
10% of current rating (Isink):	Current priority: 160 V, - 1.25 A
	External supply: 160 V, 1.375 A
100% of current rating (Isink):	Current priority: 160 V, - 12.5 A
	External supply: 160 V, 13.75 A

# 8

## Service and Maintenance

**Introduction**

**Self-Test Procedure**

**Firmware Update**

**Option Installation**

**Instrument Sanitize**

**Calibration Switches**

**Battery Replacement**

**Redundant Ground for 400 Hz**

**Disassembly**

## Introduction

### Types of Service Available

If your instrument fails during the warranty period, Keysight Technologies will repair or replace it under the terms of your warranty. After your warranty expires, Keysight offers repair services at competitive prices.

Many Keysight products have optional service contracts that extend coverage after the standard warranty expires.

### Obtaining Repair Service (Worldwide)

To obtain service for your instrument, contact your nearest Keysight Technologies Service Center. They will arrange to have your unit repaired or replaced, and can provide warranty or repair-cost information where applicable. Ask the Keysight Technologies Service Center for shipping instructions, including what components to ship. Keysight recommends that you retain the original shipping carton for return shipments.

### Before Returning the Unit

Before returning the unit, make sure the failure is in the instrument rather than any external connections. Also make sure that the instrument was accurately calibrated within the last year (see [Calibration Interval](#)).

If the unit is inoperative, verify that:

- the AC power cord is securely connected to the instrument
- the AC power cord is plugged into a live outlet
- the front-panel Power On/Standby switch has been pushed

If self-test failed, verify that:

Ensure that all connections (front and rear) are removed when self-test is performed. During self-test, errors may be induced by signals present on external wiring, such as long test leads that can act as antennae.

### Repackaging for Shipment

To ship the unit to Keysight for service or repair:

- Attach a tag to the unit identifying the owner and indicating the required service or repair. Include the model number and full serial number.
- Place the unit in its original container with appropriate packaging material.
- Secure the container with strong tape or metal bands.

- If the original shipping container is unavailable, use a container that will ensure at least 10 cm (4 in.) of compressible packaging material around the entire instrument. Use static-free packaging materials.

Keysight suggests that you always insure shipments.

## Cleaning

**WARNING** SHOCK HAZARD To prevent electric shock, unplug the unit before cleaning.

Clean the outside of the instrument with a soft, lint-free, slightly damp cloth. Do not use detergent. Disassembly is not required or recommended for cleaning.

## Self-Test Procedure

### Power-On Self-Test

Each time the instrument is powered on, a self-test is performed. This test assures you that the instrument is operational.

Self-test checks that the minimum set of logic and power mesh systems are functioning properly. Self-test does not enable the output or place any voltages on the output. It leaves the instrument in the **reset state**.

### User-Initiated Self-Test

The user-initiated self-test is the same as the power-on self-test.

Front Panel Menu Reference	SCPI Command
Cycle ac power.	<b>*TST?</b>
If self-test fails, the front panel ERR indicator comes on. Press the Error key to display the list of errors.	If 0, self-test passed. If 1, self-test failed. If self test-fails, use <b>SYSTem:ERRor?</b> to view the self-test error.

For a list of errors, see [SCPI Error Messages](#).

## Firmware Update

### Firmware Versions

Version A.02.01.1256

The "A" version firmware can only be installed on instruments with serial numbers prior to MY59100101. Updates to the "A" firmware include:

- Added minimum and maximum power measurements.
- Added voltage compensation pole frequency setting.

Version B.02.01.1256 and later

The "B" version firmware can only be installed on instruments with serial numbers MY59100101 and later. Updates to the "B" firmware include:

- Firmware cosmetic elements are rebranded to Keysight.
- Support for an updated P600 processor board - only available on models starting with the above serial numbers.
- The BBR function is integrated on the processor board and can only be ordered as a factory-installed option.
- The BBR data can now be sanitized.
- The updated web GUI does not require Java applet support.
- Added minimum and maximum power measurements.
- Added voltage compensation pole frequency setting.

**NOTE**

Refer to **Instrument Identification** to determine which firmware version is installed on your instrument. Go to [www.keysight.com/find/APSfirmware](http://www.keysight.com/find/APSfirmware) for the latest firmware version.

### Software Required

To update the firmware you need to download the following two items onto your computer from the APS product page at the APS firmware link referenced above.

- The Universal Firmware Update Utility
- The latest firmware version

## Update Procedure

Once you have copied both items to your computer, proceed as follows:

1. Run the Universal Firmware Update Utility
2. Browse to the location of the firmware that you just downloaded. Press Next.
3. Select the interface that you are using to communicate with your instrument and enter the address or connections string. Press Next.
4. Verify that the information is correct for the instrument you are updating. Press Begin Update.

The update utility will now update the firmware and restart your instrument.

## Restricting Access

Note that you can restrict access to the instrument by the firmware update utility. This prevents unauthorized users from updating the firmware.

Front Panel Menu Reference	SCPI Command
Select <b>System\Admin\Update</b>  Check the Must log in as admin box.  This requires a user to log into the Admin menu before the firmware update utility performs a firmware update.	Not available

## Option Installation

**NOTE**

Be sure you have the latest firmware installed before you install any options . Refer to **Firmware Update** for more information.

The Option dialog lets you install a license key to activate options on your Advanced Power System. The available options are:

**14585A** - Control and Analysis Software. **N7900 models**

This software is available for download to your PC at [www.keysight.com/find/14585](http://www.keysight.com/find/14585). If you already have the 14585 software installed, make sure you have the latest version.

This software is available for free. There is a temporary license key available on the website that allows the 14585A software to be operated on your APS for 30 days. Beyond that time you must purchase a license key to allow continued use of the software.

To install the license key:

Front Panel Menu Reference	SCPI Command
Select <b>System\Admin\Options</b>	Not available
Select an option in the Option dropdown menu. Then enter the license key in the Key field.	

### Obtaining the License

To obtain the license, you must first purchase the 14575A accessory. After you have purchased the accessory, you will receive a Software Entitlement Certificate. When this is received, you can obtain the license.

To get the license key, log onto the website <https://software.business.keysight.com/asm> and follow the on-screen directions. These include:

1. Creating a user account (if not already set up).
2. Entering your Order and Certificate number (these appear in your Software Entitlement Certificate).
3. Entering the Host instrument's 10-character serial number (this is located on the rear panel of the instrument).
4. Selecting the software license for the instrument.

When you have completed the license request, a license key will be sent to your email. Enter the Access Key into the Key field of the Options dialog shown above.

## Instrument Sanitize

**NOTE**

This procedure is not recommended for use in routine applications because of the possibility of unintended loss of data.

This procedure sanitizes all user data except for the black box recorder data. It writes all zeros to flash memory and then performs a full chip erase as per the manufacturer's data sheet. Identification data such as instrument firmware, model number, serial number, MAC address, and calibration data is not erased. After the data is cleared, the instrument is rebooted.

If you cannot access the Admin menu, it may be password protected.

Front Panel Menu Reference	SCPI Command
Select <b>System\Admin\Sanitize</b>	<b>SYST:SEC:IMM</b>
Select Sanitize.	
Selecting Sanitize removes all user-data from the instrument and cycles power.	

### Turn-on after Sanitization

The first time the unit is turned on after it has been sanitized, several NVRAM checksum errors will be generated. These errors annunciate the fact that two files were missing, which have been recreated with default values. The next time the unit turns on, there should be no errors.

## Sanitizing the Black Box Recorder

For instruments with serial numbers MY59100101 and later, the above procedure sanitizes the black box recorder.

For instruments with serial numbers prior to MY59100101, the **System\Admin\Sanitize** command deletes the BBR log and snapshot files, but will not sanitize the Black Box Recorder drive.

To sanitize the N7908A Black Box Recorder drive requires that you removed the board from the instrument and destroy it (see **Black Box Recorder**).

When the BBR board has been removed from the instrument, use the front panel **System\BBR>Status** menu to remove the BBR accessory from the instrument's option list.

## Calibration Switches

### WARNING

**SHOCK HAZARD** Only qualified, service-trained personnel who are aware of the hazards involved should remove instrument covers. Always disconnect the power cable and any external circuits before removing the instrument cover. Some circuits are active with power for a short time even with the power switch off.

Two switches control the access to calibration commands. The switches are on the interface board and are accessible by removing the top cover. To access the calibration switches:

### Accessing the Calibration Switch

1. Remove the instrument cover as described under **Disassembly**.
2. The calibration switch is on the interface board near the ribbon cable. To change the calibration switch settings, use a small screwdriver to move the switches. As shipped, all switches are set ON.
3. Replace the top cover when finished.

### CAUTION

Do not use a pencil to move the switches. Any graphite dust that gets on the switches will conduct electricity.

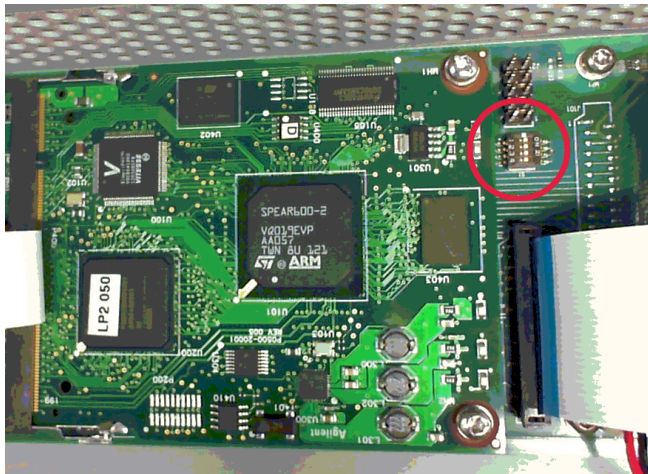

Serial numbers prior to MY59100101

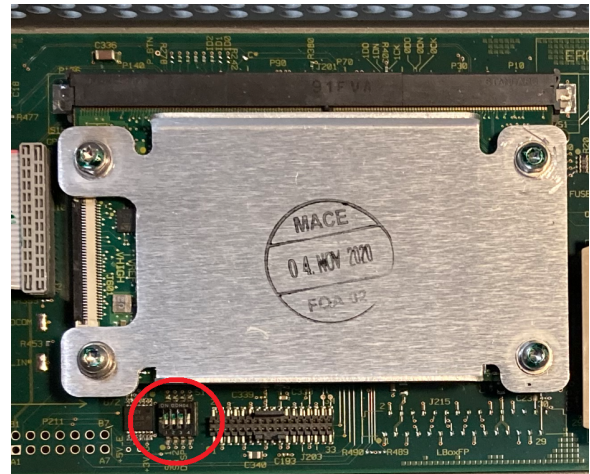

Serial numbers MY59100101 and later

## Switch Functions

Switches 1 and 2 set the calibration configuration as follows. Switches 3 and 4 are not used.

	Switch 1	Switch 2	Description	Switch View
Normal	ON	ON	This is the as-shipped setting. Calibration functions are accessible via a numeric password (default password is 0 (zero)).	
Clear Password	OFF	ON	The password resets to 0 when the instrument is first turned on. Use this setting if you have forgotten the password.	
Inhibit Calibration	ON	OFF	All calibration commands are disabled. This is useful where access is guarded by instrument seals.	

## Battery Replacement

**WARNING**

**SHOCK HAZARD** Only qualified, service-trained personnel who are aware of the hazards involved should remove instrument covers. Always disconnect the power cable and any external circuits before removing the instrument cover. Some circuits are active with power for a short time even with the power switch off.

The internal battery powers the real-time clock. The primary function of the clock is to provide a time stamp for the internal file system. If the battery fails, the clock and time stamp function will not be available. No other instrument functions are affected.

Under normal use at room temperature, the lithium battery has a life expectancy between seven and ten years. Note that battery life will be reduced if the instrument is stored for a prolonged period at temperatures above 40 degrees C.

The part number of the battery is Panasonic CR 2032.

### Installing the Battery

1. Remove the instrument cover as described under **Disassembly**.
2. The battery is located under the two ribbon cables.

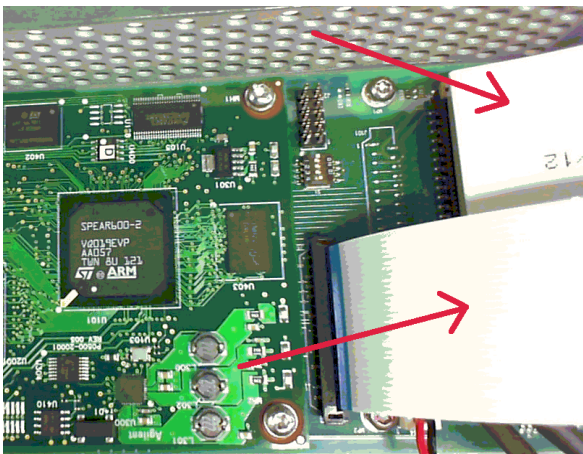

3. To access the battery, release the ribbon cables by pulling up on the locking tab.

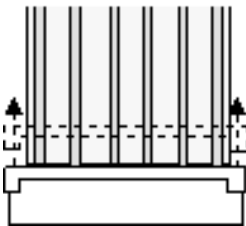

4. Use a flat-bladed screwdriver and carefully pry up on the side of the battery that is *opposite* the ribbon cable connector. Note that the location and orientation of the battery receptacle is slightly different for units with serial numbers MY59100101 and later.

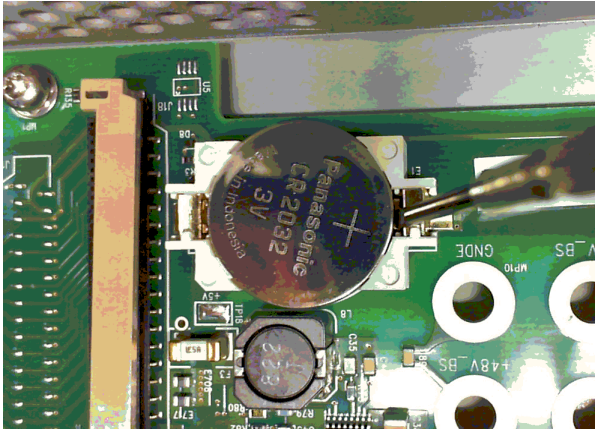

5. Install the new battery. Make sure that the positive side (+) is facing up. Place the battery *under* the small spring clips closest to the ribbon cable connector, then push down on the opposite end of the battery to seat the battery (see red arrow below). The top of the small spring clips should be visible after the battery is seated (see red circle below).

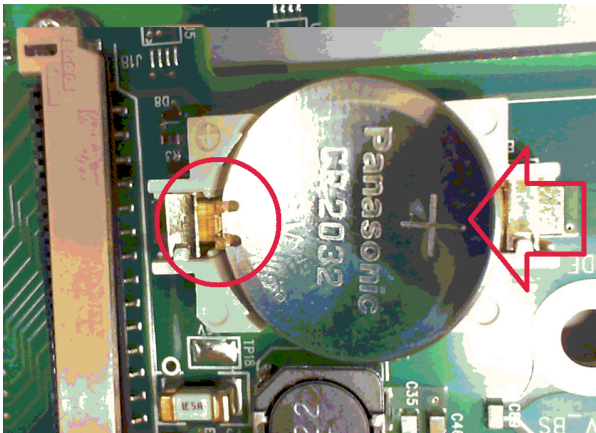

6. Replace the ribbon cables by fully inserting the cables into the connectors; then pushing down on the locking tab to secure the cables.
7. Replace the top cover when finished.
8. Reset the date and time (see [Clock Setup](#)).

**NOTE**

Properly dispose of the old battery in accordance with local laws and regulations.

## Redundant Ground for 400 Hz Operation

**WARNING**

**SHOCK HAZARD** Only qualified, service-trained personnel who are aware of the hazards involved should remove instrument covers. Always disconnect the power cable and any external circuits before removing the instrument cover. Some circuits are active with power for a short time even with the power switch off.

Operation at 400 Hz requires the installation of a redundant ground from the instrument chassis to earth ground. The redundant ground must be permanently attached to the unit as well as to the earth ground point.

The following procedure only describes how to make the permanent connection at the unit. The user must ensure the integrity and permanence of the connection at the earth ground point.

### Hardware and Tools Required (customer -supplied)

- Ground wire (14/16 AWG)
- Uninsulated ring terminal for attaching wire to unit (Tyco p/n 34124 or equivalent)
- Hardware for attaching ground wire to earth ground point
- 3/8 inch hex wrench

### Installation Procedure

1. Remove the instrument cover. Refer to [Disassembly](#).
2. Use the wrench and remove the rear panel binding post (1) from the chassis.
3. Crimp the appropriate ring terminal (2) onto the end of the ground wire.
4. Place the ring terminal onto the threaded end of the binding post. Re-install the binding post on the chassis with the washer and nut (3).
5. Rotate the ring terminal so that the ground wire does not interfere with any other connectors on the back of the unit. Use the wrench to tighten the binding post (Torque = 20 – 25 in.-lb.).

1 kW unit shown

On 2 kW units, the binding post is located directly above the blank cover plate

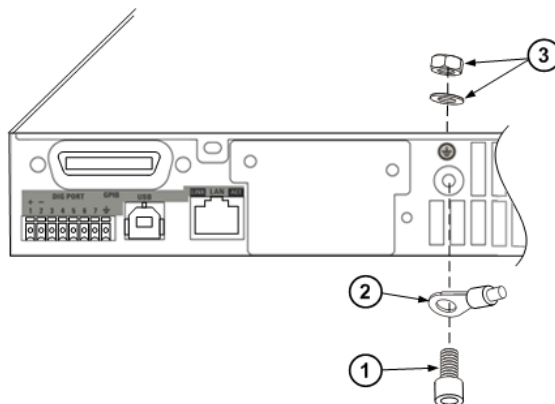

## Disassembly

**WARNING**

**SHOCK HAZARD** Only qualified, service-trained personnel who are aware of the hazards involved should remove instrument covers. Always disconnect the power cable and any external circuits before removing the instrument cover. Some circuits are active with power for a short time even with the power switch off.

### Electrostatic Discharge (ESD) Precautions

Almost all electrical components can be damaged by electrostatic discharge (ESD) during handling. Component damage can occur at electrostatic discharge voltages as low as 50 V.

The following guidelines will help prevent ESD damage during service operations:

- Disassemble instruments only in a static-free work area.
- Use a conductive work area to reduce static charges.
- Use a conductive wrist strap to reduce static charge accumulation.
- Minimize handling.
- Keep replacement parts in original static-free packaging.
- Remove all plastic, foam, vinyl, paper, and other static-generating materials from the immediate work area.

### Tools Required

- T10 Torx driver (cover disassembly)
- Small flat bladed screwdriver

### General Disassembly Procedure

1. Turn off the power. Remove all cables from the instrument.
2. Remove the 6 flat-head screws locate on the top, and the 14 pan-head screws on the sides (see figure below). Place the screws in a container so that you do not lose them.
3. Remove off the instrument cover.

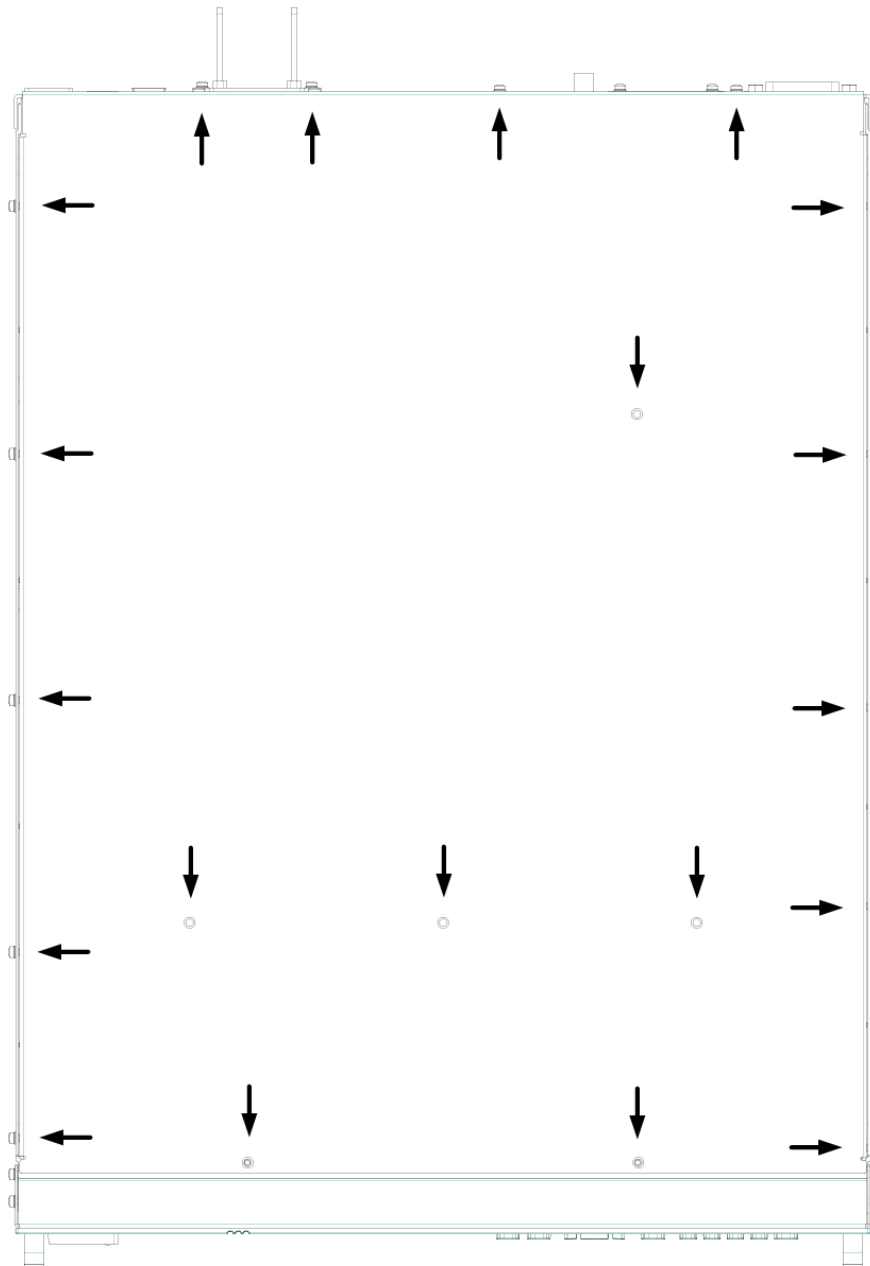

**Cover screws**

# Index

\*  
\*CLS 233  
\*ESE 233  
\*ESR? 234  
\*IDN? 234  
\*LRN? 234  
\*OPC 235  
\*OPC? 235  
\*OPT? 235  
\*RCL 236  
\*RST 236  
\*SAV 236  
\*SRE 237  
\*STB? 237  
\*TRG 237  
\*TST? 237  
\*WAI 238

## #

400 Hz 352

## A

ABORt Subsystem 210  
Air flow 67  
Amp-hour  
    measurements 134  
ARB Subsystem 211  
Average measurements 132

## B

Battery replacement 350  
Black Box Recorder 162

## C

CALibrate Subsystem 214  
Calibration 307, 316  
    interval 317  
    switches 349  
    test equipment 308

### Characteristics

    common 54  
    N6900 45  
    N6900N7900 high  
        voltage 52  
    N7900 49

Clear Status 296

CLS 233, 296

command language  
    quick reference 26, 202

Command Separators 204

Command Terminators 204

communication remote inter-  
    face 98

Compatibility  
    Commands 304

Connections  
    interface 86  
    parallel 76  
    power dissipator 83

    series 79  
    single unit 68

Contacting  
    Keysight 15

Current 94

Current sharing 167  
    calculations 182

Current sinking 174

CURRent Subsystem 218

customize protection shut-  
    down 116

## D

Data Logging 158

DC Offset 96

DC Offset Voltage 96

DIGital Subsystem 222

Disassembly 353

Display  
    lockout 178  
    saver 178

DISPlay Subsystem 225

## E

EDP

    excessive dynamic pro-  
        tection 112

End-Or-Identify 205

Environment 67

Error Messages 296

ESE 233

ESR? 234  
Example Programs 202  
Expression  
    constraints 147  
    defining 143  
    targets 146  
**F**  
Factory Reset 236, 296  
FETCh Subsystem 226  
FIFO 296  
Firmware Update 345  
First-in-first-out 296  
FORMat Subsystem 230  
front panel 17-18, 22  
front-panel menus 22  
FUNctIon Command 231  
**G**  
GPIB 296  
**H**  
HCOPy Subsystem 232  
Help 97  
Help system 97  
**I**  
I/O 296  
    queue 296  
IDN? 234  
IEEE-488 Common Com-

    mands 233  
Impedance graphs 56  
INITiate Subsystem 239  
Inspect 66  
Installation  
    Black box recorder 91  
Instrument  
    identification 177  
Instrument Sanitize 348  
Introduction 203  
    SCPI Language 203  
**K**  
Keywords 204  
**L**  
Legal information 11  
LIST Subsystem 240  
LRN? 234  
LXI Command 243  
**M**  
Maintenance 341  
Making Measurements 132  
MEASure Subsystem 244  
menus 22  
Message Available 237  
Models 37  
**N**  
Non-Volatile Settings 294

**O**  
OPC 235  
OPC? 235  
OPT? 235  
Options 39  
Options - installing 347  
Output  
    current 94  
    list 121  
    sequencing 127  
    transient 117  
Output Step 120  
OUTPut Subsystem 247  
Output Voltage 93  
over-current 112  
over-temperature 112  
Over-voltage 95  
over-voltage 112  
**P**  
Parameter Types 206  
Password  
    setting 179  
Power Assistant 186  
POWer Query 254  
Priority Mode  
    current 181  
    voltage 180

Programming

- ARB 125
- bandwidth 108
- current 107
- current sharing 167
- current sinking 174
- digital port 151
- priority 106
- protection 112
- resistance 109
- slew rate 107
- transients 117
- voltage 106

protection shutdown 115

## Q

Queries 204

Querying

- Status Byte Register 237

Questionable Data Summary 237

Queue 296

- I/O 296

Quick command

- reference 26, 202

## R

Rack mounting 89

RCL 236

rear panel 20-21

Redundant ground 352

REfERENCE 26

remote interface 98

Reset State 292

RESistance Subsystem 255

RST 236

## S

Safety 67

Safety Notices 13

SAV 236

SCPI 203

- quick reference 26, 202

SCPI Language 203

- Introduction 203

SCPI Status System 296

Self-test 237

Self-test procedure 344

SENSe Subsystem 256

Service 341

Set DC Offset Voltage 96

Set Output Current 94

Set Output Voltage 93

Set Over-voltage 95

Signal Routing 142

Software

- black box recording 198
- power assistant 186
- signal routing 189

SOURce Subsystem 263

Specificatons

- N6900 41
- N6900/N7900 high voltage 44
- N7900 42

SRE 237

Standard Event

- Summary 237

Standard Operation Register 237

Standard Operation Summary 237

State storage 177

Status Byte 237

Status Byte Register 237

Status Diagram 289

STATus Subsystem 264

Status Tutorial 285

STB? 237

STEP Command 269

Syntax Conventions 205

SYSTem Subsystem 270

## T

Temperature

- measurements 134

Test record forms 322

TRG 237

Trigger Diagram 291

TRIGger Subsystem 276

Trigger Tutorial 290

TST? 237

## U

user-protection 112

Using Device Clear 207

## V

Verification 307, 311

    test equipment 308

Voltage 93

VOLTage Subsystem 280

## W

WAI 238

Wait-for-trigger 237

Watt-hour

    measurements 134